

Pride of the Pacific Series **Curved Model**

Model PC812SG

GREENHOUSE INSTRUCTIONS

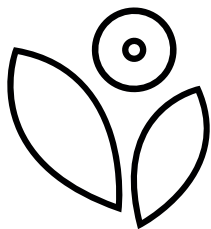

Greenhouse Style
CORPORATION

Telephone: 1-800-665-2124 | Fax: 1-888-273-1251

www.greenhousetyle.com • info@greenhousetyle.com

Contents

Foreword	2
User Notes	2
List of Drawings	3
Pride of the Pacific Component List	4
Foundations	5
Assembly Of The Aluminum Frame	
A. Back Gable End Assembly	6
B. Front Gable End Assembly With Door	8
C. Taping Glass bars With Foam	11
Aluminum Frame Installation	
1. Side Base/Sill	12
2. Front Gable End	12
3. Back Gable End	12
4. Ridge	12
4A. Truss Assembly Installation (if necessary)	See Appendix A
5. Glass bars With Sliders (#1 or #2)	13
6. Ventframe Angle	13
7. Glass bars	13
8. Gutter	13
9. Roof Purlin (Channel)	13
10. Center Bars	13
11. Tape All Glass bars	13
11A. Side Vents, Intake Shutter and Exhaust Fan Installation (if necessary)	See Appendix B - E
Glass And Cap Installation	
General Information	21
12. Glazing	21
13A-E. Side / Roof Glazing	21 - 25
14. Ends	25
15. Sealing The Greenhouse	25
Door And Vent Installation	
16. Door Installation	26
17. Vent Assembly	28
18. Vent Installation	28
Appendices: Optional Installations	
Truss Assembly	Appendix A
Intake Shutter	Appendix B
Exhaust Fan	Appendix C
Glass Louvre	Appendix D
Side Vent	Appendix E
Diagonal Brace	Appendix F
Purlin Installation	Appendix G
Greenhouse Bench	Appendix H
Side Vent	Appendix I
Roof Vent	Appendix J
Wire Shelving	Appendix K
Miscellaneous Assembly Details: 1-3	

Foreword

Your Pride of the Pacific greenhouse is designed and constructed to the highest engineering standards and provides structural strength and maintenance-free service for year-round gardening pleasure.

The Pride of the Pacific greenhouse must be built upon a firm, level surface. The greenhouse foundation or sill can be made from pre-treated timbers, concrete or bricks. Whatever your choice of material, the base must be square and level.

When selecting a site for your greenhouse, keep in mind that a flat, level site is essential so that the greenhouse can be easily installed and the complete structure is stable and secure. If possible, choose a site with proper water drainage.

Locating the greenhouse in a north-south position is most suitable for raising summer and autumn crops since the sun's rays will be on the greenhouse from daybreak until sunset. An east-west position is ideal for early spring and winter crops since the winter months, with shorter daylight hours, still allow six hours of light exposure to the greenhouse.

Try to locate your greenhouse for easy access, especially to the necessary power and water that is required for greenhouse gardening.

Please watch the enclosed video and follow the steps in this manual for your greenhouse installation. *Remember, if all else fails, read the instructions.*

User Notes

The Pride of the Pacific greenhouse structure has been designed to withstand extreme weather conditions such as high winds and accumulated snowfall. Hanging baskets and sidewall shelving can also be attached to its sturdy frame. The greenhouse design also makes it possible to add extra sections at a later date.

Once a year the greenhouse needs to be completely washed inside and out. You should do this task when your greenhouse contains the least number of plants, generally just before the garden plants are brought in for wintering over. A recommended cleaning solution is a mixture of hot water with a disinfectant such as Lysol or Pinesol. Any benches, shelving, plastic trays, pots and baskets should also be cleaned thoroughly. *Prevention is the best known method for controlling pests and diseases in the greenhouse.*

PLEASE NOTE: *The Illustrations found in this manual may not be specific to your greenhouse, however the detail of aluminum shapes are all consistent.*

The user notes are a generic instruction for all Pride of the Pacific Series Greenhouses – assembly instructions are common, only the sizes number of pieces and sizes vary.

List of Drawings

Pride Of The Pacific Component List	4
Foundation Styles	5
Back Gable End Line Drawing Assembly Procedure	6
Back Gable End Detail Drawing – <i>Details 1 – 8</i>	7
Front Gable End (With Door) Line Drawing Assembly Procedure	9
Front Gable End (With Door) Detail Drawing – <i>Details 1-12</i>	10
Taping Glass bars With Foam.	11
Assembly Outline: Aluminum Frame Steps 1-10	14 - 20
Glass Installation Steps 12-14	21 - 25
Door Installation.	27
Vent Assembly - Exploded View.	29
Greenhouse Architectural Details	31
Truss Assembly	Appendix A
Intake Shutter	Appendix B
Exhaust Fan	Appendix C
Glass Louvre	Appendix D
Side Vent	Appendix E
Diagonal Brace	Appendix F
Purlin Installation.	Appendix G
Greenhouse Bench	Appendix H
Side Vent	Appendix I
Roof Vent.	Appendix J
Wire Shelving	Appendix K

Pride of the Pacific Component List

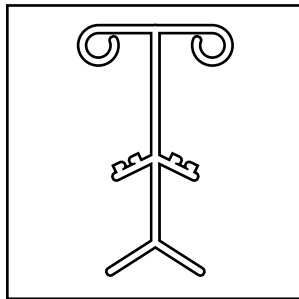

Ridge

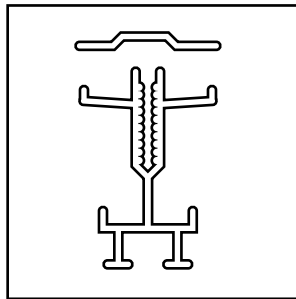

Glass Cap & Glass Bar

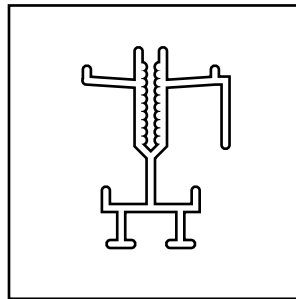

Glass End Bar

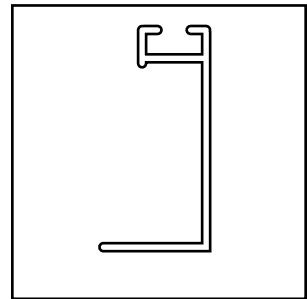

Ventframe Bottom

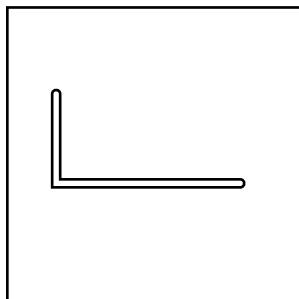

Bracing Angle

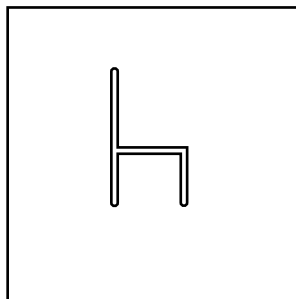

Plastic h came

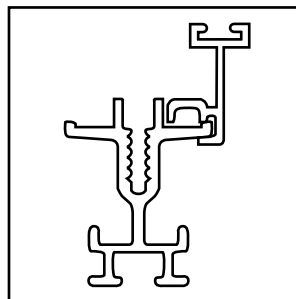

Vent Frame Sides

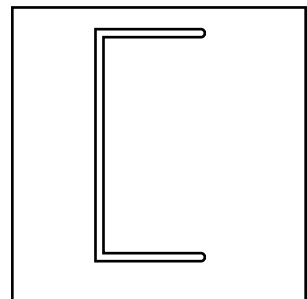

Purlin (if required)

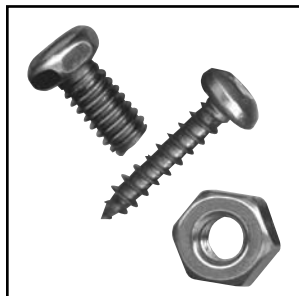

Screws and Bolts

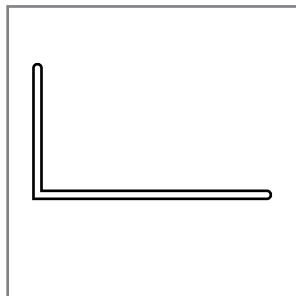

Base / Sill

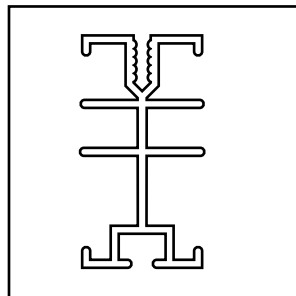

Door Frame

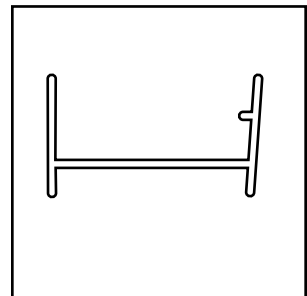

Gutter

Tools

- #2 Square head screw driver
- Measuring tape
- Level to check foundation
- 3/16" concrete bit (concrete foundation)
- 9/64" aluminum bit
- 7/16" wrench
- Razor blade cutter
- Caulking gun
- Ladder
- Hammer

Optionals

- Automatic Opener
- Circulating Fan
- Max/Min thermometer
- Benches
- Eyebolts
- Motorized Intake Shutter
- Exhaust Fan
- Thermostat
- Heater

Foundations

Check your local building codes for foundation requirements in your area.

CONCRETE FOUNDATIONS

When you prepare the concrete foundation, the size should be exactly the same as the outside dimensions of the greenhouse.

PRE-TREATED WOOD FOUNDATIONS

A greenhouse that is approximately 100 sq. ft. (9.3 m²) can be fastened to a 4" x 4" pre-treated wood timber foundation. For larger greenhouses, a 6" x 6" wood timber foundation is recommended. These timbers are placed on a 4" (10 cm) deep and 8" (20 cm) wide gravel bed. Wood timbers can be stacked to increase the height of the greenhouse. *One advantage of the wood foundation is that it is not classified as a permanent structure. Therefore, if you move, the greenhouse can be dismantled and moved to another location.* **IMPORTANT NOTE: Please see the last page of this manual for important information regarding the 'New' Pressure Treated wood.**

A SQUARE AND LEVEL FOUNDATION

Check the width and length of the foundation's outside dimensions. Then, square the foundation by measuring diagonally from opposite corners in the form of an "X". Next, use a *long* carpenter's level to check and adjust the foundation until it is level. Finally, measure where the door will be placed (in most cases it is 34¹/₂" wide). Mark these measurements on your foundation.

Foundation Styles

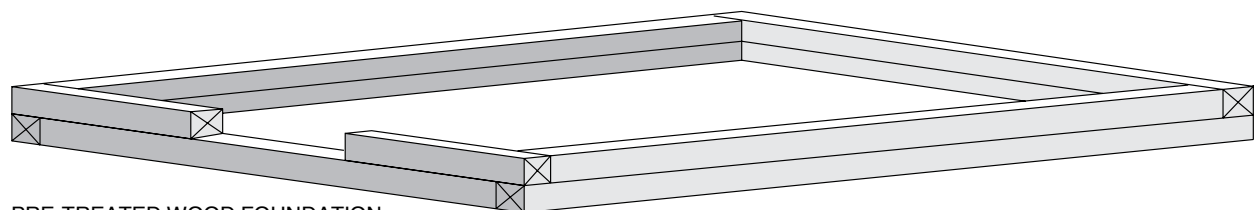
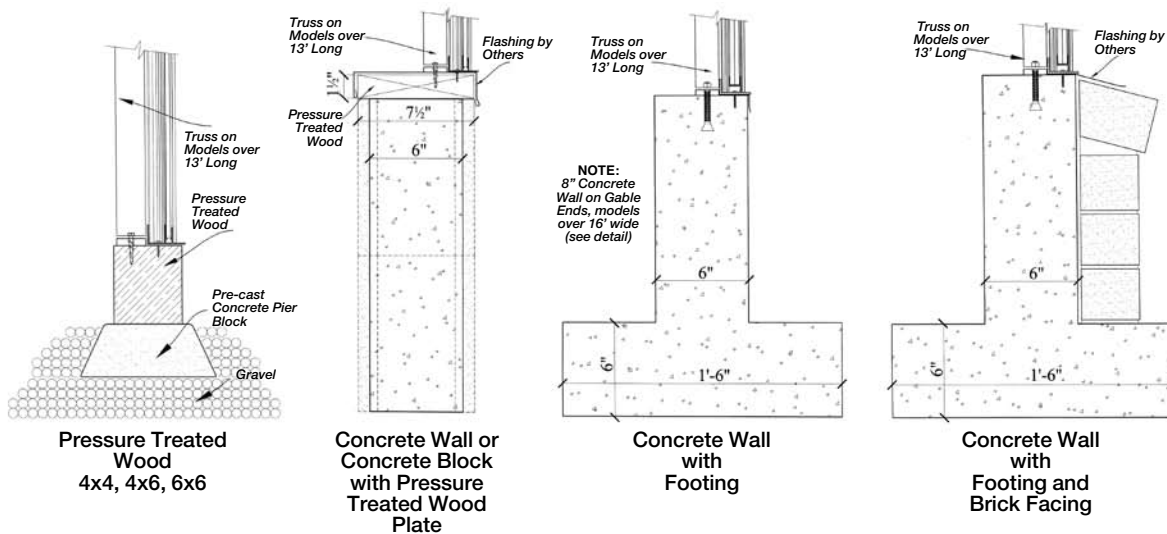

PRE-TREATED WOOD FOUNDATION

Pressure Treated Wood

WHAT IS NEW ABOUT PRESSURE TREATED WOOD?

As of January 2005, the chemicals used in pressure treated wood have been changed. Previous wood was treated with arsenic. However due to the potential long term health hazards this has been discontinued. New pressure treated wood is treated with copper.

The copper in the 'new' wood will be CORROSIVE TO ALUMINUM as well as other metals.

What are 'Greenhouse Friendly' solutions to the new pressure treated wood?

- 1 If you are using the new pressure treated wood, you must place a barrier between the wood and your aluminum frame. Popular barriers include 10 mil thick plastic sheeting, steel weather flashing, a rubber or foam weather membrane, or a row of weather resistant non-treated wood such as cedar or hemlock.
- 2 Other weather resistant non-treated woods are popular alternatives to pressure treated wood. These contain no harmful chemicals and will outlast pressure treated wood. Cedar timbers are a popular choice for greenhouse foundations.
- 3 Concrete foundations have always been suitable foundation alternatives for greenhouses. They can vary from poured concrete slabs, poured concrete perimeter walls to concrete block walls. Although these are usually more costly than wood alternatives, they have the benefit of lasting a lifetime. As they are usually considered a permanent foundation, it is important to check with your building codes to determine what you are able to build.

If you have any questions about using the 'New' pressure treated wood in conjunction with our aluminum greenhouses, please contact our office at 1-888-391-4433.

Assembly of Aluminum Frame

A. BACK GABLE END ASSEMBLY

Lay out the back pieces into the shape of the end wall. *Refer to the line/detail drawing.*

1. For the curved glass end bars, the flat surface should lie on the ground. *(See the example to the right.)*
2. Bolt the glass bars on the top first. *(See Page 7, Detail #2 & #4)* The center glass bar is not bolted to the top. You will notice an angle piece on the top of the glass bar (although it is not always pre-installed). This angle piece is for fastening to the ridge. *(See Page 7, Detail #3)*
3. Bolt the base/sill to the bottom of the glass bars. *(See Page 7, Detail #6)*
4. The angle brace is bolted approximately 54" from the base. The slider brackets that have already been screwed to the curved glass end bar will determine the height. *(See Page 7, Detail #1 & #8)* When bolting the center of the back wall, measure the back wall so that it does not sag. *(See Page 7, Detail #7)*

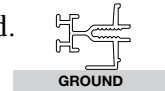

Back Gable End Line Drawing Assembly Procedure

1

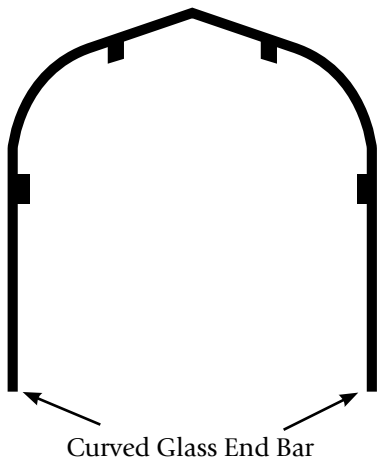

2

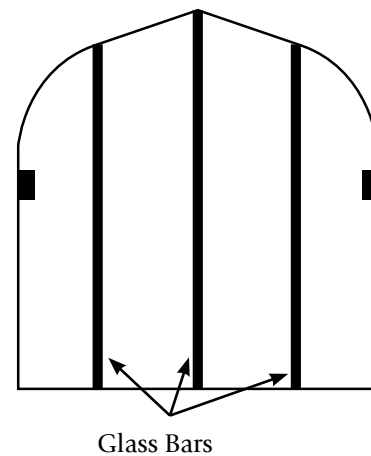

3

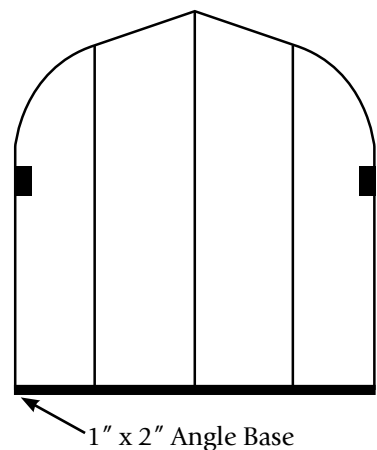

4

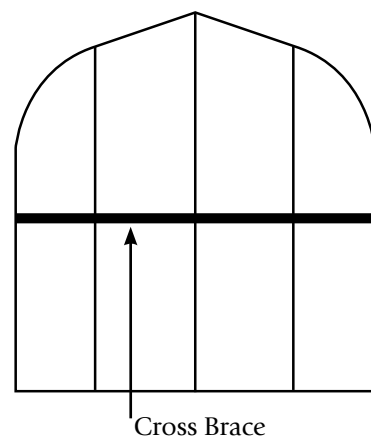

Back Gable End Detail Drawing – Details 1-8

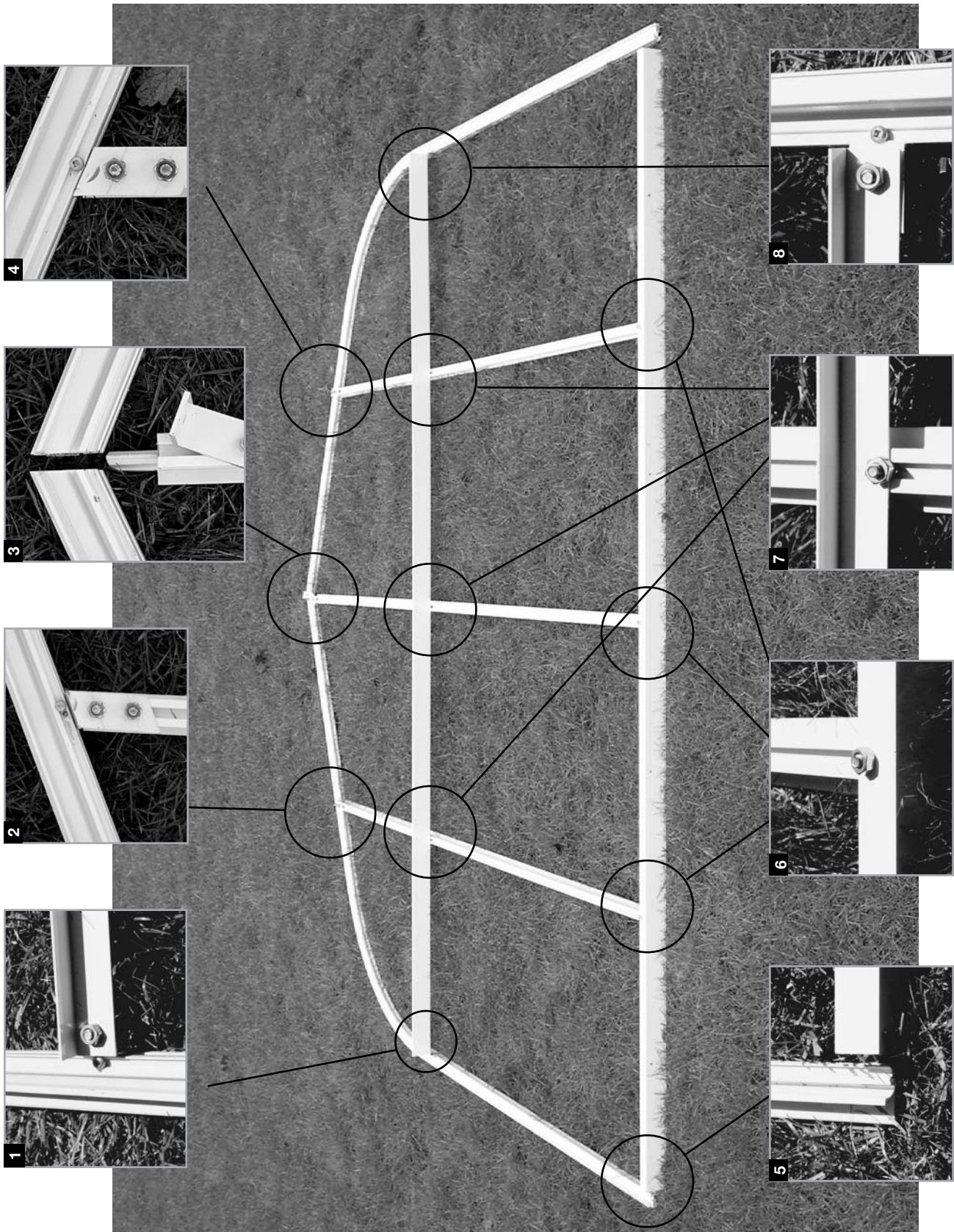

B. FRONT GABLE END ASSEMBLY WITH DOOR

1. Lay out the front pieces of the greenhouse into the shape of an end wall. The doorframe and all the glass bars have a track for the bolt. The track must face up when you assemble the gable ends. Slide the bolts into the track of the bars or use the notches that have already been punched out in the bars (*Refer to the line/detail drawing on the following page. The order of assembly is represented by dark lines, See Page 9*). When you are assembling the greenhouse, you can view the sketches and drawings from the inside the greenhouse. Bolt the bottom plates (*4 holes*) to the base/sill and the doorframe sides using 1/4" x 1/2" stainless steel bolts (*See Page 10, Detail #1 or #2*). Before tightening the bolts, be sure that it is square. (*If you ordered a greenhouse with a door drop, measure from the bottom of the doorframe to the underside of the base according to the specified distance.*)
2. At the top of the doorframe, put on the doorframe header (*which looks the same as the side pieces*). Put the header between the two side pieces and bolt on the plates (*6 holes*) (*See Page 10, Detail #3 & #4*). The plates should stick up 1" above the doorframe. Note how the plates are put on. Before tightening the bolts, be sure to square up the doorframe.
3. The 1" x 2" angle above the door (*49 3/4" long*) can now be bolted on. The 1/4" round holes should be lined up with the holes in the plates. Each end of the 1" x 2" angle has a slot punched out to accommodate the bolt. This slot lines up with the bolt track in the glass bars beside the door.
4. Take all the glass bars and bolt them to the base/sill (*See Page 10, Detail #12*). The angle cut on the glass bar should match the roof slope.
5. Each curved glass end bar has at least one small aluminum bracket attached to it with two 1/4" holes drilled in it. These pieces line up with the upright glass bar(s). Both sides are the same (*See Page 10, Detail #5 & #6*).
6. When the upright glass bars are fastened to the angle that is attached to the curved glass end bar, bolt on the short glass bar above the door to the 1" x 2" angle (*See Page 10, Detail #7*). Do not worry about the small cleat bolted on the bar. This will be fastened later.
7. The diagonal bracing can now be bolted on. Remove the bottom nut in the top plate and insert the brace. Then put the nut back on (*See Page 10, Detail #8 & #9*). There are 1/4" holes in the base, use 1/4" x 1/2" bolts to fasten the other end of the diagonal brace to the base (*See Page 10, Detail #10 & #11*).
8. Be careful when you stand up the front end of the greenhouse because the curved glass end bars are quite loose. It may have only two bolts in it. Wrap the bottom of the end bars to the base using a polywrap, or tape it if you are handling the end by yourself.

Front Gable End (with door) Line Drawing Assembly Procedure

1

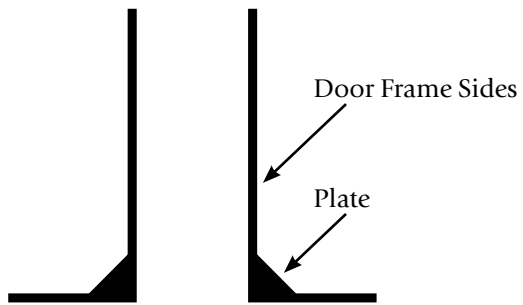

2

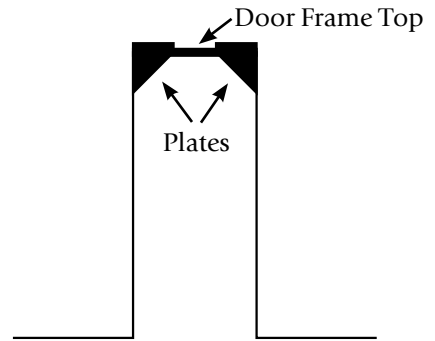

3

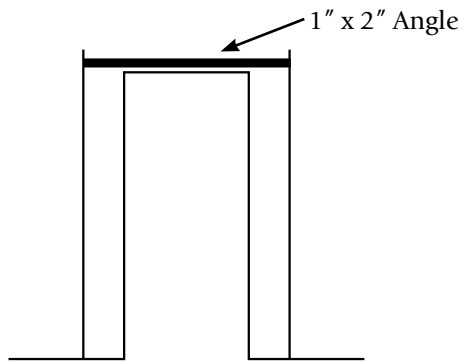

4

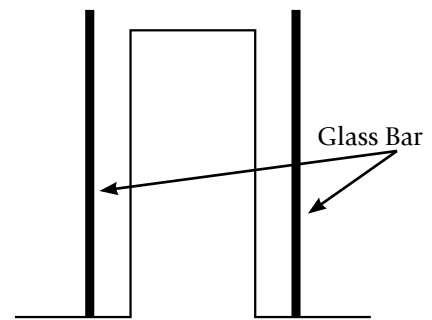

5

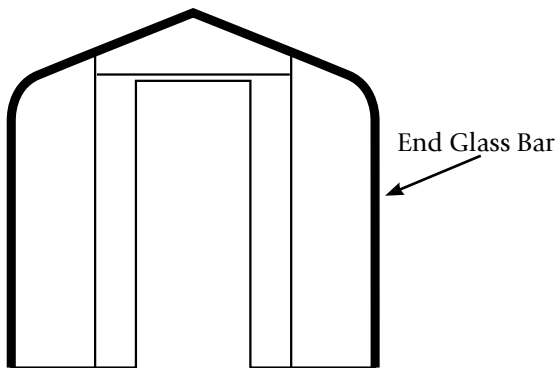

6

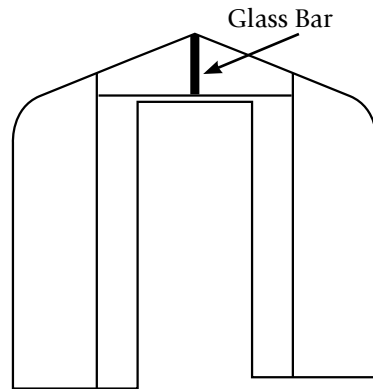

7

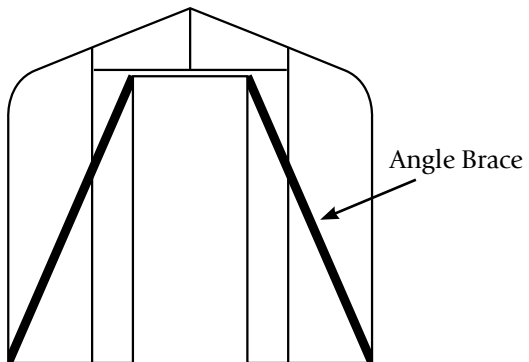

Front Gable End (with door) Detail Drawings Details 1 – 13

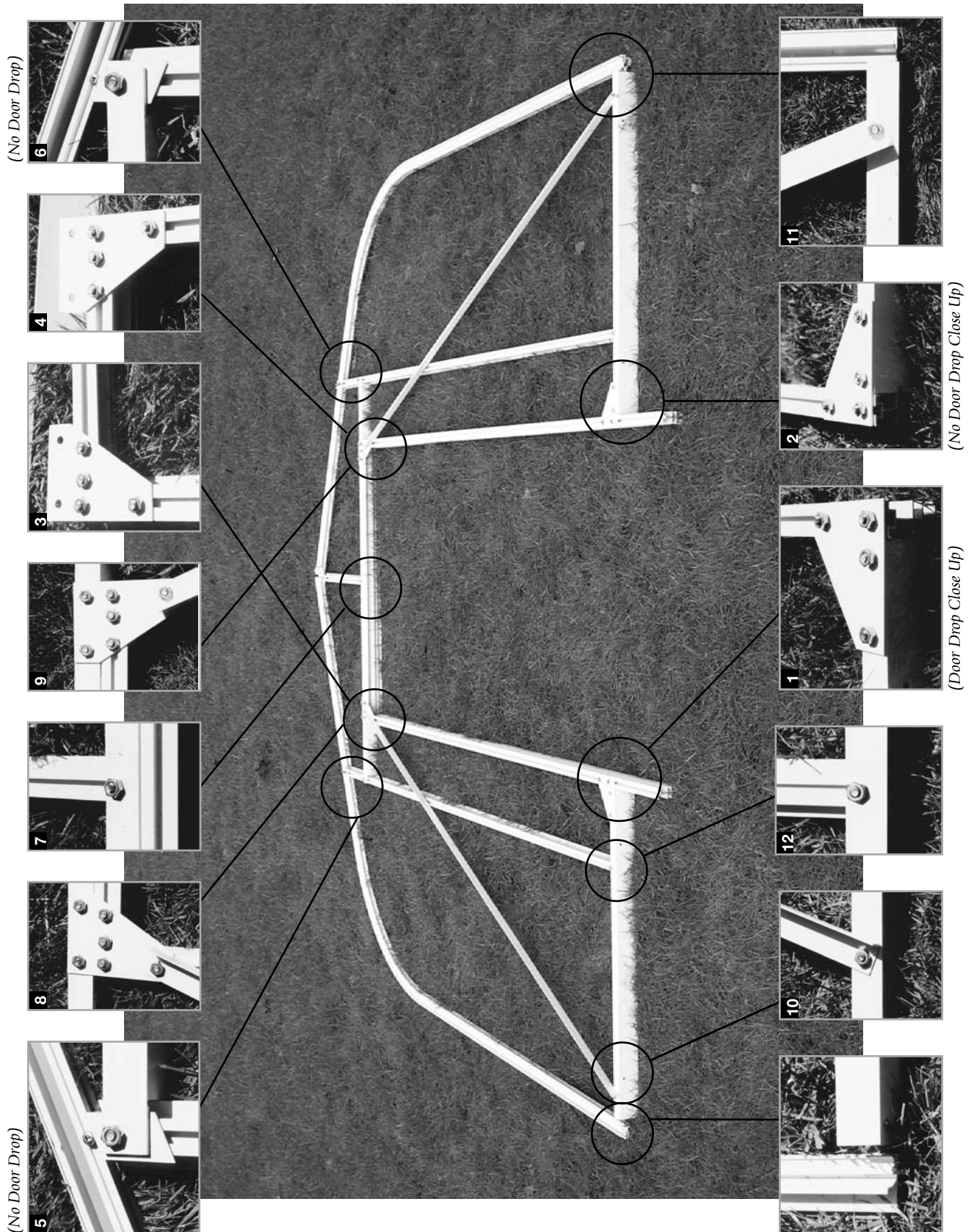

Door Frame Assembly

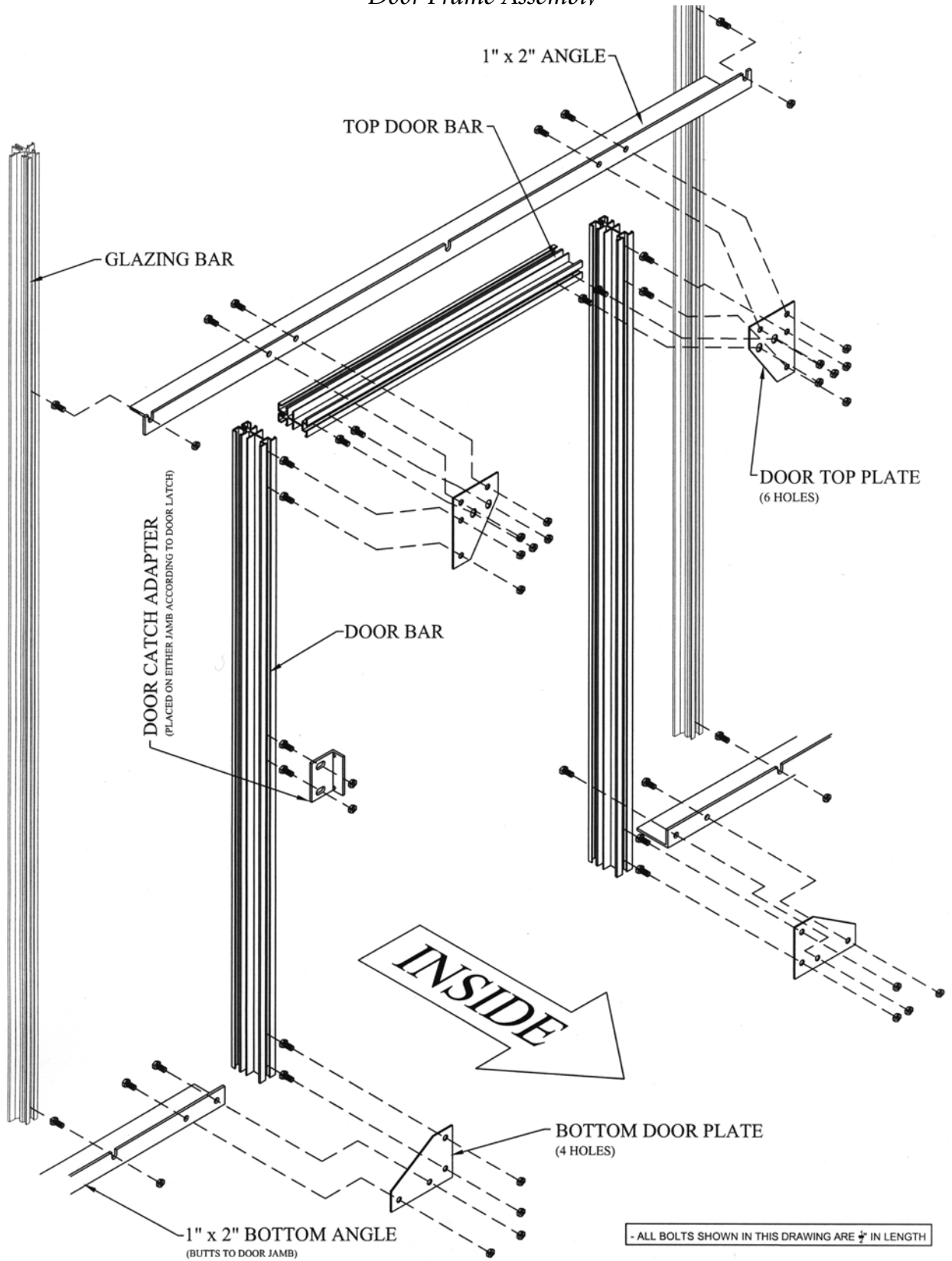

C. TAPING GLASS BARS WITH FOAM

Tape all the aluminum Glass Bars with 1/8" foam tape. The curved glass end bars tape on one side only. All other Glass Bars tape on both sides. Take a roll of tape and start at one end and press on the bar. *Make sure that the aluminum is dry.* Taping it at this time, you can still move all the pieces in the shed or undercover if it is raining.) Slowly roll down the tape toward the outer edge and press it down at the same time. (See pictures below) Be careful because sometimes the edge of the paper is quite sharp. Do not remove the paper until later.

NOTE: Do not tape the place where the Glass Bar is notched out.

When all bars are completed, including the end walls, go to Step #1 of the aluminum frame installation on the next page.

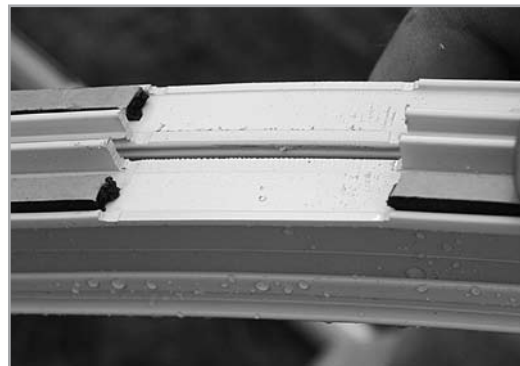
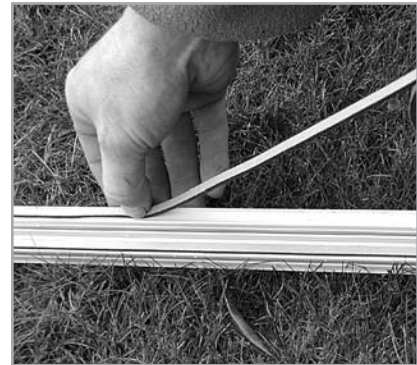
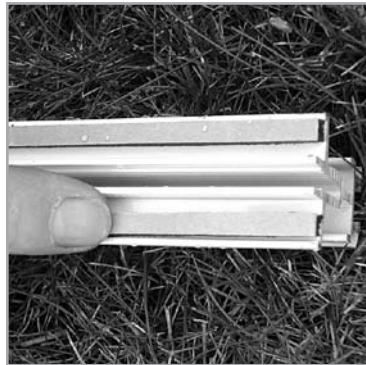
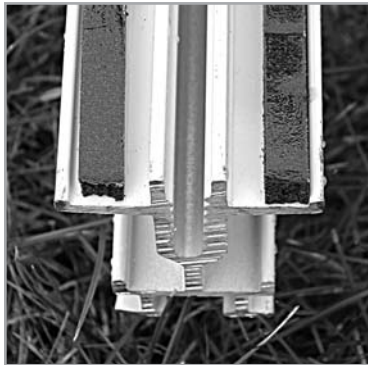

Do NOT put foam tape along the End Bars. The glass slides under the lip and needs to be sealed when the greenhouse is finished

Aluminum Frame Installation

Check that the foundation is level and square. If your foundation is larger than the greenhouse, mark a line on it with a pencil or with a chalk line. Take a caulking gun and put in a tube of caulking. Cut 1/4" off the top at a 25-degree angle. Then put a bead of caulking on your foundation approximately 1" in from the outside of the foundation or the marked line. **DO NOT CAULK THE DOOR OPENING.** Measure your door opening in the front.

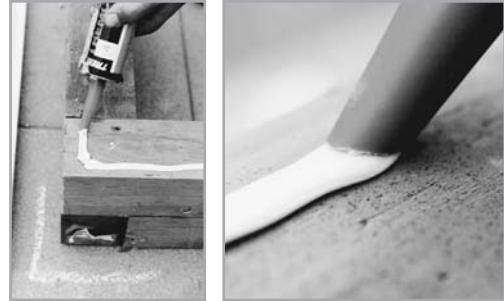

1. SIDE BASE/SILL

Lay down the aluminum side base/sill flush with your base on the line you have marked out. Push down on it so that the caulking squeezes out. *(See Step 1 Detail, page 14.)*

2. FRONT GABLE END

Stand up the front end between the side pieces flush with your base or marked line. Slide up one bolt in the bottom of each glass end bar (*front*). Take the end bar and push it into the side base where it is notched. The back of the bar lines up with the first slot in the side base/sill. Slide the bolt down and fasten it. Do the same for the other side. When you are lined up and in the right place, screw down the front base/sill using the screw holes that are already there. Then put one screw in the side base on each side of the front gable end. When you have fastened down the front, it should stand by itself. *(If it is windy, you will need another person to hold up the front, or you can use a stepladder so that the front can lean against it.)* *(See Step 2 Detail, page 14.)*

3. BACK GABLE END

Follow the same procedure for the back gable end as you did for the front. When you have bolted it to the side base and it lines up flush with your base/sill or marked line, then you can proceed. Fasten the base/sill down to your foundation with the screws that are provided. When fastening the side/base sill to the foundation, be sure that the base is straight. *(See Step 3 Detail, page 14.)*

4. RIDGE

Before you slide in the ridge, put one bolt in the top of each end bar. Take the ridge (one person at each end) and slide it between the end bars on the top. You will notice the punched-out slots in the bottom flange of the ridge. The slots on the end line up with the bottom side of the curved glass end bar. Now slide in the ridge and slide the bolt into the ridge slot. Make sure that the glass end bar is tight against the ridge. *(See Step 4 Detail, page 15.)*

4A. SEE APPENDIX A FOR TRUSS ASSEMBLY INSTALLATION FOR GREENHOUSES LONGER THAN 16 FEET.

5. CURVED GLASS BAR WITH SLIDERS (#1 OR #2)

Each glass bar is marked with a number (1, 2, 3 . . .) to correspond with the number on the ridge. Slide the bolt into the top of the glass bar and line it up with the slot in the ridge. Move up the bolt and fasten it. Do the same for the bottom of the glass bar. Slide in the bolt, push it down against the side base/sill. Bolt it on. Do this for all the glass bars with sliders and numbers (*The end of the bar should be tight to the base and ridge*).

(See Step 5 Detail, page 16)

6. VENTFRAME ANGLE

The ventframe angle is 50" long with the ends cut out to fit between the two glass bars with sliders. Put the head of the bolt into the punch out in the glass bar (24" from the top), slide the bolt up and fasten it to the ventframe on the bar. Make sure that the angle flanges are facing toward the sidewall (down) and that it is pushed up against the side sliders (already on the glass bar). Do this for all of them.

(See Step 6 Detail, page 17)

7. GLASS BARS

Bolt on all the remaining glass bars. Make sure that the top and bottom is tight against the ridge and base.

(See Step 7 Detail, page 18)

8. GUTTER

The gutter is also used as a spacebar. The gutter is located just below the curve approximately 54" up from the base (*The glass bar should be notched out for it*). Use #8 x 1/2" screws to fasten the gutter to the glass bar (*Keep the gutter to the top of the notch*). (See Step 8 Detail, page 19)

9. ROOF PURLIN (CHANNEL)

When installing the roof purlin, mark it out by measuring from the ridge. The roof purlin should be located (*refer to drawings for purlin placement*). In larger greenhouses, the purlin may be located about the center between the ridge and the top of the curve. Always face the open end of the purlin up towards the ridge so that it can be used for hanging baskets. Every glass bar has notches punched out so that the head of the bolts can be inserted and can slide up or down on the bar.

(See Step 9 Detail, page 20)

10. CENTER BARS

Fasten the center glass bar in each end wall. Use a 1" x 2" x 1" small angle with a 1/4" hole drilled in the 2" side. Put a bolt in the center glass bar and attach the small angle to it. Slide it up to the ridge. *It will be on a 24-degree angle*. Clamp it on with vice grips. Then drill a 9/64" hole in the ridge and screw on the glass bar. Make sure that the glass bar lines up the same as the other bars in the front and back. *The 10-foot wide Pride of the Pacific Model does not have this center bar in the back wall.*

(See Step 10 Detail, page 20)

11. TAPE ALL GLASS BARS

Complete all taping with the 1/8" foam gasket. **NOTE:** *Side vents need to be installed before taping the bars.*

(See photographs, page 12.)

11A. SIDE VENTS, INTAKE SHUTTER AND EXHAUST FANS INSTALLATION (IF NECESSARY) SEE APPENDIXES B THRU E. THEN RETURN TO THE NEXT PAGE AND CONTINUE

Assembly Outline



Step 1: Side Sill & Base

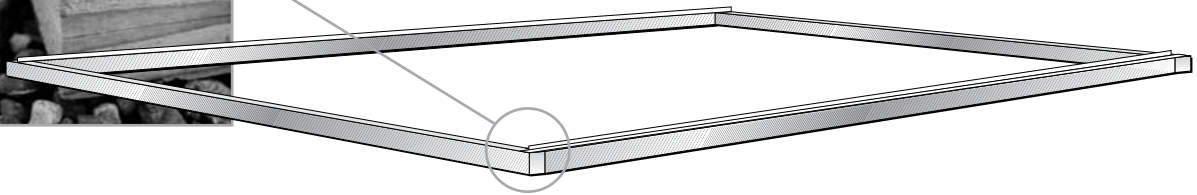

Step 2: Front Gable End



Step 3: Back Gable

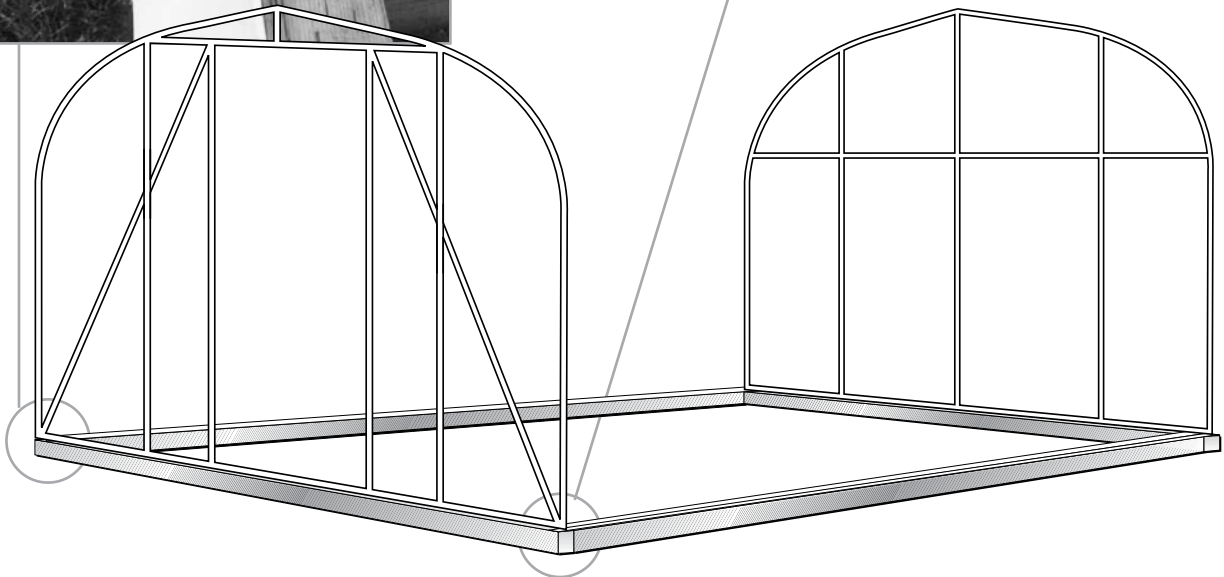

Step 4: Ridge

Outside View



Inside Front View



Back Inside View

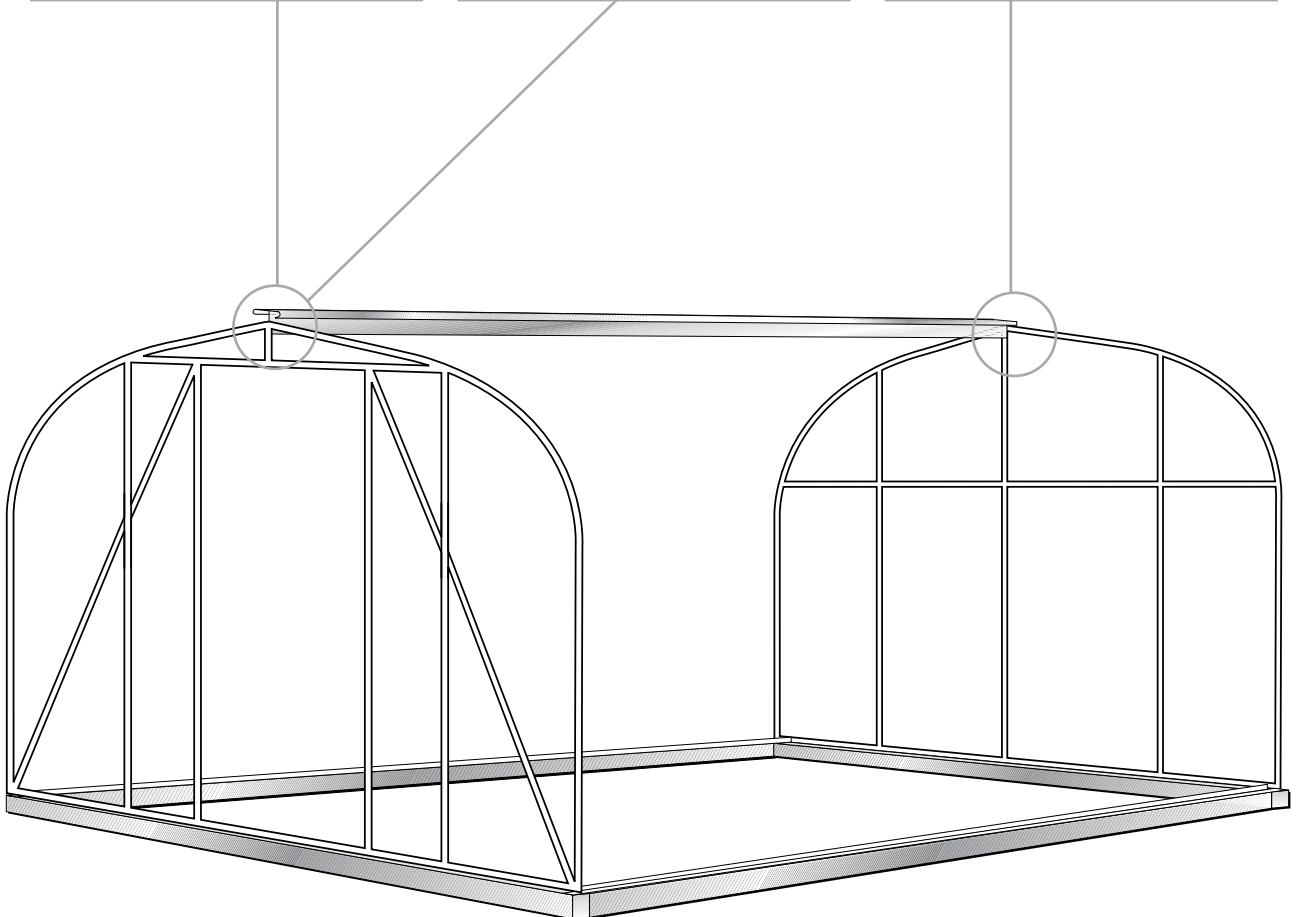

Step 5: Glass bar with Vent Frame Sliders

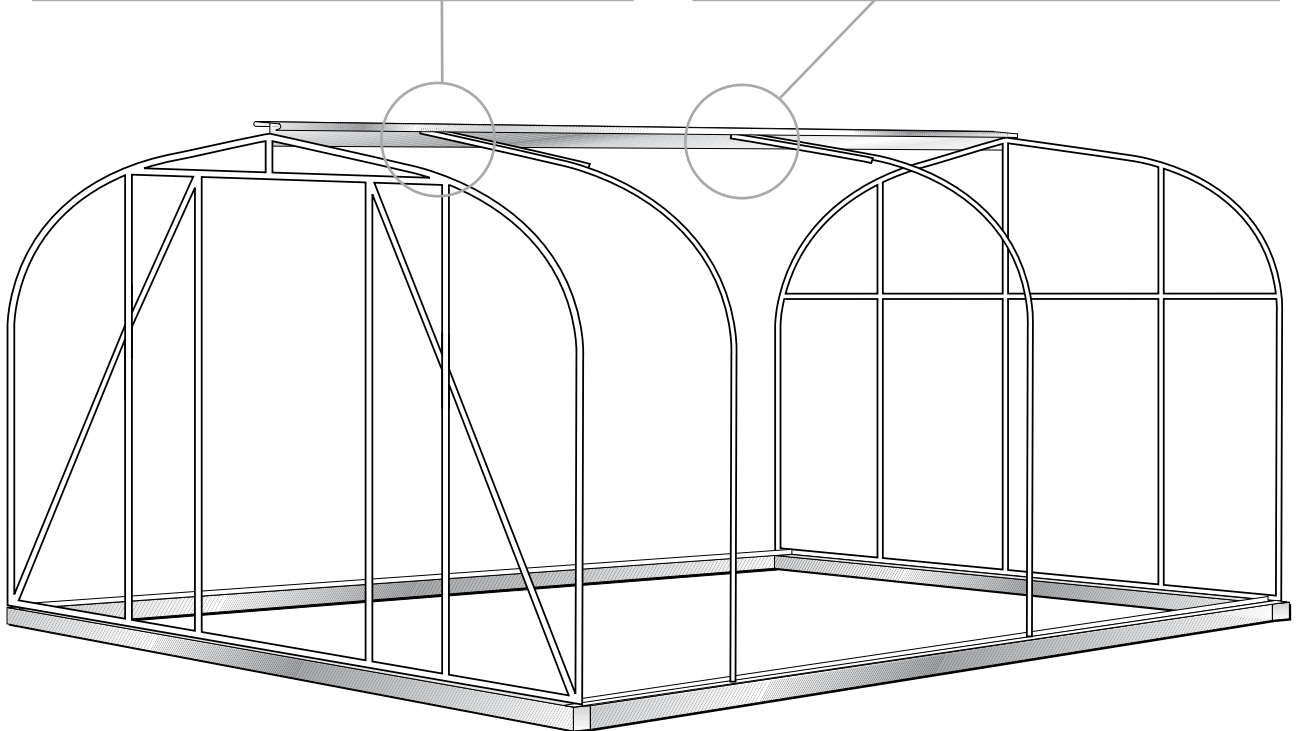
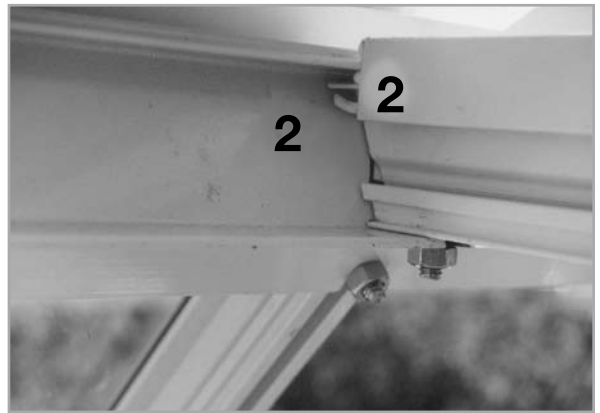
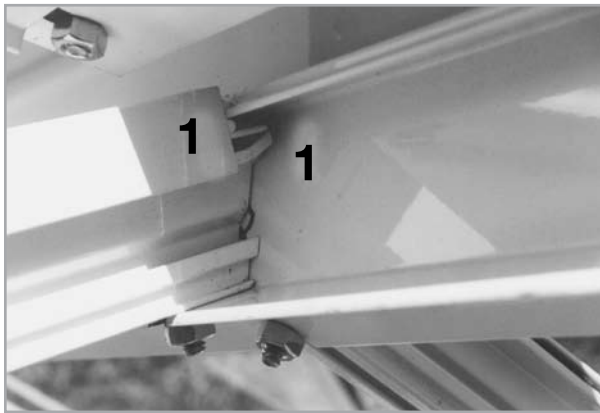

Step 6: Vent Frame Bottom

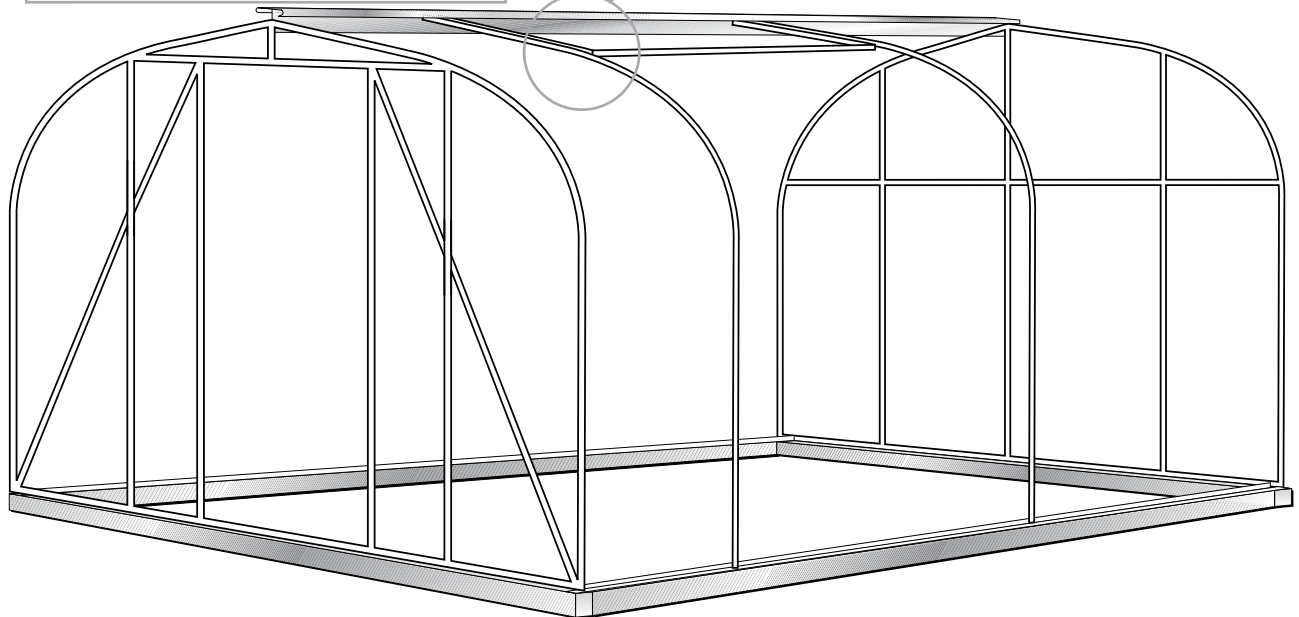
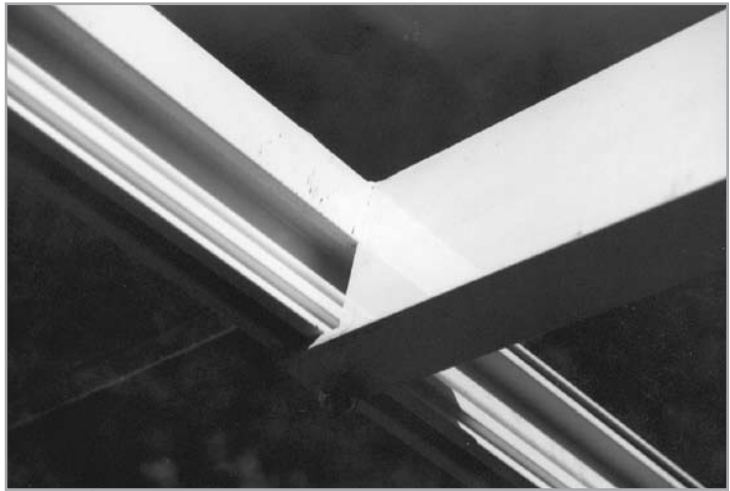
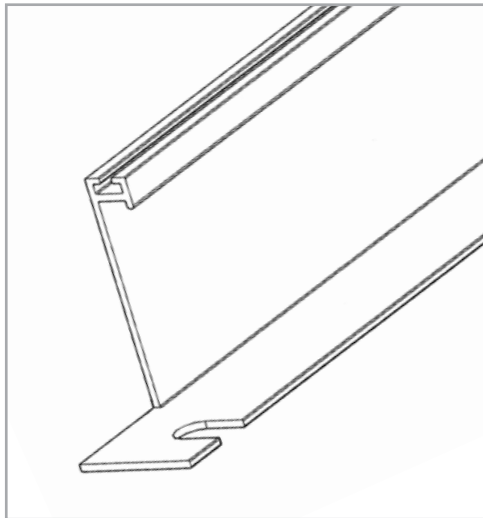

Step 7: Install All Remaining Glass Bars



*Apply
the foam
tape to
the Glass
Bars
before
installing*

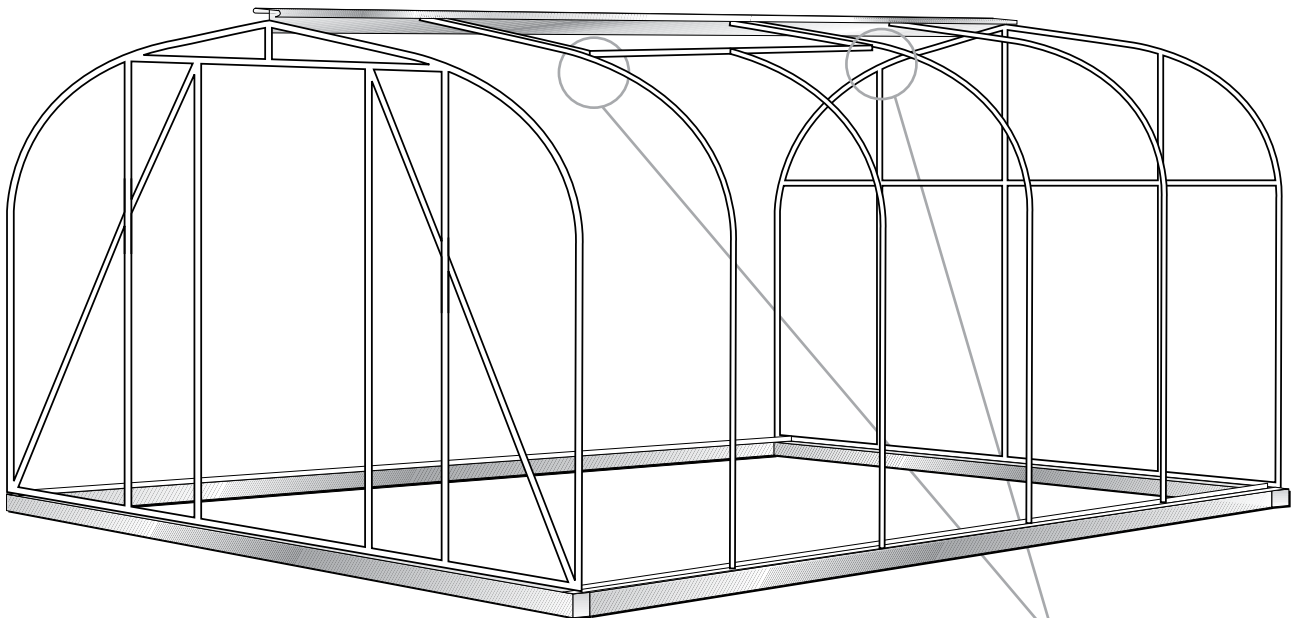

Step 8: Gutter

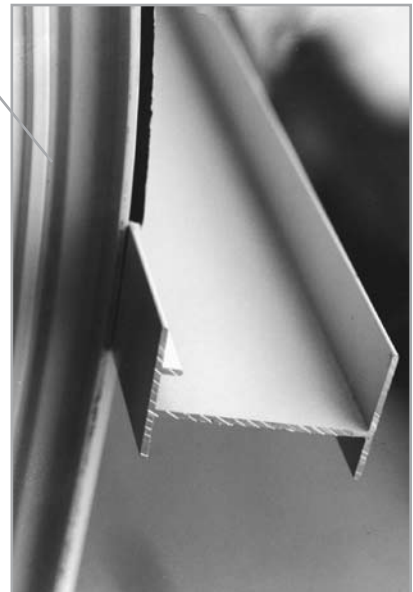
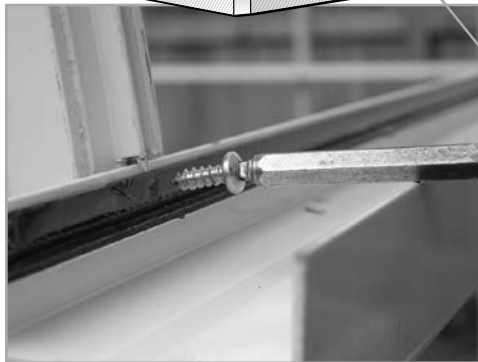
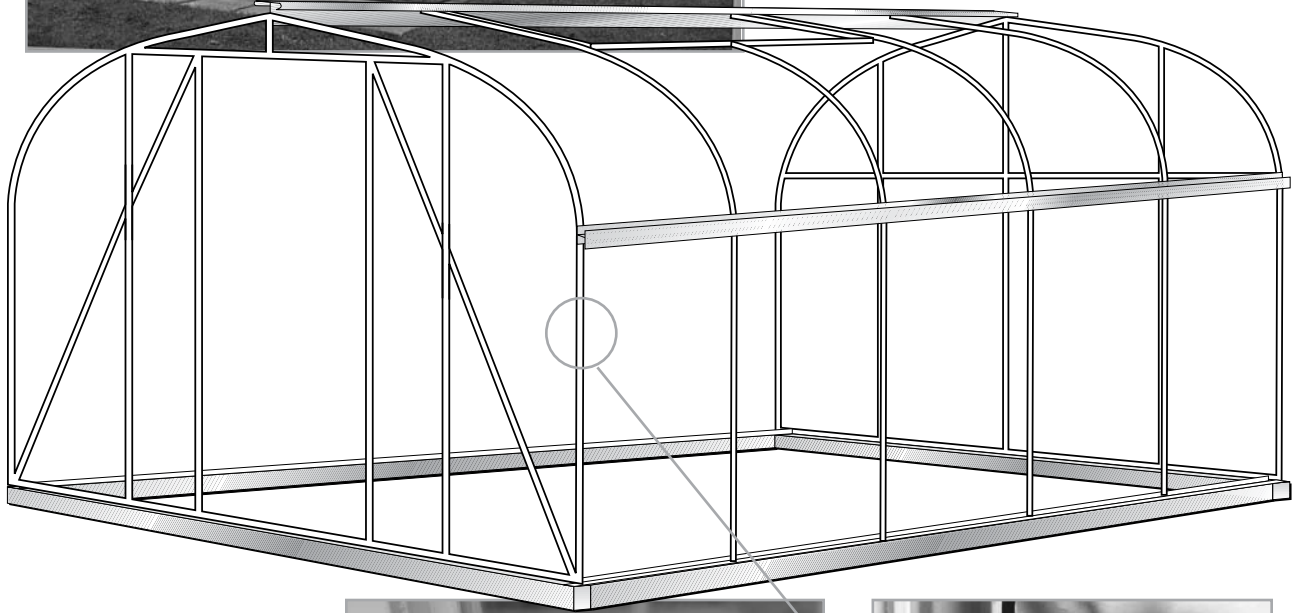

Step 9: Roof Purlin

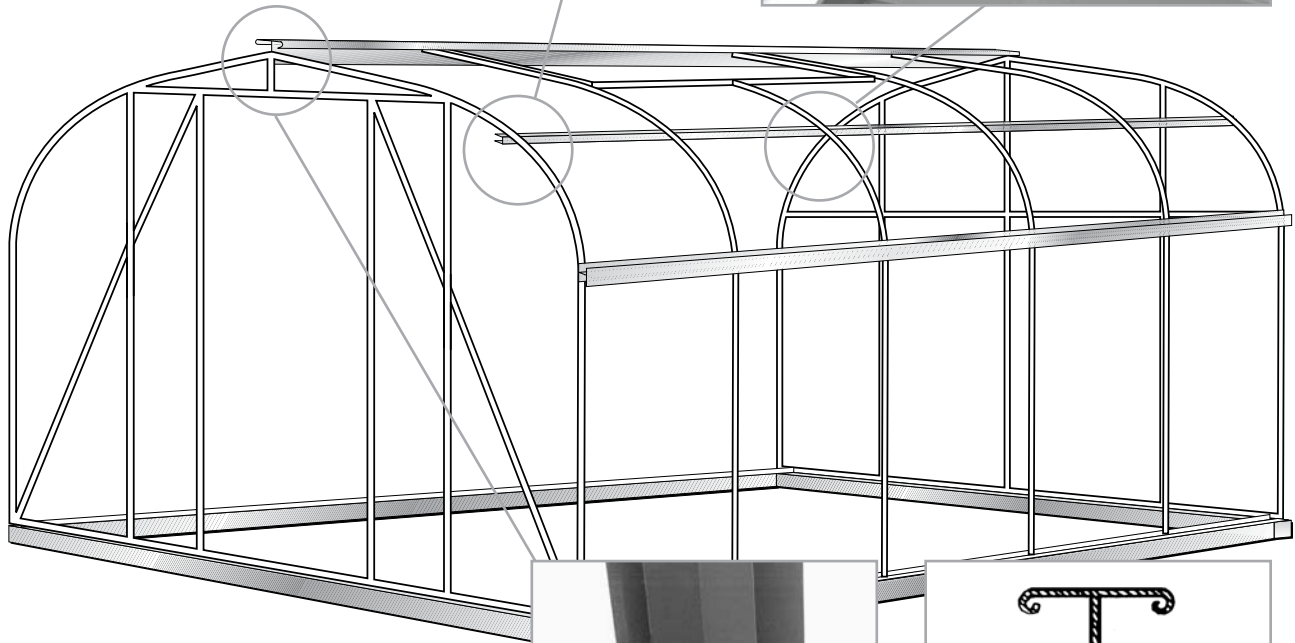

*Step 10:
Inside View
Angle Cleat
to Ridge*

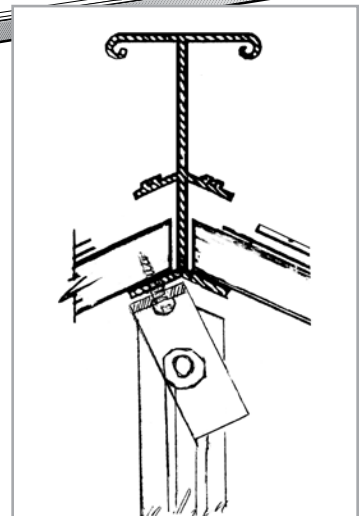

Glass & Cap Installation

GENERAL INFORMATION

Glass comes packaged in cardboard cases. When storing glass, put it upright against a wall or post. All glass is a 3mm / 24 oz. thickness (unless it is a special order). When handling glass, put one hand on the bottom and one hand on the side. Do not hold the glass flat on your hands. When laying out the glass for your greenhouse, do not lay the glass on your lawn while the sun is shining because the glass may burn the grass. (The following boxes **■** indicate the picture or illustration that will assist you with your assembly.)

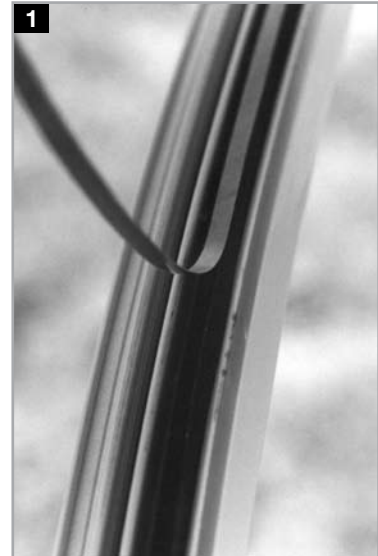

12. GLAZING

Remove all paper from the foam strips. **1**

13. SIDEWALLS (see the glass sketch for sizes)

- A. Take a piece of glass and hold it along the long side. Set the 24" width of the glass on your aluminum base against the glass bar and push it gently toward the greenhouse, (Page 22 **2**). If the greenhouse is not square, push the gutter over to square it. If it is a warm day, the

foam will stick to the glass and you can walk away and get your aluminum cap. The cap (see sketch for length) is pushed against the glass. Use #8 x 3/4" screws to fasten the cap to the glass bar. Hold the cap against the glass and put in your screws. When the

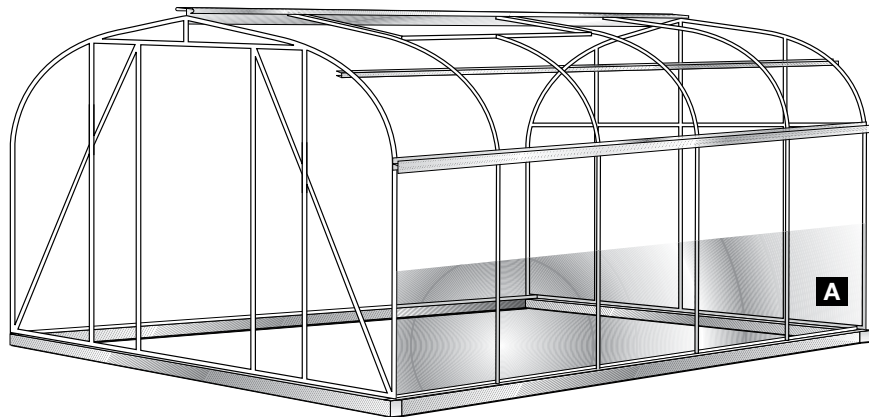

screw hits the cap, make a 1/4" turn. In other words, *do not tighten the screws too tightly*. Also, do not put a screw in the top hole of the cap. When the first piece of glass and cap is installed, go to the next bay. Finish off the bottom row on one side only. Open the bundle of plastic "H" and push one over the edge of the glass, (Page 22 **3**). Sometimes the plastic "H" is a little too tight to push on. If so, use a screwdriver to open it up a little, (Page 22 **4**) (See the pictures on the next page). **NOTE:** If you want to firm up the greenhouse, install the bottom row of end glass at the same tie as the side glass.

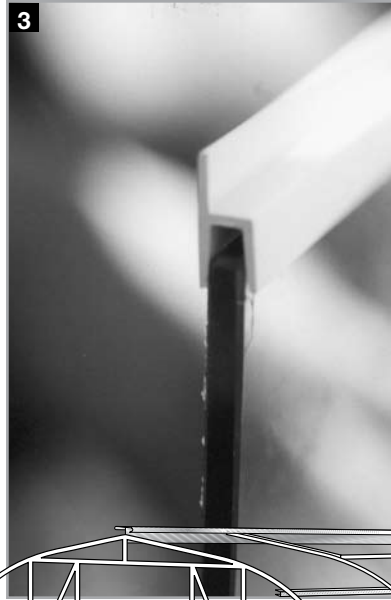

B. Install the next row of glass, setting it on top of the plastic "H". Take the aluminum cap (for length, see the sketch). Use the bottom hole of the second row of caps and line it up with

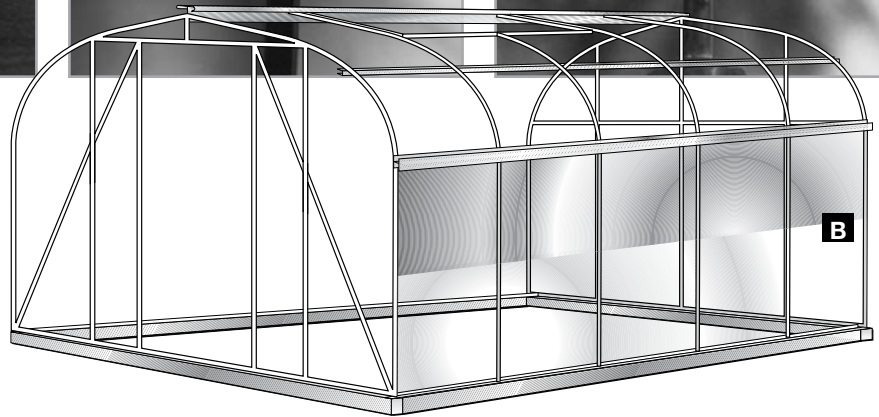

the top hole of the first row of caps. Again, do not tighten the screw too tightly. For a standard greenhouse, this row will finish off the sidewall below the gutter. Sealing off the glass against the gutter is done at a later time.



- C. Set the curved glass inside the gutter on the lip that is sticking out. When you set the curved glass on the gutter **5**, push the glass towards the aluminum frame. The frame may not be exactly square, so go to the ridge and push

it over to make it square to the glass. Work carefully as the curved glass does not have as much bending tolerance as flat glass. When you fasten on the aluminum cap, do not screw it too tightly. You do not want to put too much pressure on the glass. When an aluminum glass bar is bent, the tempering of the aluminum may vary somewhat and the glass bar may not be *exactly* the same radius as the glass. Therefore, you need to take extra care when you install the curved pieces. If the glass does not fit solidly onto the foam rubber, just lift the glass off, put on a second row of foam (usually in the middle of the curve) and reinstall the glass.

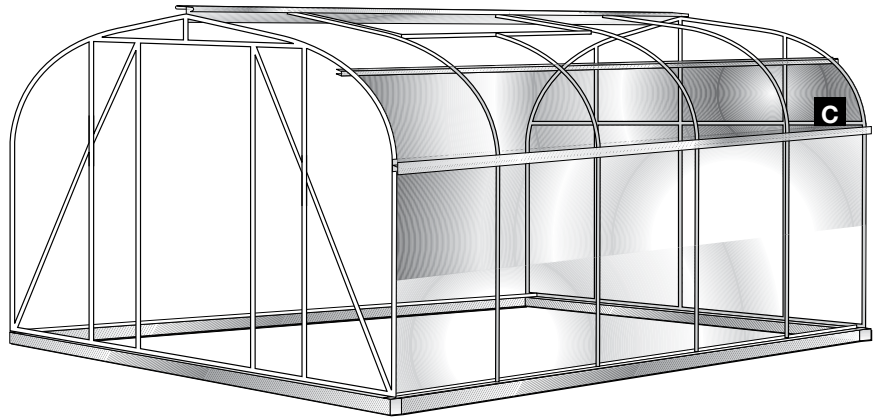

D. The next row of glass (*see the sketch for size*) overlaps the curved glass by 1/2". Therefore, the cap is 1/2" shorter than the glass **7**.

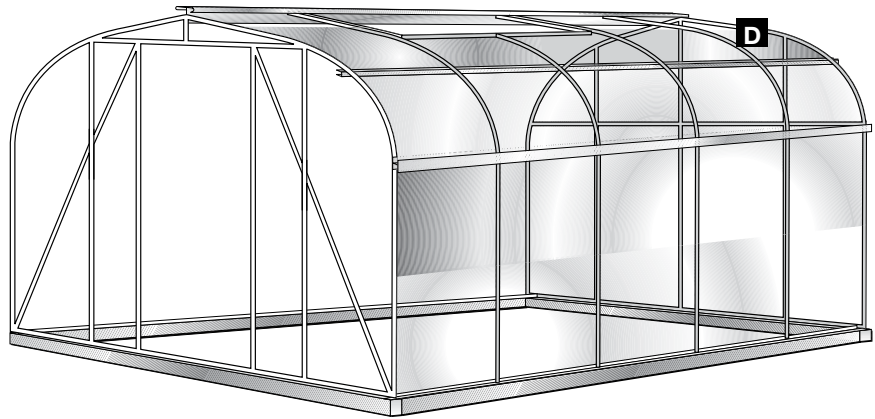

Cut a 6" piece of foam strip and lay it on top of the existing foam, starting with one end against the edge

of the curved glass. This will eliminate any air drafts due to the overlap of the glass **8** & **8A**. Lay the next glass against the curved aluminum cap (*giving you a 1/2" overlap*). The aluminum cap for this row has a slight bend in it. This bend makes it easier to fasten it to the curved shape of the greenhouse. Again, the bottom hole of the aluminum cap should line up with the top hole of the curved cap. The size of the glass is on your glazing sketch. When you do this row of glass, the glass below the vents may be a different size.

NOTE: Every row of glass in the roof is done the same way. The glass always butts against the aluminum cap and the aluminum cap top hole lines up with the next cap's bottom hole **9**.

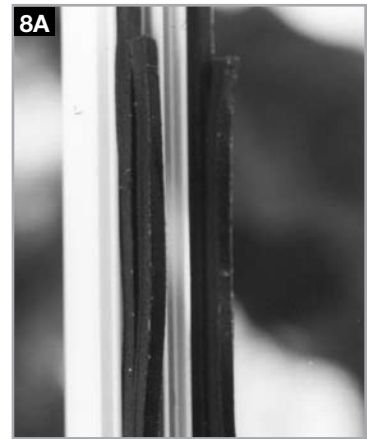

- E. Install the last row of glass. The top edge of the glass slips under the ridge flange. After one side of the greenhouse is completed, go to the other side and start again.

14. ENDS

BACK: The first row of glass is the same height as the side glass. The corner glass slides behind the end bar flange (No cap is required) **10**. Put on the plastic "H" and install the next rows (See the glass sketch for size).

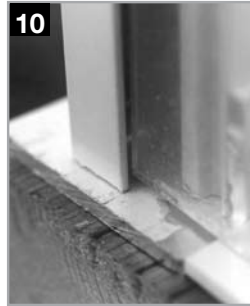

FRONT: Glazing is exactly the same for the front as it is for the back except that the front has the door. The glass beside the door fits into the first slot in the doorframe (See the glass sketch).

15. SEALING THE GREENHOUSE (after all the glass is installed)

Caulking is used for sealing aluminum to the wood/concrete base (see picture on page 12).

For most people, silicone is easier to use for sealing glass to aluminum. The areas that need to be sealed with silicone include:

- On the front and the back of the endbars **12**
- Around the ventframe **13**
- Below the gutter
- Along the ridge where the glass slides under the flange
- Around the doorframe **14**
- Doorframe beside the base / sill **15**



NOTE: Do not seal the glass to the base as the water needs to drain out.



Door Installation

(Refer to the drawing.) Take the door and set it inside the doorframe. Lift it up as high as possible on the hinge side and put the screws through the existing holes in the doorframe. Now the door will hang by itself.

Remove the plastic clip from the "Z" bar and put one screw into the doorframe to hold the "Z" bar. Open the door, take off the clips and put back the screws. Close the door and check that it is square. If the frame and the door are square, then fasten the "Z" bar to the frame. If not, move the "Z" bar up or down to square it. If this is not enough, loosen the bolts in the top plates and move the frame to make it square. When it is in place, tighten all the bolts.

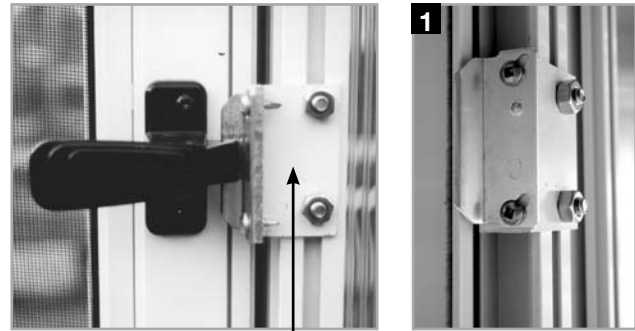

Door Catch Angle

Next install the door handle (see the instructions inside the box). To install the door catch angle, slide in two bolts into the back of the door frame. Bolt on a small angle (provided with the door handle). Face the angle towards the door, line it up with the center of the door handle, and then tighten the two bolts (see picture to the right). Take the door catch out of the door handle box and screw it on. Close the door and adjust the door sweep at the bottom of the door to eliminate potential gaps.

NOTE: There are two types of manufactured doors. The door catch angle on the white door may have to be turned the opposite way as shown on picture **1**.

Run a bead of silicone under the angle above the door and against the doorframe. Also silicone the "h" on the glass beside the door to ensure an airtight seal.



Door Installation

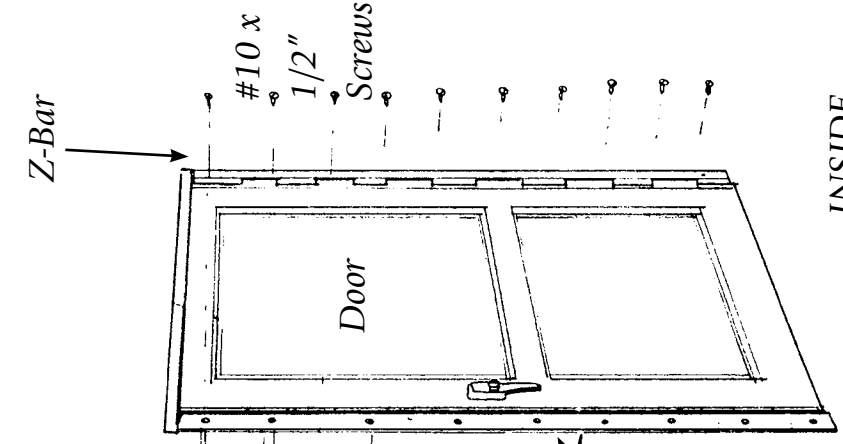
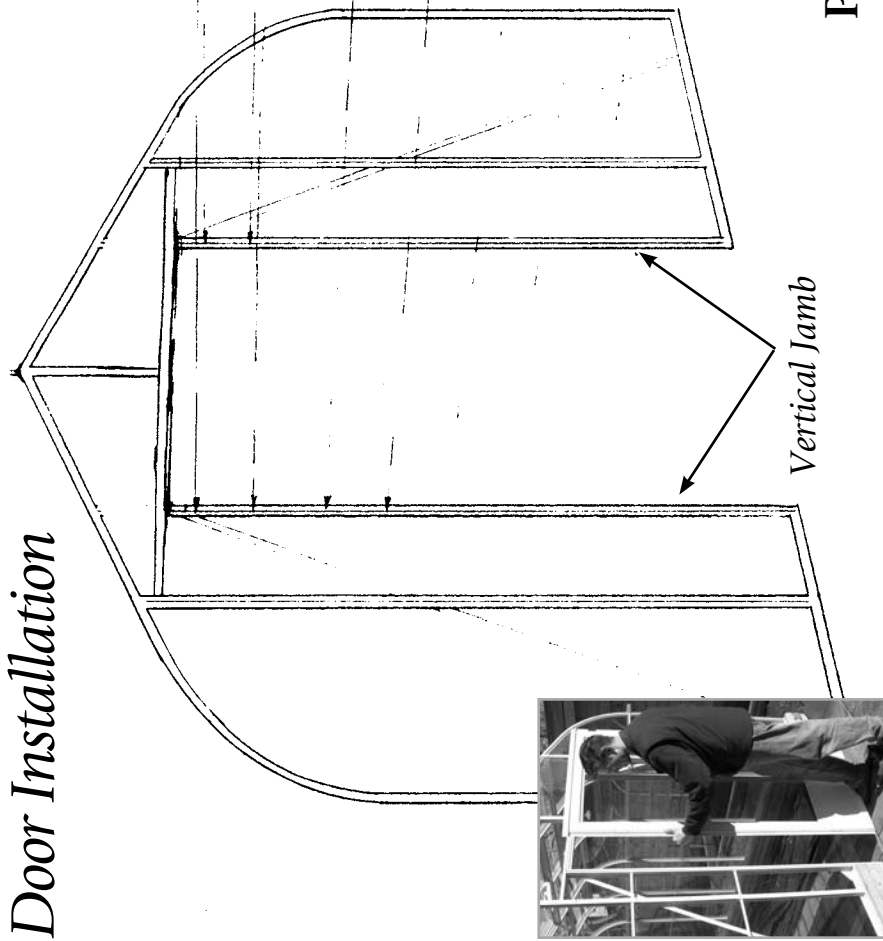

Plan View

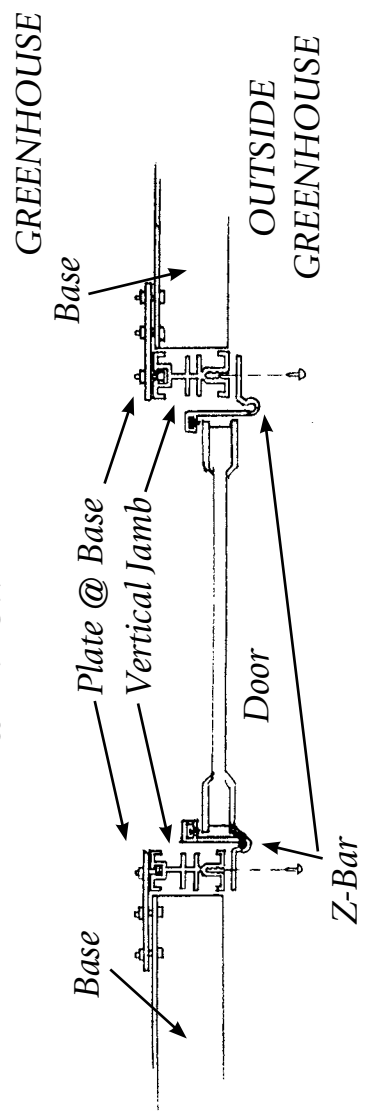

Vent Assembly

(See Drawing on Page 30)

1. Lay down the vent gutter with the punches facing up towards you.
2. Glass Bars with sliders are for the end. Lay them down with the bolt slot facing up.
3. Lay the vent hinge with the punches facing up towards you.
4. Slide the bolts into both ends of the end bar. Take the gutter and line up the bolt with the first punch, slide the bolt down and tighten it. Do the same with the hinge, the other side and center bar. Make sure that the Glass Bars fit tightly into the gutter and hinge after the vent is assembled.
5. Turn it over and square it up.
6. Put the 1/8" foam on the Glass Bars.
7. Take the glass and slide it up into the hinge track. Drop it down on the gutter. Do the same with the next piece of glass.
8. Take the caps and lay them on the bars, center them and screw them on with a 3/4" screw.
9. Take the silicone gun and seal where the glass slides into the hinge.
10. 3/4" screw through hinge & gutter into glass bars.



VENT INSTALLATION

Take the vent and slide it into the end of the ridge (See Picture **A**).

After you remove the screw in the ridge, push it into place and put the screw back in (See Picture **B**). Now attach the automatic opener.

Vent Opener

INSTALLING THE BAYLISS AUTOMATIC VENT OPENERS

Detailed instructions are included in the box with the control (there are a few extra parts).

Use #10 stainless steel screws to fasten the Bayliss and the vent sill ① and the vent ②. All holes are already drilled. After the Bayliss is fastened in place, install the threaded adjuster into the swivel block. This is made easier by lifting the vent with one hand until the piston rod only projects 1/2" through the swivel block.

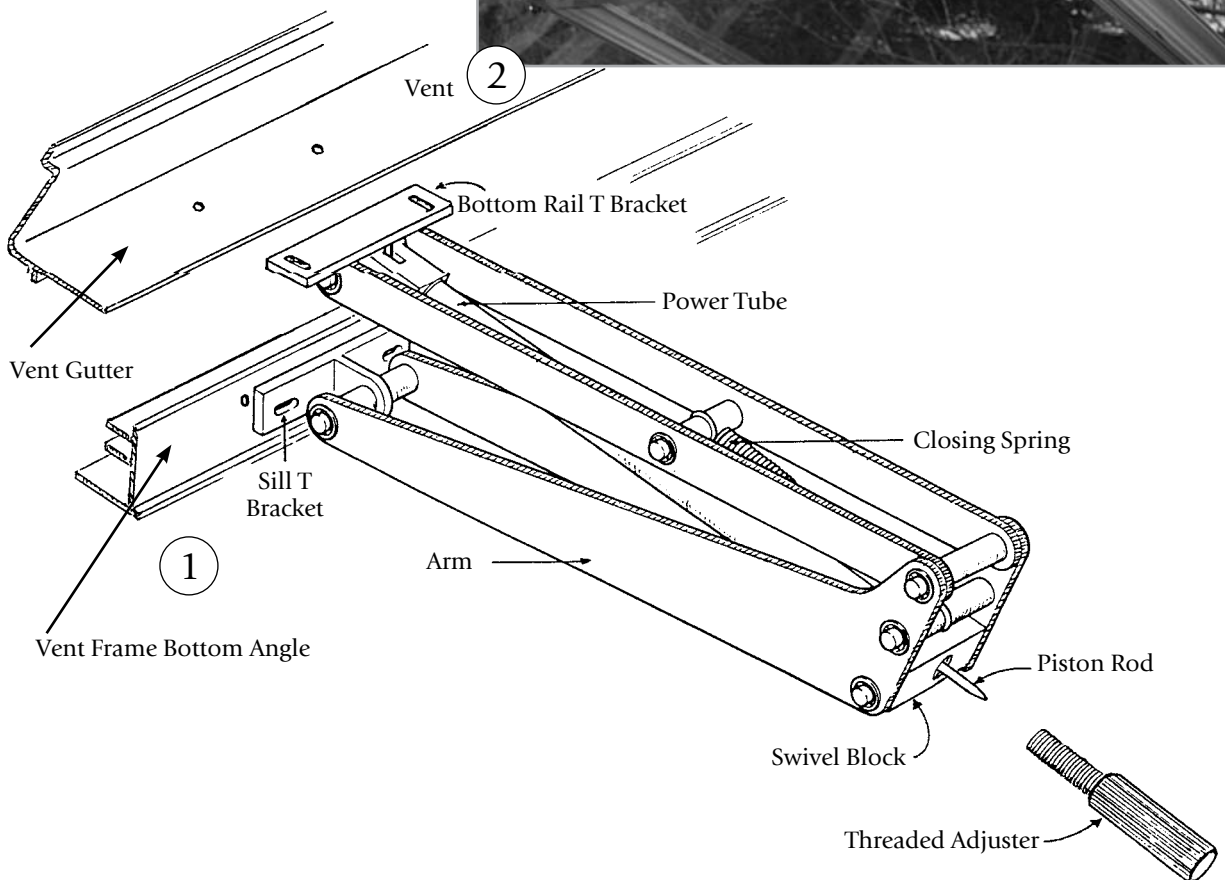

Glass Greenhouse Roof Vent Details

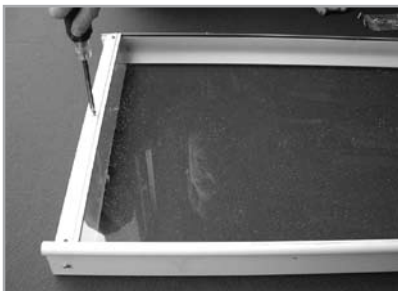
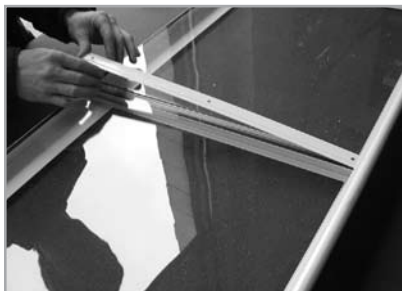
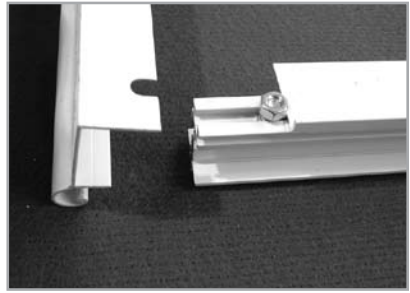
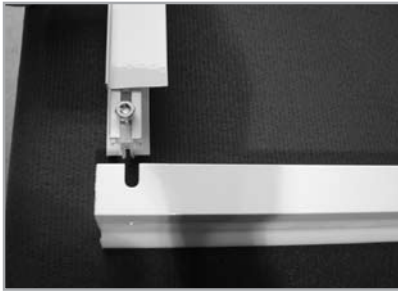
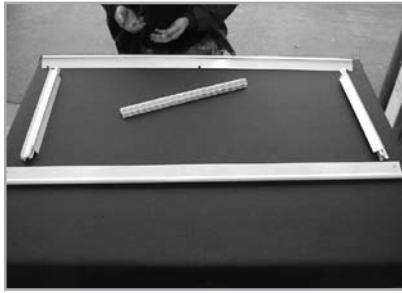

Vent Assembly - Exploded View

- ALL BOLTS SHOWN ARE $\frac{3}{8}$ " LONG
- ALL FACE CAP SCREWS ARE $\frac{1}{4}$ " LONG
- GUTTER END SCREWS ARE $\frac{3}{4}$ " LONG
- VENT HINGE END SCREWS ARE 1" LONG

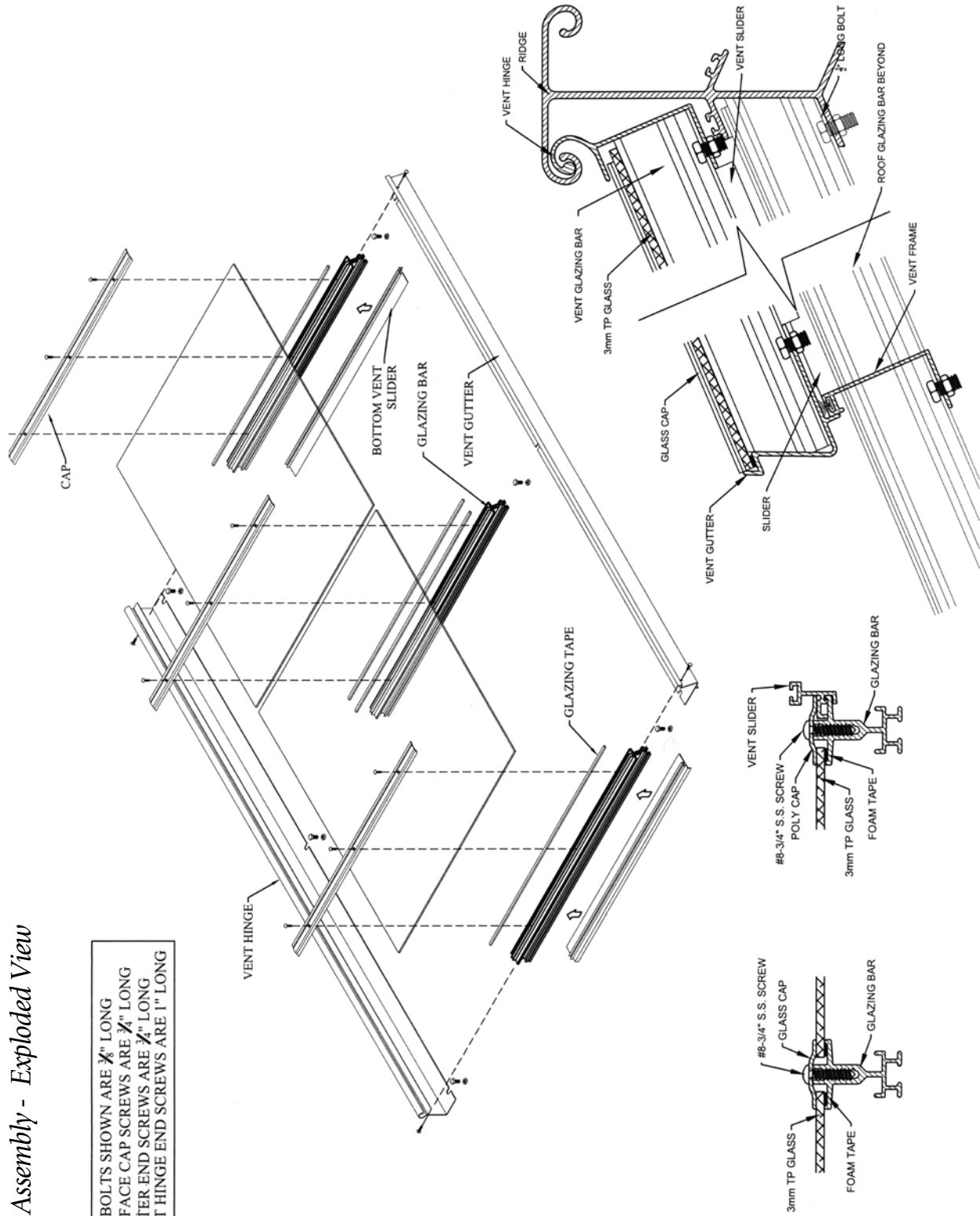

Appendix A – Truss

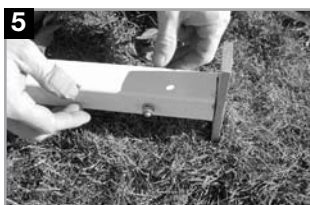

1. TRUSS ASSEMBLY

(This section is to be used only for greenhouses that are over 14' long.)

Trusses are usually installed after the sides, base, front, back and ridge are bolted together. Make sure that the greenhouse is temporarily braced (*see 4A on Aluminum Frame Assembly*).

- A. Lay the truss piece in the shape of an end wall.
- B. Slide the center pieces into the top of the truss and bolt them together. **1**, **2** & **3** (*lean to models do not have a center piece – see next page*).
- C. Slide the truss feet into the bottom of the truss and bolt them together **4** and **5**.
- D. Bolt on the cross brace (*if required*) **6**.

2. TRUSS ASSEMBLY & INSTALLATION (IF REQUIRED)

The next step takes two people, one on each side. Carry the truss to the center of the greenhouse and put the feet on your foundation between the side base/sill **7**. Lift the top of the truss towards the ridge and bolt it on **8**. Use the notch on either side of the center. (*For lean to installations line up the top of the truss 1⁵/₁₆" off-centre of roof glazing bar and temporarily fasten with a screw to the wall. This should be permanently lagged to the wall after greenhouse is square and the purlin has no sags at the truss. The gap between the underside of the bar and top of the truss should be 3."*)

Remove the truss bracket from the truss. (*It may also be in a plastic bag.*) Unbolt the bar from the base. Slide the truss bracket into the bottom of the glass bar (*long bar*) **9** & **10** and slide it to the place where there is a 9/64" hole drilled into the truss. Fasten it with a screw. If the hole does not line up, you may have to drill a new hole in the truss bracket **11**. Do this after all the glass bars have been bolted together. To fasten the truss to the foundation, use 1/4" x 2" leg bolts.



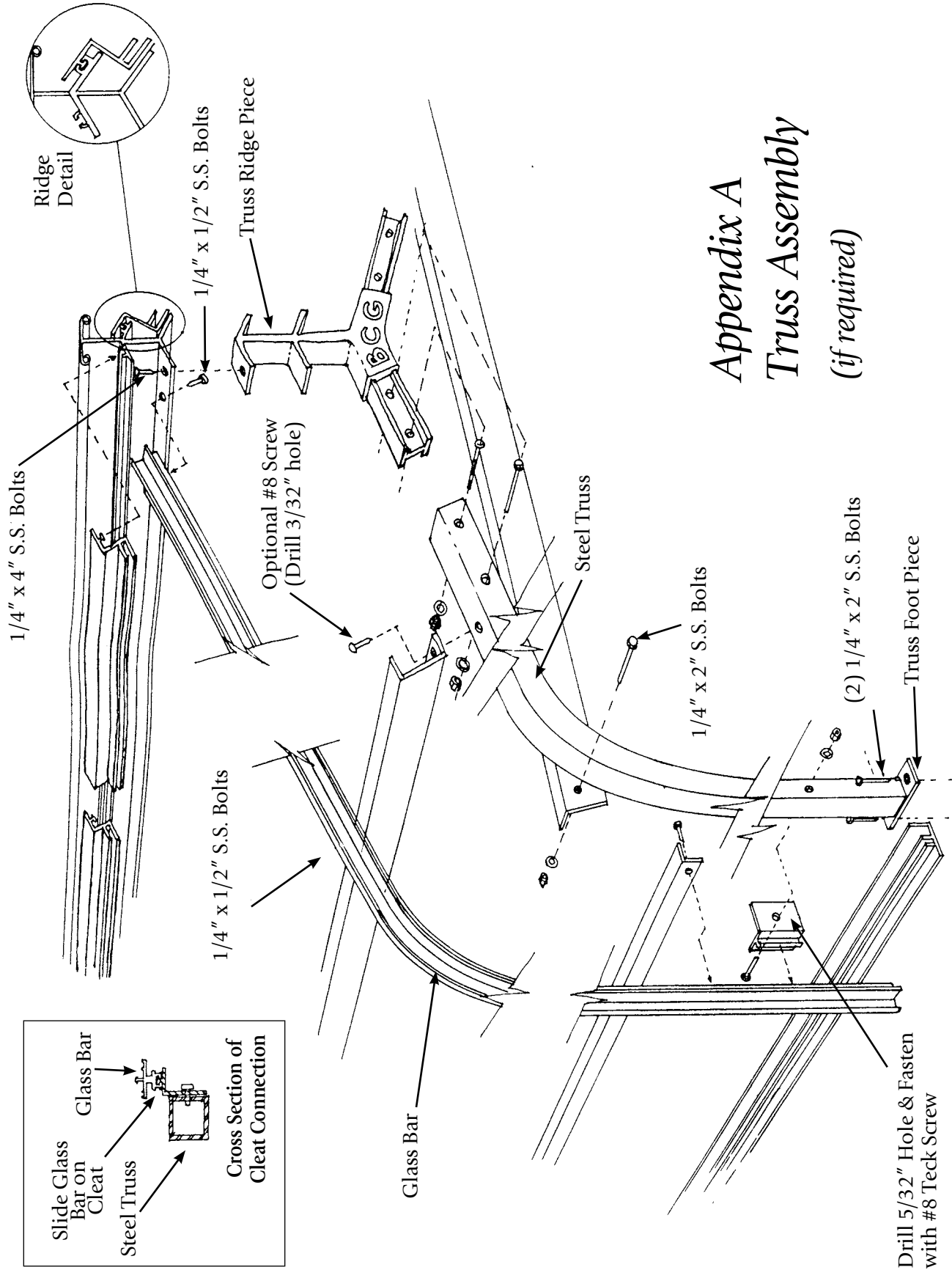

Appendix A Truss Assembly (if required)

Appendix B – Motorized Intake Shutter

NOTE: Installation of the intake shutter is the same for a glass or polycarbonate greenhouse

- Slide bolts in through notches provided (*a small piece of foam stuffed in track under bolt keeps it from sliding down*).
- Ensure the blades open with flaps facing down.
- Install glass or polycarbonate on frame of intake shutter.
- Seal around the intake shutter after glass or polycarbonate is installed.

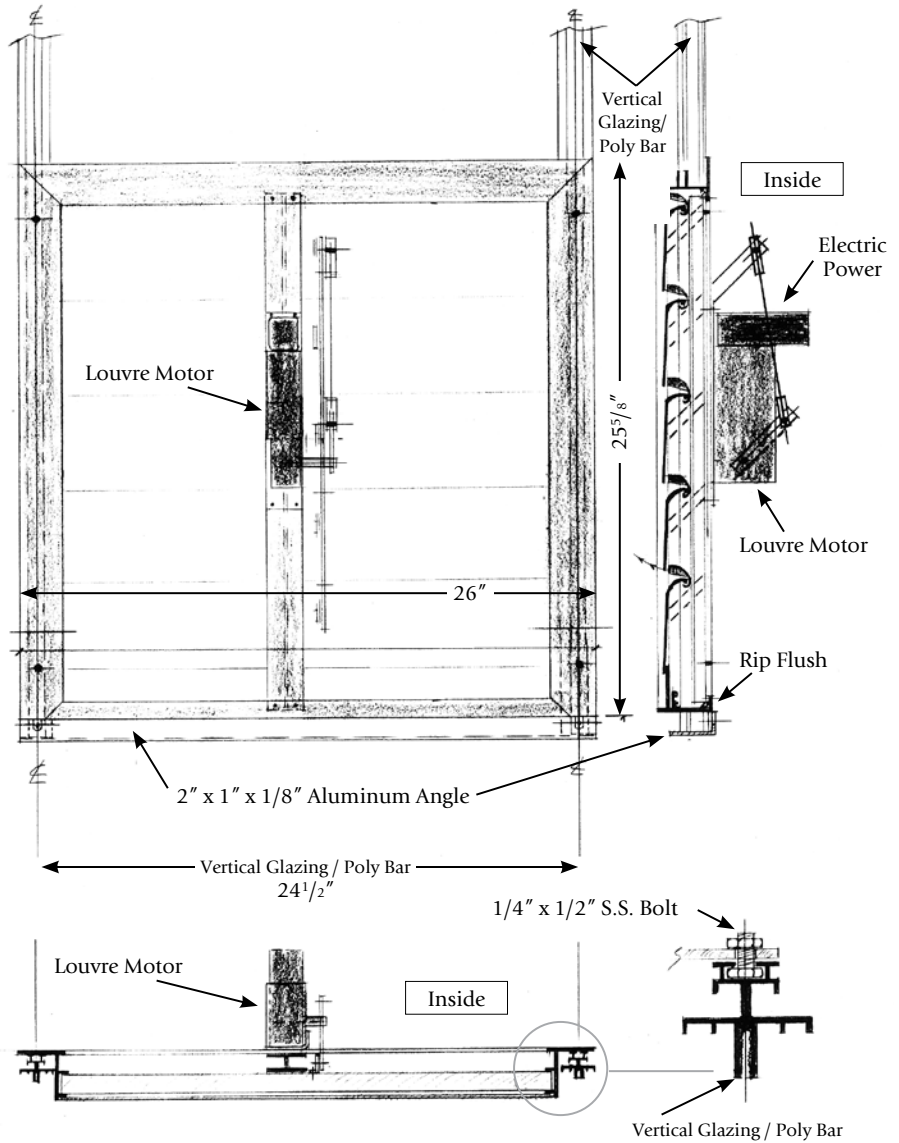

Inside View



Appendix C – Exhaust Fans

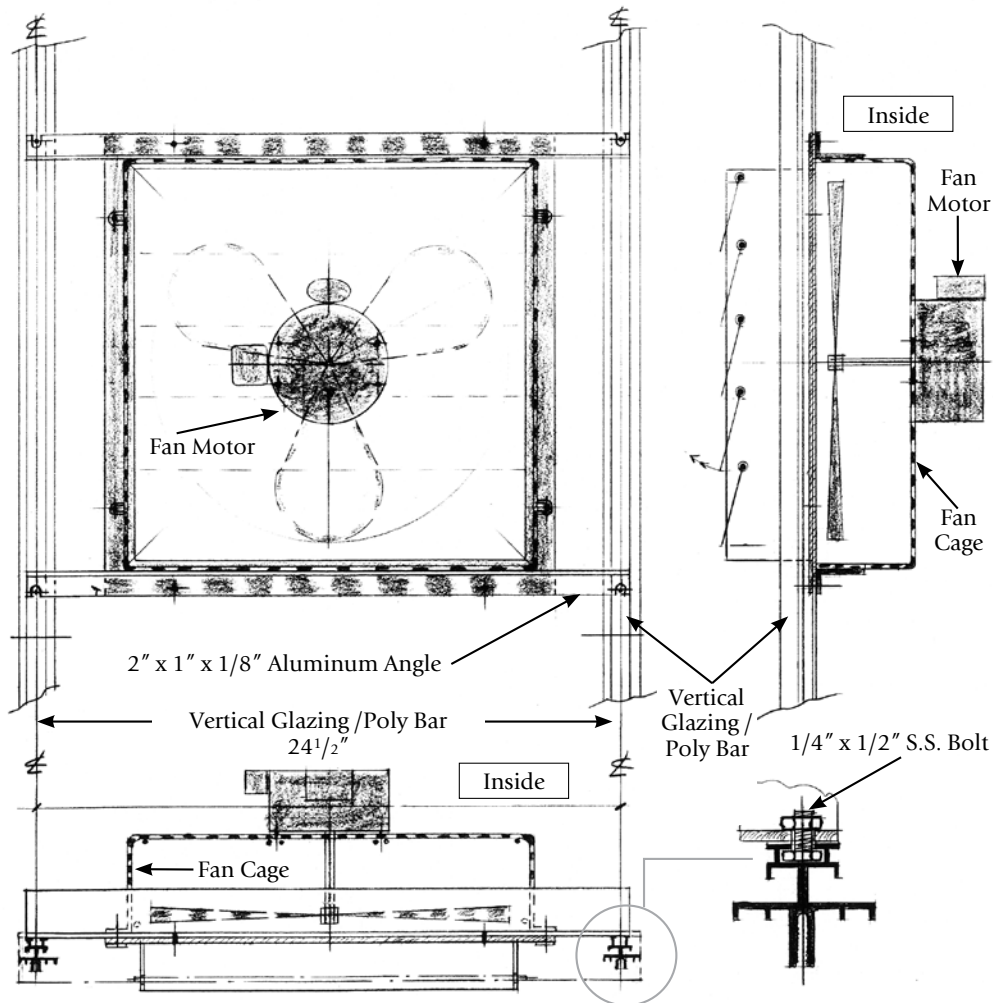

- Slide bolts into vertical bars beside fan bottom.
- Temporarily tighten.
- Insert fan in square cutout of acrylic piece.
- Slide bolts into slots on angle and tighten
- Seal around shutter on outside.



Appendix D – Glass Louvre

GLASS OR POLYCARBONATE GLASS LOUVRE ASSEMBLY



Appendix E – Side Vent

GLASS OR POLYCARBONATE SIDE VENT ASSEMBLY

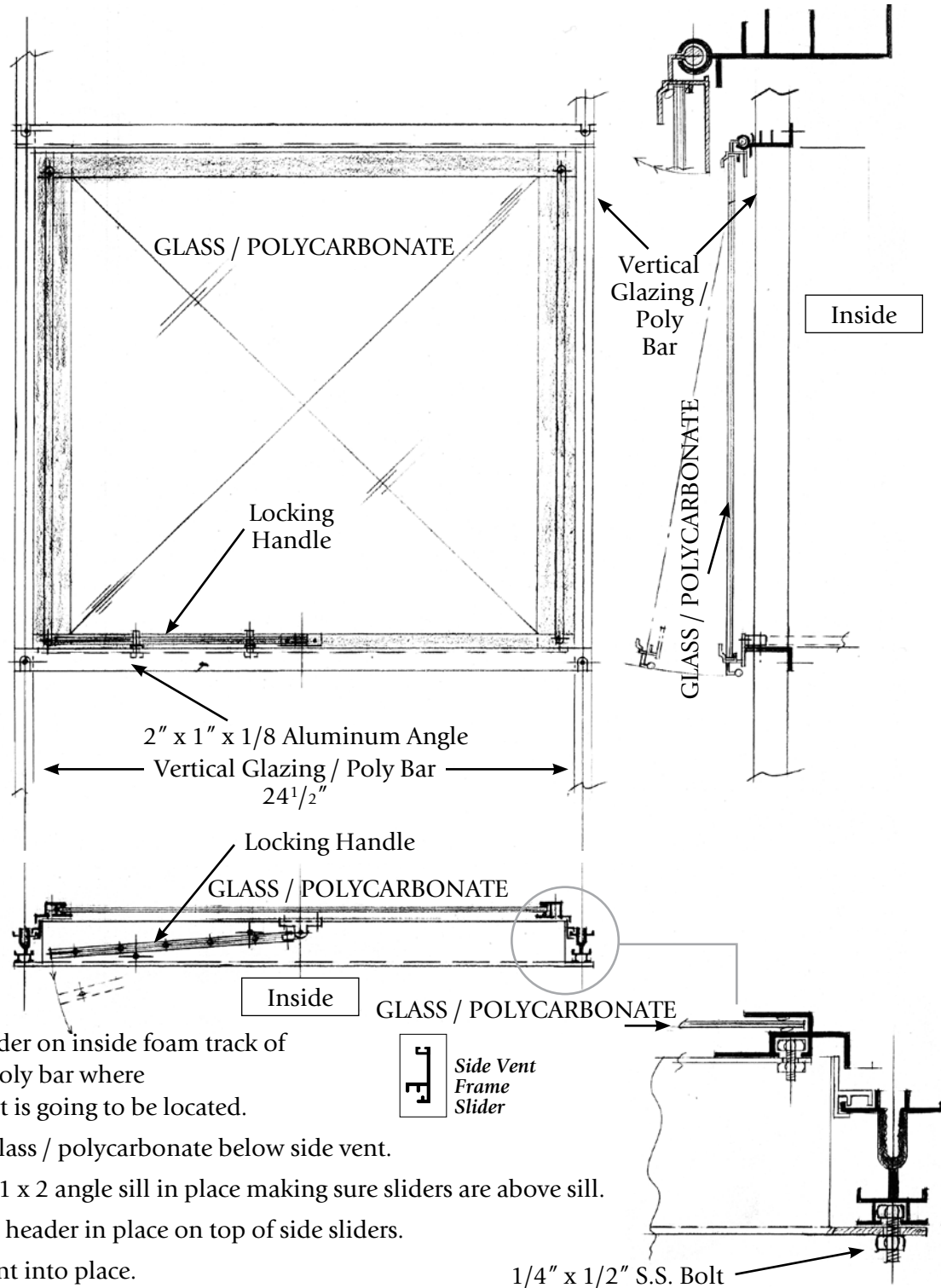

1. Slide slider on inside foam track of glass / poly bar where side vent is going to be located.
2. Install glass / polycarbonate below side vent.
3. Bolt on 1 x 2 angle sill in place making sure sliders are above sill.
4. Bolt top header in place on top of side sliders.
5. Slide vent into place.
6. Install automatic or manual opener.

Appendix E – Side Vent CONTINUED

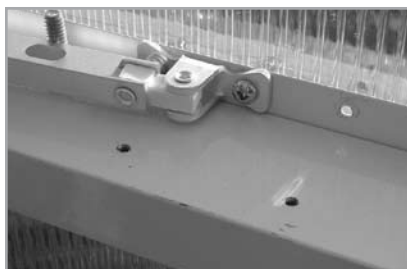
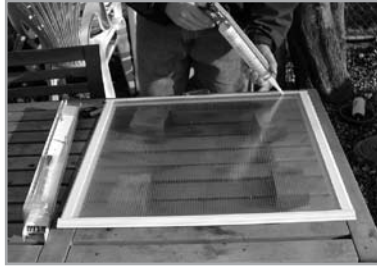
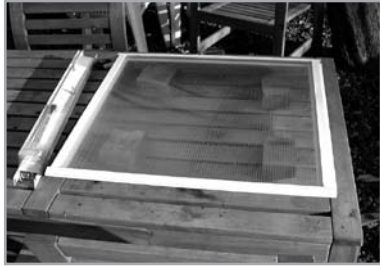

Appendix F – Diagonal Brace

Diagonal Braces are used for larger greenhouses – 16' and up.

INSTALLATION

1. Unwrap the brace, loosen up the bolts on the ends and turn the angles. **#1**
2. Take the end of the brace with the straight angle and bolt it to the end wall. **#2**
3. The other end is fastened to the ridge. You can use a self-drilling screw (supplied) or pre-drill the hole using 9/16" drill bit. **#3**

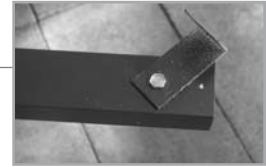

Appendix G – Purlin Installation

Larger greenhouses have purlins to increase strength in roof structures. A purlin can be a heavy or light channel. It usually sits on top of a truss and is bolted to the roofbars in the centre of the roof.

Heavy purlin (*at least 1/4" thick*) requires 1/4" x 3/4" bolts. Smaller greenhouses use a light channel – bolts used are the same as the greenhouse bolts, 1/4" x 1/2."

Installation of a purlin is a simple matter of sliding the bolts into the roof bars and fastening the purlin (*see photos*).

Bolt Purlin with the open side facing up if you wish to use it for hanging baskets.

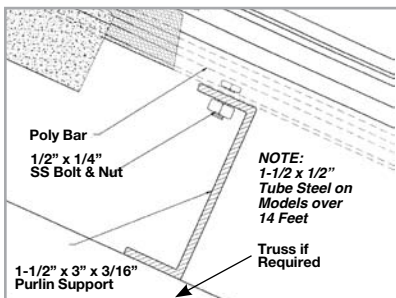
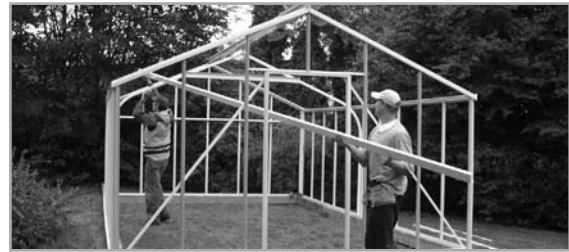
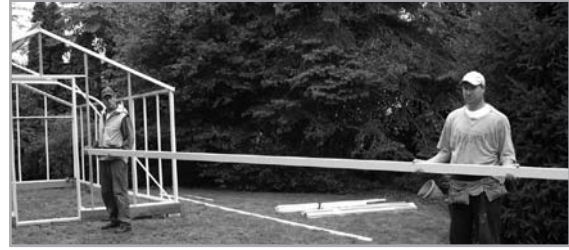

Appendix H – Greenhouse Bench

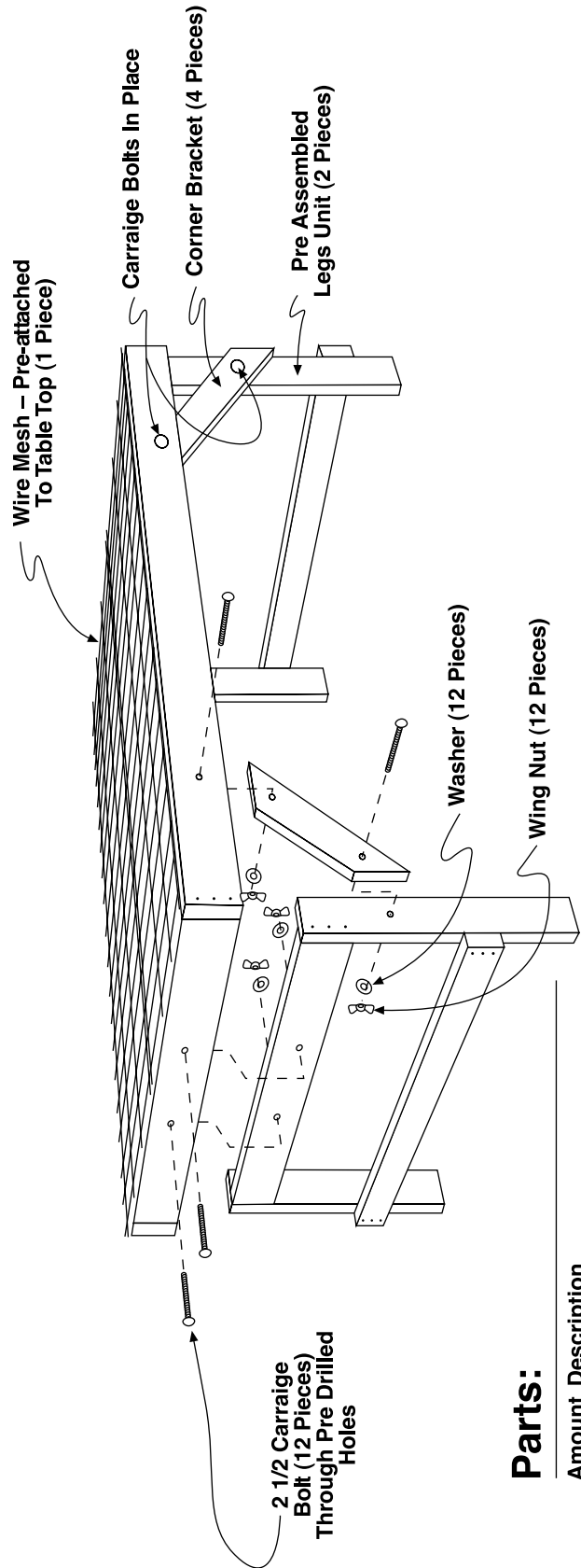

Parts:

Amount	Description
1	Table Top = W/ Pre-attached Wire Mesh Plastic Coated W/Guide Holes
2	Leg Units = Pre-assembled W/ Guide Holes
4	Corner Brackets = W/ Guide Holes
1 Bag	Contains: 12 - 2 1/2 Carrage Bolts 12 - Washers 12 - Wing Nuts

Appendix I – Side Vent Screen

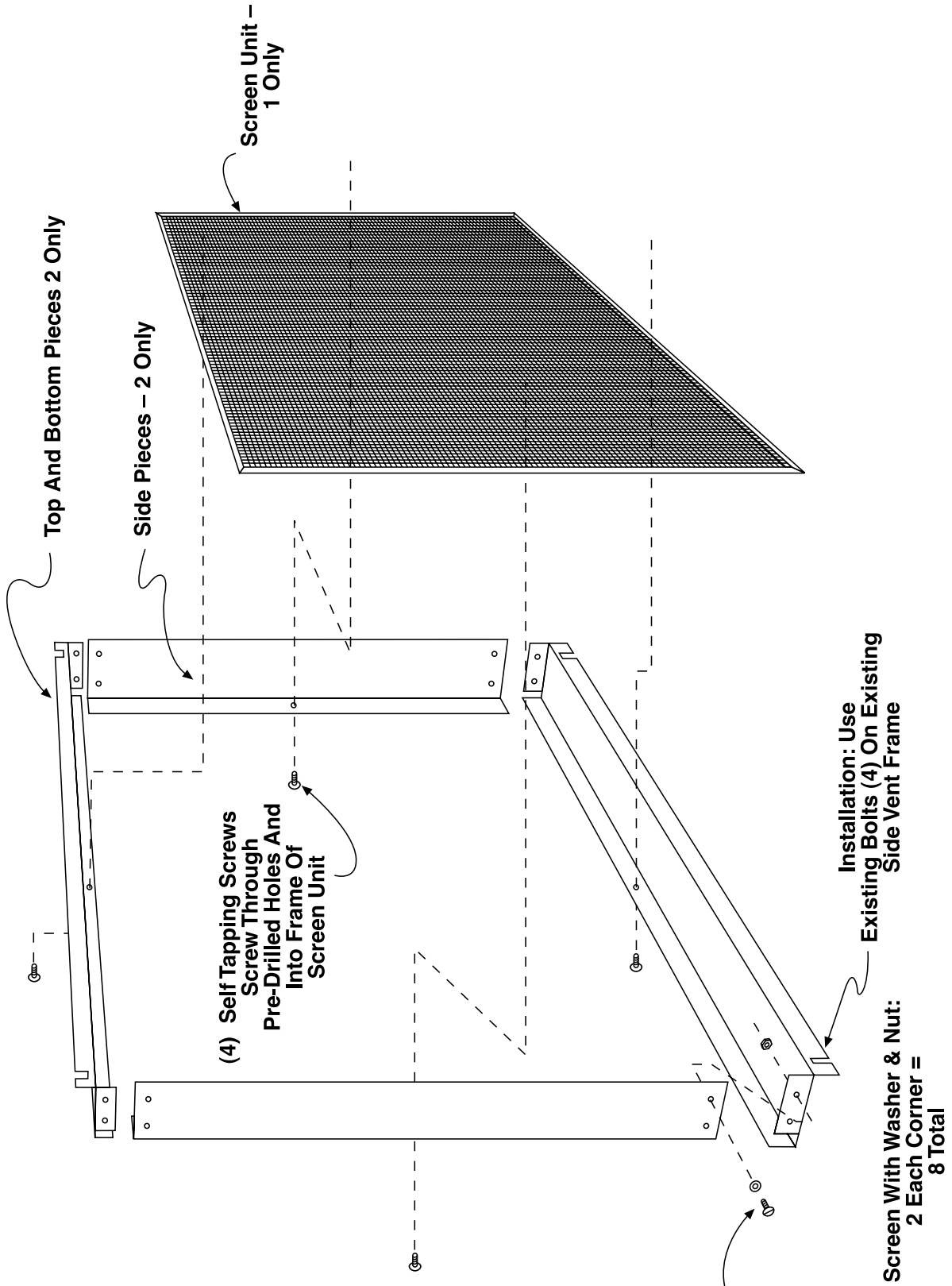

Appendix J – Roof Vent Screen

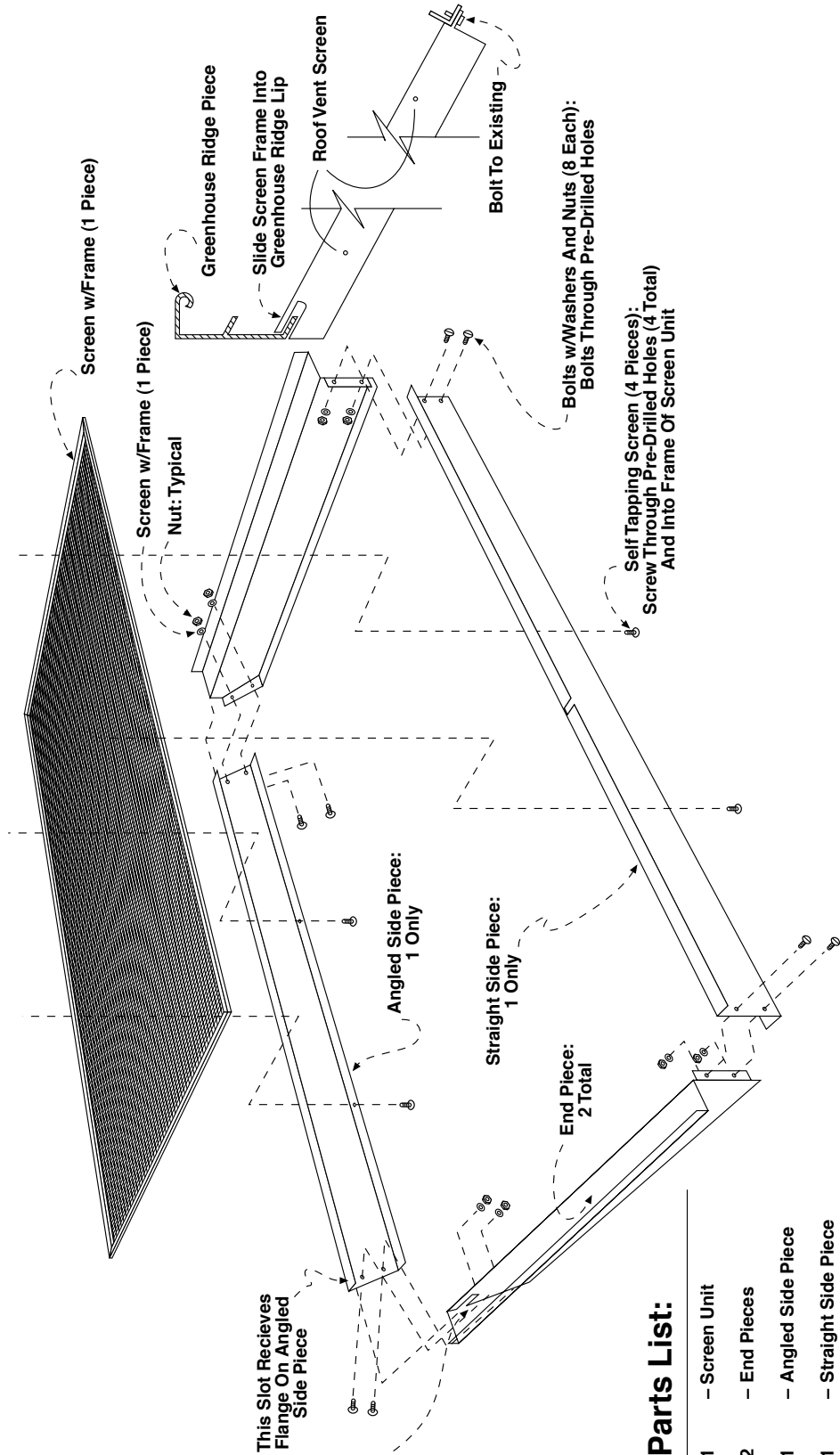

Appendix K – Wire Shelving

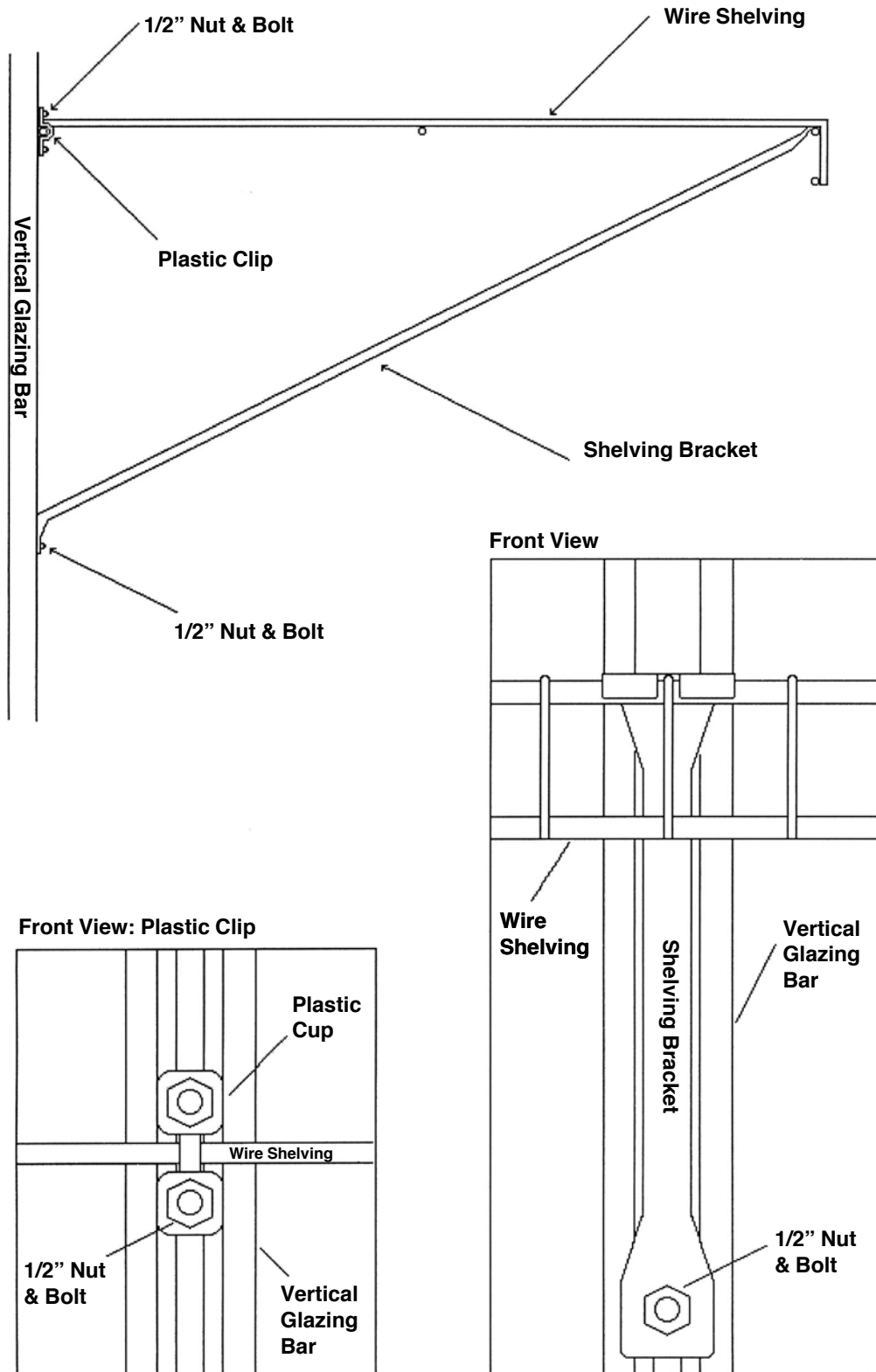

Miscellaneous Assembly Details – 1

VENT FRAME 3D VIEW

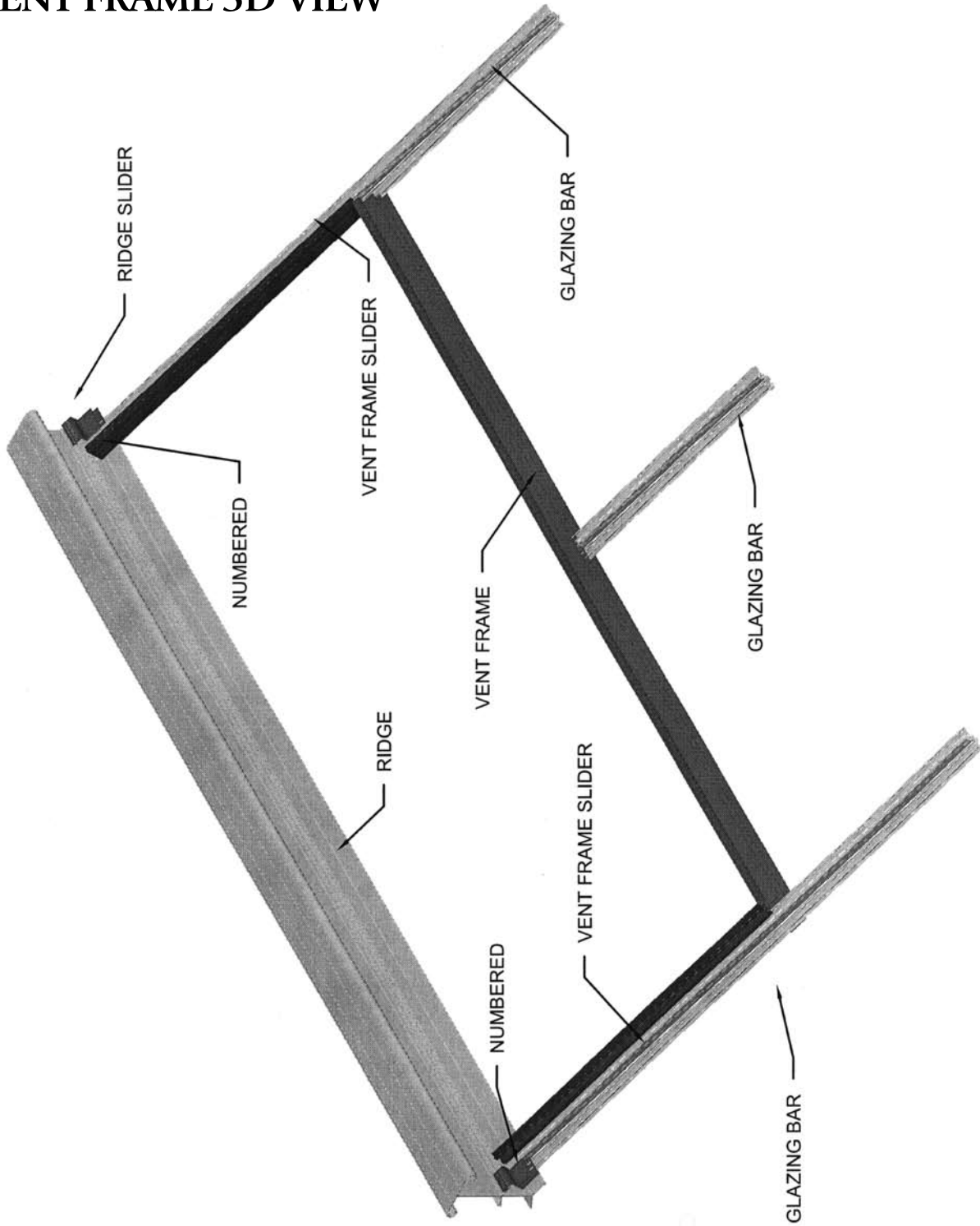

Miscellaneous Assembly Details – 2

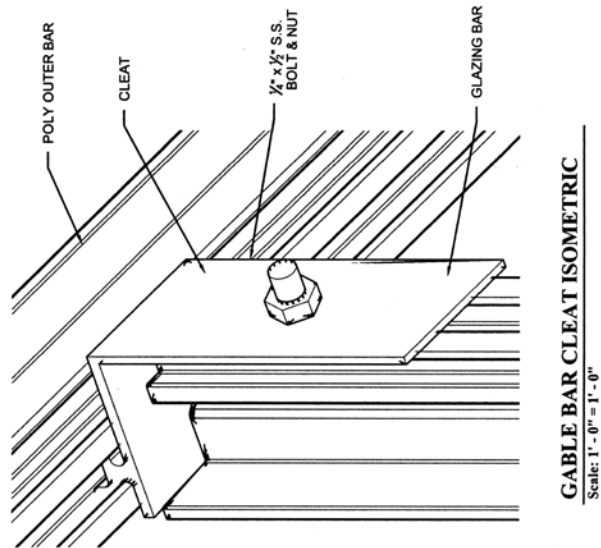
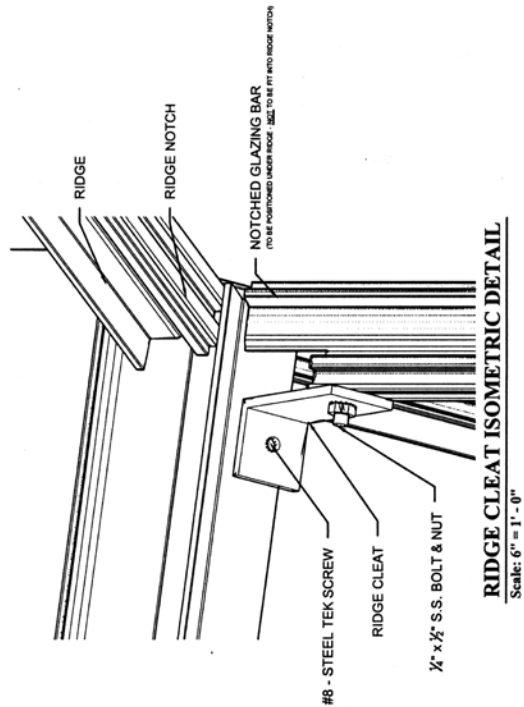
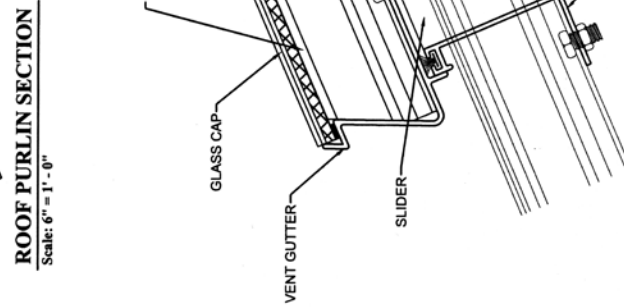
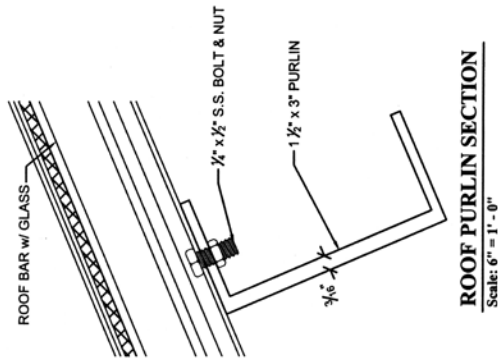
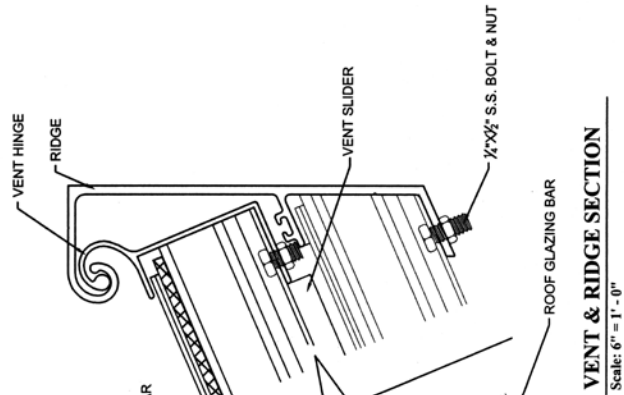
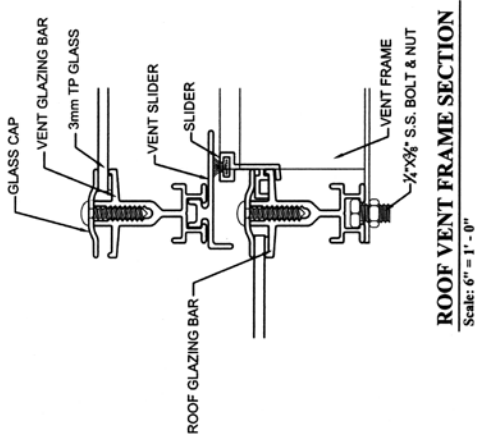

Miscellaneous Assembly Details – 3

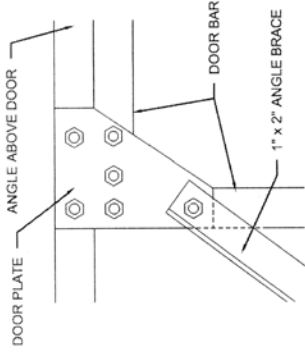

ANGLED DOOR BRACE
Scale: 3\"/>

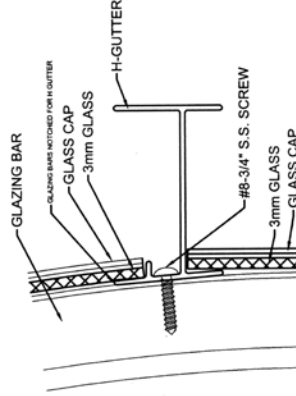

H-GUTTER DETAIL
Scale: 6\"/>

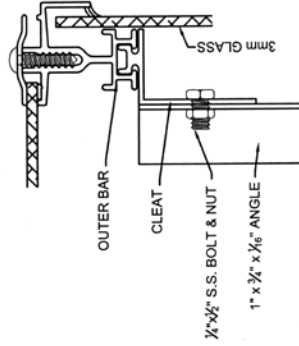

CORNER CLEAT DETAIL
Scale: 6\"/>

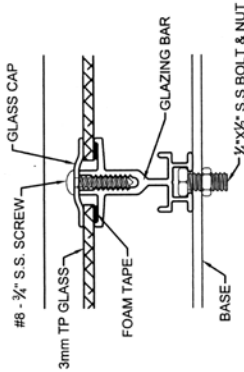

GLAZING BAR
Scale: 6\"/>

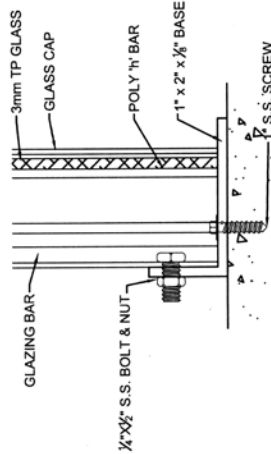

GABLE BASE SECTION
Scale: 6\"/>

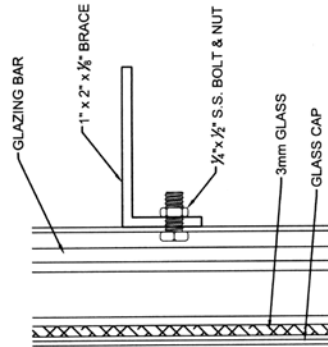

HORIZONTAL BRACE SECTION
Scale: 6\"/>

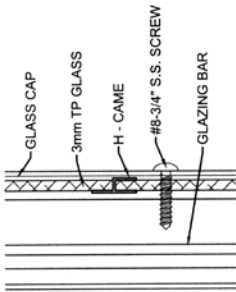

H-CAME SECTION
Scale: 6\"/>

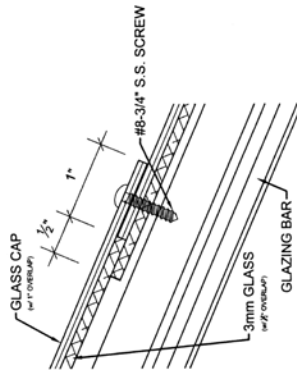

GLASS OVERLAP DETAIL
Scale: 6\"/>

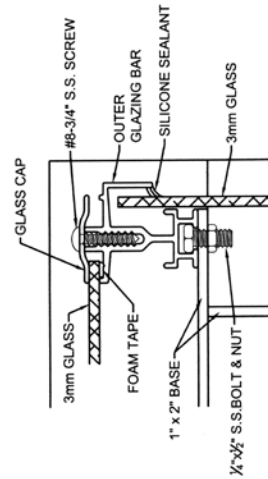

CORNER DETAIL
Scale: 6\"/>



At this point, stand back and enjoy your workmanship.

*Your Pride of the Pacific Greenhouse
should now be closed in and ready for use.*

Congratulations!