

# *Pride of the Pacific Series* Curved Glass Lean To Model PLT612SG

---

## GREENHOUSE INSTRUCTIONS

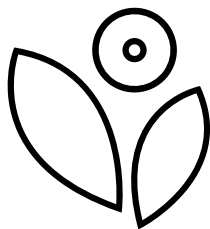

Greenhouse Style  
CORPORATION

Telephone: 1-800-665-2124 | Fax: 1-888-273-1251

[www.greenhousetyle.com](http://www.greenhousetyle.com) • [info@greenhousetyle.com](mailto:info@greenhousetyle.com)

# Contents

Foreword . . . . .	2
User Notes . . . . .	2
List of Drawings . . . . .	3
Pride of the Pacific Component List . . . . .	4
Foundations . . . . .	5
<b>Assembly Of The Aluminum Frame</b>	
A. Back Gable End Assembly . . . . .	7
B. Front Gable End Assembly With Door . . . . .	9
C. Taping Glass Bars With Foam . . . . .	12
<b>Aluminum Frame Installation</b>	
1. Side Base/Sill . . . . .	13
2. Front Gable End . . . . .	13
3. Back Gable End . . . . .	13
4. Ridge . . . . .	13
4A. Truss Assembly Installation (if necessary) . . . . .	See Appendix A
5. Glass bars With Sliders (#1 or #2) . . . . .	13
6. Ventframe Angle . . . . .	14
7. Glass bars . . . . .	14
8. Gutter . . . . .	14
9. Roof Purlin (Channel) . . . . .	14
10. Center Bars . . . . .	14
11. Tape All Glass bars . . . . .	14
11A. Side Vents, Intake Shutter and Exhaust Fan Installation (if necessary) . . . . .	See Appendix B - E
<b>Glass And Cap Installation</b>	
General Information . . . . .	22
12. Glazing . . . . .	22
13A-E. Side Walls . . . . .	22 - 26
14. Ends . . . . .	26
15. Sealing The Greenhouse . . . . .	26
<b>Door And Vent Installation</b>	
16. Door Installation . . . . .	27
17. Vent Assembly . . . . .	29
18. Vent Installation . . . . .	29
<b>Appendices: Optional Installations</b>	
Truss Installation . . . . .	Appendix A
Vent Opener . . . . .	Appendix B
Exhaust Fan . . . . .	Appendix C
Side Vent . . . . .	Appendix D
Glass Louvre . . . . .	Appendix E
Perlin Installation . . . . .	Appendix F
Greenhouse Bench . . . . .	Appendix G
Roof Vent Screen . . . . .	Appendix H
Side Vent Screen . . . . .	Appendix I
Wire Shelving . . . . .	Appendix J
Miscellaneous Assembly Details: 1-3	

# Foreword

Your Pride of the Pacific greenhouse is designed and constructed to the highest engineering standards and provides structural strength and maintenance-free service for year-round gardening pleasure.

The Pride of the Pacific greenhouse must be built upon a firm, level surface. The greenhouse foundation or sill can be made from pre-treated timbers, concrete or bricks. Whatever your choice of material, the base must be square and level.

When selecting a site for your greenhouse, keep in mind that a flat, level site is essential so that the greenhouse can be easily installed and the complete structure is stable and secure. If possible, choose a site with proper water drainage.

Locating the greenhouse in a north-south position is most suitable for raising summer and autumn crops since the sun's rays will be on the greenhouse from daybreak until sunset. An east-west position is ideal for early spring and winter crops since the winter months, with shorter daylight hours, still allow six hours of light exposure to the greenhouse.

Try to locate your greenhouse for easy access, especially to the necessary power and water that is required for greenhouse gardening.

Please watch the enclosed video and follow the steps in this manual for your greenhouse installation. *Remember, if all else fails, read the instructions.*

---

## User Notes

The Pride of the Pacific greenhouse structure has been designed to withstand extreme weather conditions such as high winds and accumulated snowfall. Hanging baskets and sidewall shelving can also be attached to its sturdy frame. The greenhouse design also makes it possible to add extra sections at a later date.

Once a year the greenhouse needs to be completely washed inside and out. You should do this task when your greenhouse contains the least number of plants, generally just before the garden plants are brought in for wintering over. A recommended cleaning solution is a mixture of hot water with a disinfectant such as Lysol or Pinesol. Any benches, shelving, plastic trays, pots and baskets should also be cleaned thoroughly. *Prevention is the best known method for controlling pests and diseases in the greenhouse.*

**PLEASE NOTE:** *The Illustrations found in this manual may not be specific to your greenhouse, however the detail of aluminum shapes are all consistent.*

*The user notes are a generic instruction for all Pride of the Pacific Series Greenhouses – assembly instructions are common, only the sizes number of pieces and sizes vary.*

# List of Drawings

Pride Of The Pacific Component List .....	4
Foundation Styles .....	5
Back Gable End Line Drawing Assembly Procedure .....	7
Back Gable End Detail Drawing – <i>Details 1 – 4</i> .....	8
Front Gable End (With Door) Line Drawing Assembly Procedure .....	10
Front Gable End (With Door) Detail Drawing – <i>Details 5 – 10</i> .....	11
Assembly Outline: Aluminum Frame Steps 1 – 10. ....	15 - 21
Glass Installation Steps 12 – 14 .....	22 - 26
Door Installation .....	28
Vent Assembly - Exploded View .....	30
Greenhouse Architectural Details .....	31-32
Truss Installation .....	Appendix A
Vent Opener .....	Appendix B
Exhaust Fan .....	Appendix C
Side Vent .....	Appendix D
Glass Louvre .....	Appendix E
Perlin Installation .....	Appendix F
Greenhouse Bench .....	Appendix G
Roof Vent Screen .....	Appendix H
Side Vent Screen .....	Appendix I
Wire Shelving .....	Appendix J

# Pride of the Pacific Component List

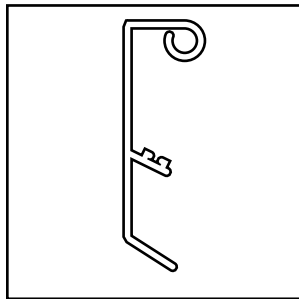

1/2 Ridge

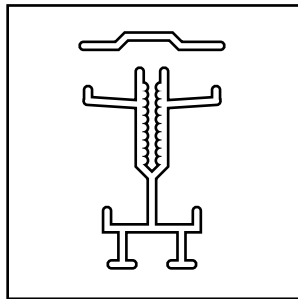

Glass Cap & Glass Bar

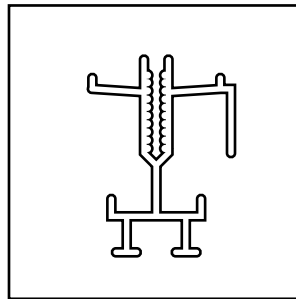

Glass End Bar

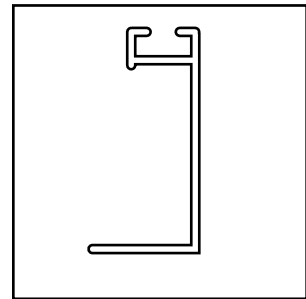

Ventframe Bottom

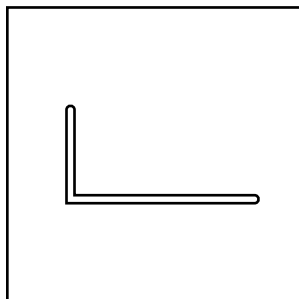

Bracing Angle

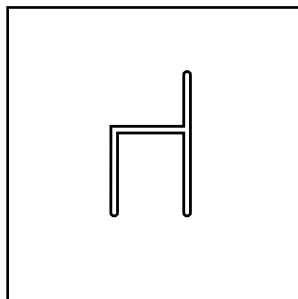

Plastic h came

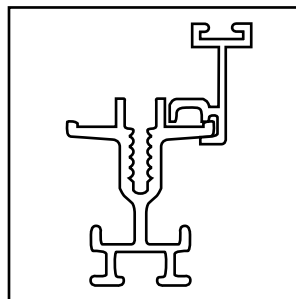

Vent Frame Sides

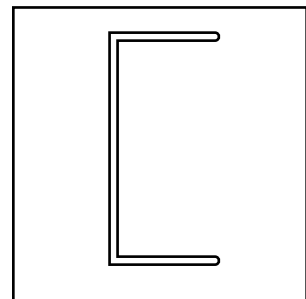

Purlin (if required)

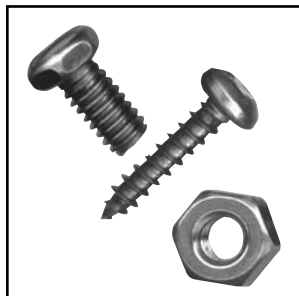

Screws and Bolts

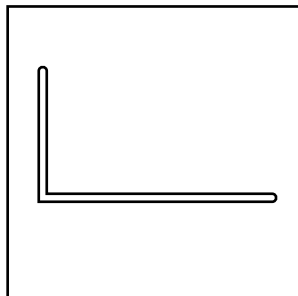

Base / Sill

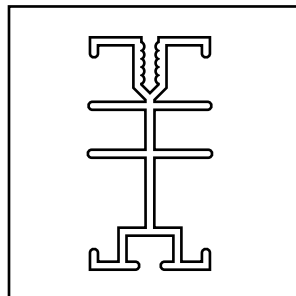

Door Frame

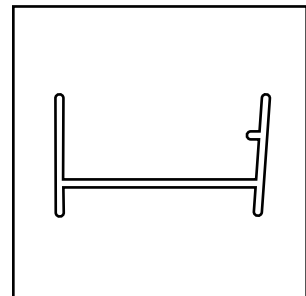

Gutter

## Tools

- #2 Square head screw driver
- Measuring tape
- Level to check foundation
- 3/16" concrete bit (concrete foundation)
- 9/64" aluminum bit
- 7/16" wrench
- Razor blade cutter
- Caulking gun
- Ladder
- Hammer

## Optionals

- Automatic Opener
- Circulating Fan
- Max/Min thermometer
- Benches
- Eyebolts
- Motorized Intake Shutter
- Exhaust Fan
- Thermostat
- Heater

# Foundations

Check your local building codes for foundation requirements in your area.

## CONCRETE FOUNDATIONS

When you prepare the concrete foundation, the size should be built to the exact greenhouse's outside dimensions.

## PRE-TREATED WOOD FOUNDATIONS

A greenhouse that is approximately 100 sq. ft. (9.3 m<sup>2</sup>) can be fastened to a 4" x 4" pre-treated wood timber foundation. For larger greenhouses, a 6" x 6" wood timber foundation is recommended. These timbers are placed on a 4" (10 cm) deep and 8" (20 cm) wide gravel bed. Wood timbers can be stacked to increase the height of the greenhouse. *One advantage of the wood foundation is that it is not classified as a permanent structure. Therefore, if you move, the greenhouse can be dismantled and moved to another location.*

## A SQUARE AND LEVEL FOUNDATION

Check the width and length of the foundation's outside dimensions. Then, square the foundation by measuring diagonally from opposite corners in the form of an "X". Next, use a long carpenter's level to check and adjust the foundation until it is level. Finally, measure where the door will be placed (in most cases it is 34<sup>1</sup>/<sub>2</sub>" wide). Mark these measurements on your foundation.

### Foundation Styles

**IMPORTANT NOTE:** If pressure treated timbers are used, a 10mm polyethylene barrier must be used between the wood and the aluminum (see page 6)

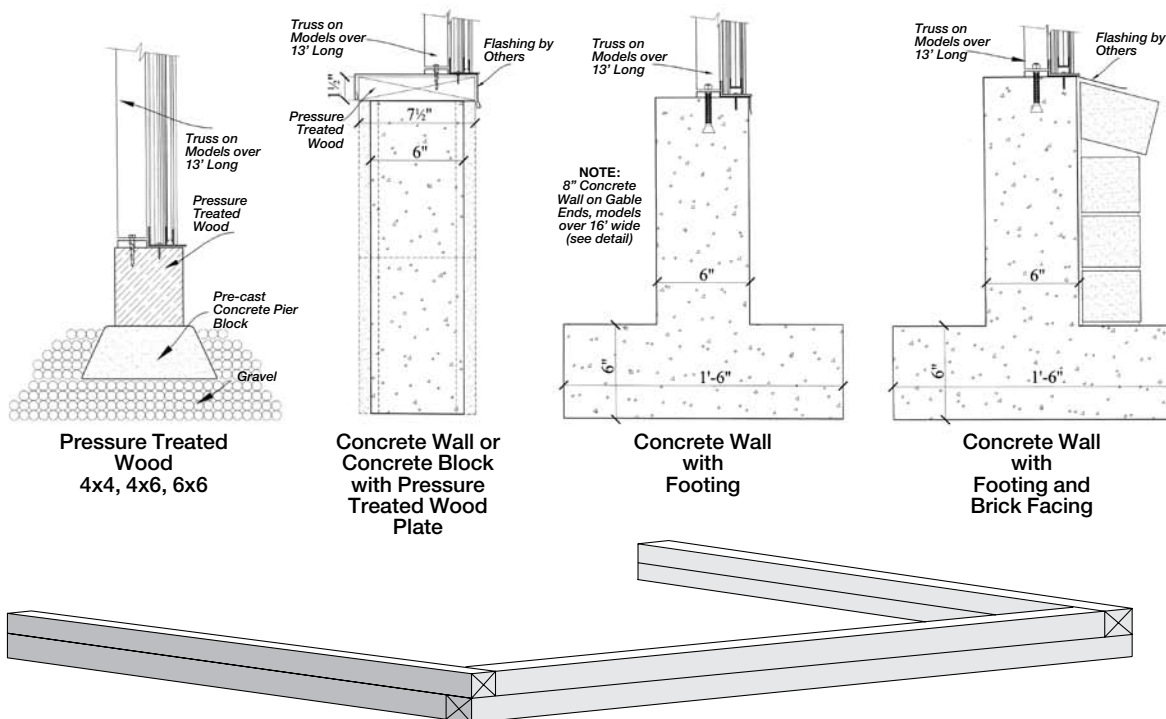

PRE-TREATED WOOD FOUNDATION

# *Pressure Treated Wood*

## *WHAT IS NEW ABOUT PRESSURE TREATED WOOD?*

As of January 2005, the chemicals used in pressure treated wood have been changed. Previous wood was treated with arsenic. However due to the potential long term health hazards this has been discontinued. New pressure treated wood is treated with copper.

*The copper in the 'new' wood will be CORROSIVE TO ALUMINUM as well as other metals.*

What are 'Greenhouse Friendly' solutions to the new pressure treated wood?

- 1 If you are using the new pressure treated wood, you must place a barrier between the wood and your aluminum frame. Popular barriers include 10 mil thick plastic sheeting, steel weather flashing, a rubber or foam weather membrane, or a row of weather resistant non-treated wood such as cedar or hemlock.
- 2 Other weather resistant non-treated woods are popular alternatives to pressure treated wood. These contain no harmful chemicals and will outlast pressure treated wood. Cedar timbers are a popular choice for greenhouse foundations.
- 3 Concrete foundations have always been suitable foundation alternatives for greenhouses. They can vary from poured concrete slabs, poured concrete perimeter walls to concrete block walls. Although these are usually more costly than wood alternatives, they have the benefit of lasting a lifetime. As they are usually considered a permanent foundation, it is important to check with your building codes to determine what you are able to build.

If you have any questions about using the 'New' pressure treated wood in conjunction with our aluminum greenhouses, please contact our office at 1-888-391-4433.

# Assembly of Aluminum Frame

## A. BACK GABLE END ASSEMBLY

Lay out the back pieces into the shape of the end wall. *Refer to the line/detail drawing.*

1. For the curved glass end bars, the flat surface should lie on the ground (*See the example to the right. Use the curved end bar with an angle cleat attached to the side*).
2. Bolt the Glass Bars on the top first (*See Detail #1 & 1A, Page 8*).
3. Bolt the base/sill to the bottom of the Glass Bars (*See Detail #2, Page 8*).
4. The angle brace is bolted approximately 56" from the base. The slider brackets that have already been fastened to the poly end bar curve will determine the height (*See Detail #3, Page 8*). When bolting the horizontal cross brace onto the back wall, measure the back wall so that it does not sag (*See Detail #4, Page 8*).



### Back Gable End Line Drawing Assembly Procedure

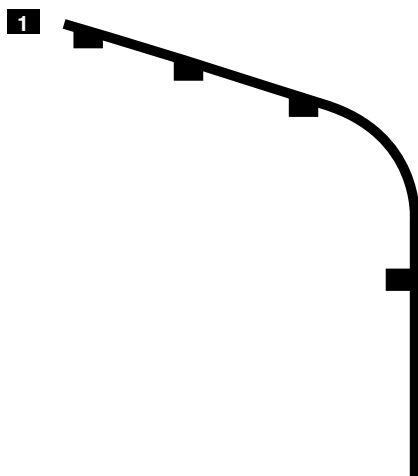

Curved Glass End Bars

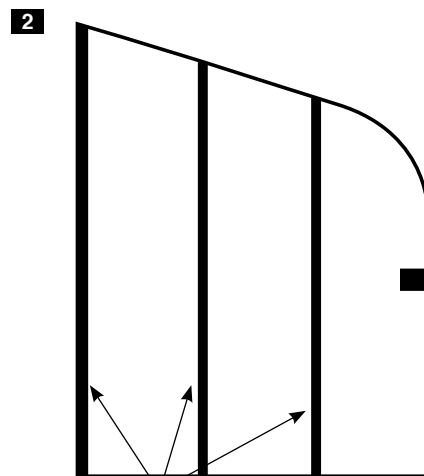

Glass Bars

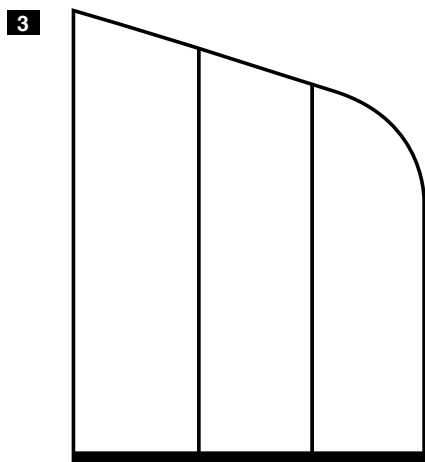

1" x 2" Angle Base

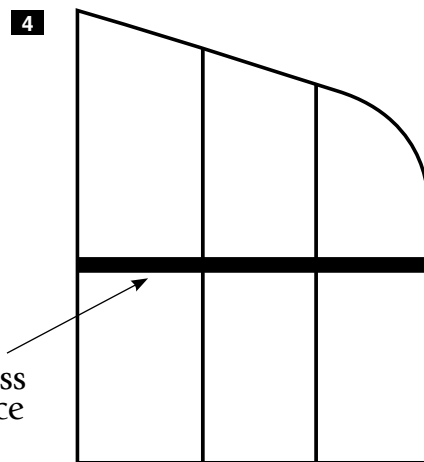

Cross Brace



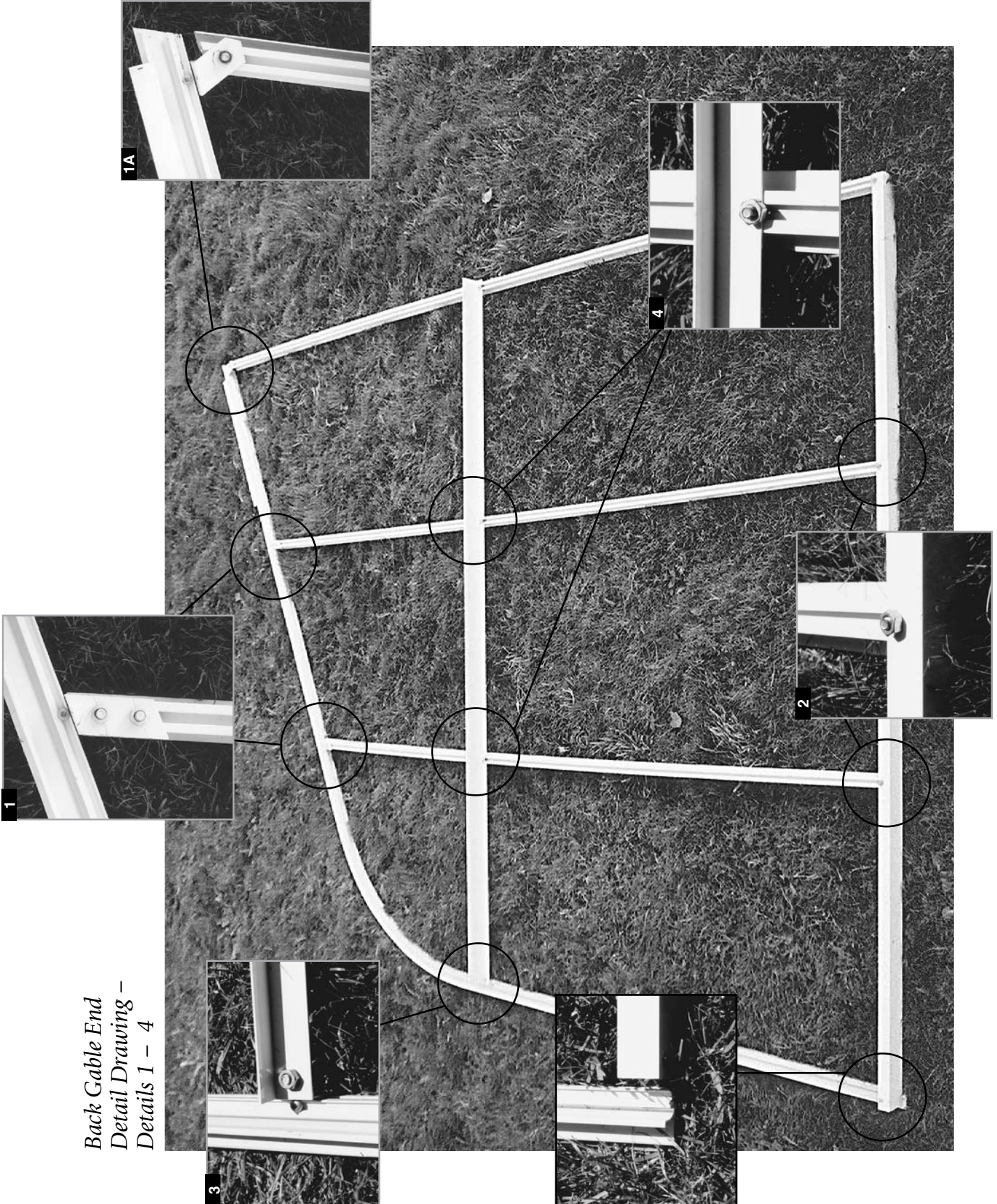

*Back Gable End  
Detail Drawing –  
Details 1 – 4*

## B. FRONT GABLE END ASSEMBLY WITH DOOR

---

1. Lay out the front pieces of the greenhouse into the shape of an end wall. The door frame and all the Glass Bars have a track for the bolt. The track must face up when you assemble the gable ends. Slide the bolts into the track of the bars or use the notches that have already been punched out in the bars. *(Refer to the line/detail drawing on the following page. The order of assembly is represented by dark lines. Detailed pictures are on page 11.)* When you are assembling the greenhouse, you can view the sketches and drawings from the inside the greenhouse. Bolt the bottom plates (4 holes) to the base/sill and the door frame sides using 1/4" x 1/2" stainless steel bolts *(see Detail #5, page 11)*. Before tightening the bolts, be sure that it is square (If you ordered a greenhouse with a door drop, measure from the bottom of the door frame to the underside of the base according to the specified distance).
2. At the top of the door frame, put on the door frame header (which looks the same as the side pieces). Put the header between the two side pieces and bolt on the plates (6 holes). *(See Detail #6)*. The plates should stick up 1" above the door frame. Note how the plates are put on *(See Detail #7)*. Before tightening the bolts, be sure to square up the sill to the door frame.
3. Take all the Glass Bars and bolt them to the base/sill. The angle cut should match the roof slope *(See Detail #8)*.
4. The 1" x 2" angle above the door (49 3/4" long) can now be bolted on. The 1/4" round holes should be lined up with the holes in the plates. Each end of the 1" x 2" angle has a slot punched out to accommodate the bolt. This slot lines up with the bolt track in the back side of the Glass Bars. Slide a bolt in the top of the Glass Bar and fasten the angle to it *(See Detail #6 & 9)*.
5. **Curved Glass End Bar.** Each glass end bar has at least one small aluminum bracket attached to it with two 1/4" holes drilled in it. These pieces line up with the upright Glass Bar(s).
6. When the upright Glass Bars are fastened to the aluminum bracket that is attached to the curved glass end bar, bolt on the short Glass Bar above the door to the 1" x 2" angle.
7. The diagonal bracing can now be bolted on. Remove the bottom nut in the top plate and insert the brace. Then put the nut back on *(See Detail #4 & #9)*. Bolt the other end to the 1/4" hole in the base using a 1/4" x 1/2" bolt *(See Detail #10)*.

**NOTE:** *You may want to fasten a temporary brace across the bottom of the door frame to keep them together. This can be a piece of wood, make sure that the opening is the same as on the top of the door frame.*

### Front Gable End (with door) Line Drawing Assembly Procedure

**1**

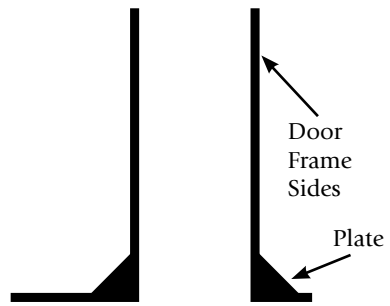

**2**

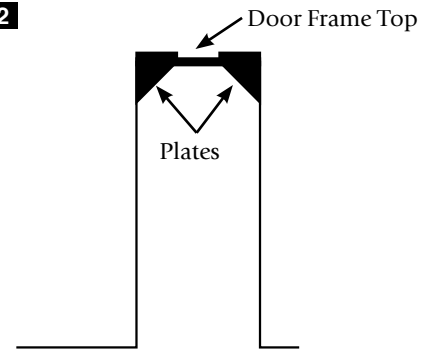

**3**

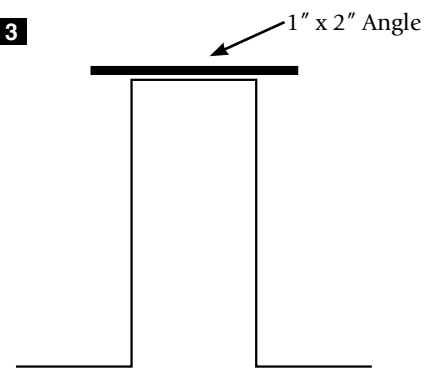

**4**

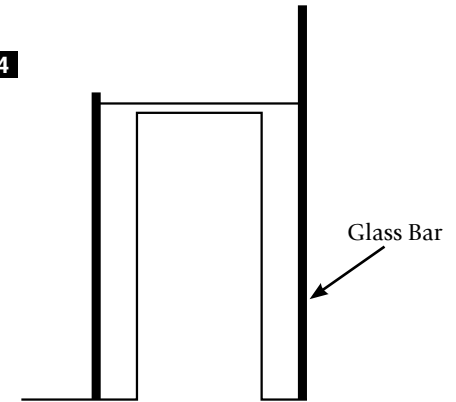

**5**

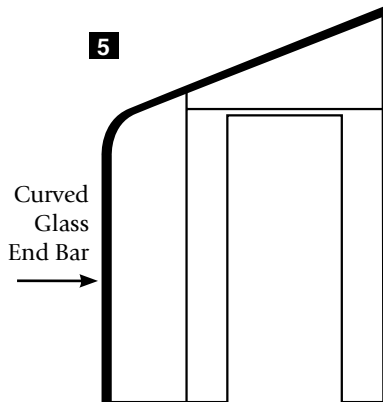

**6**

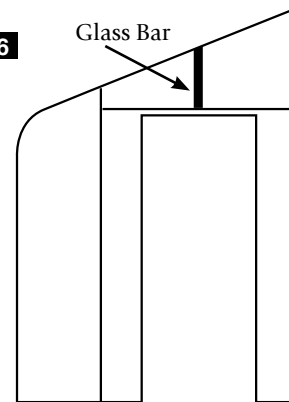

**7**

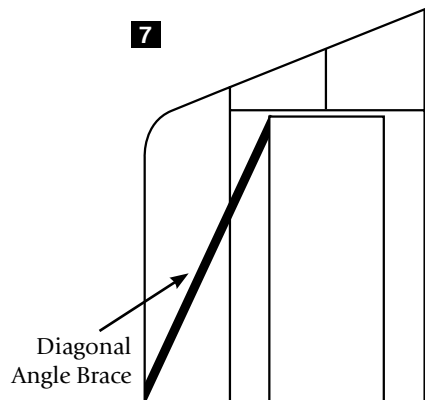

Front Gable End (with door)  
Detail Drawings  
Details 5 – 10

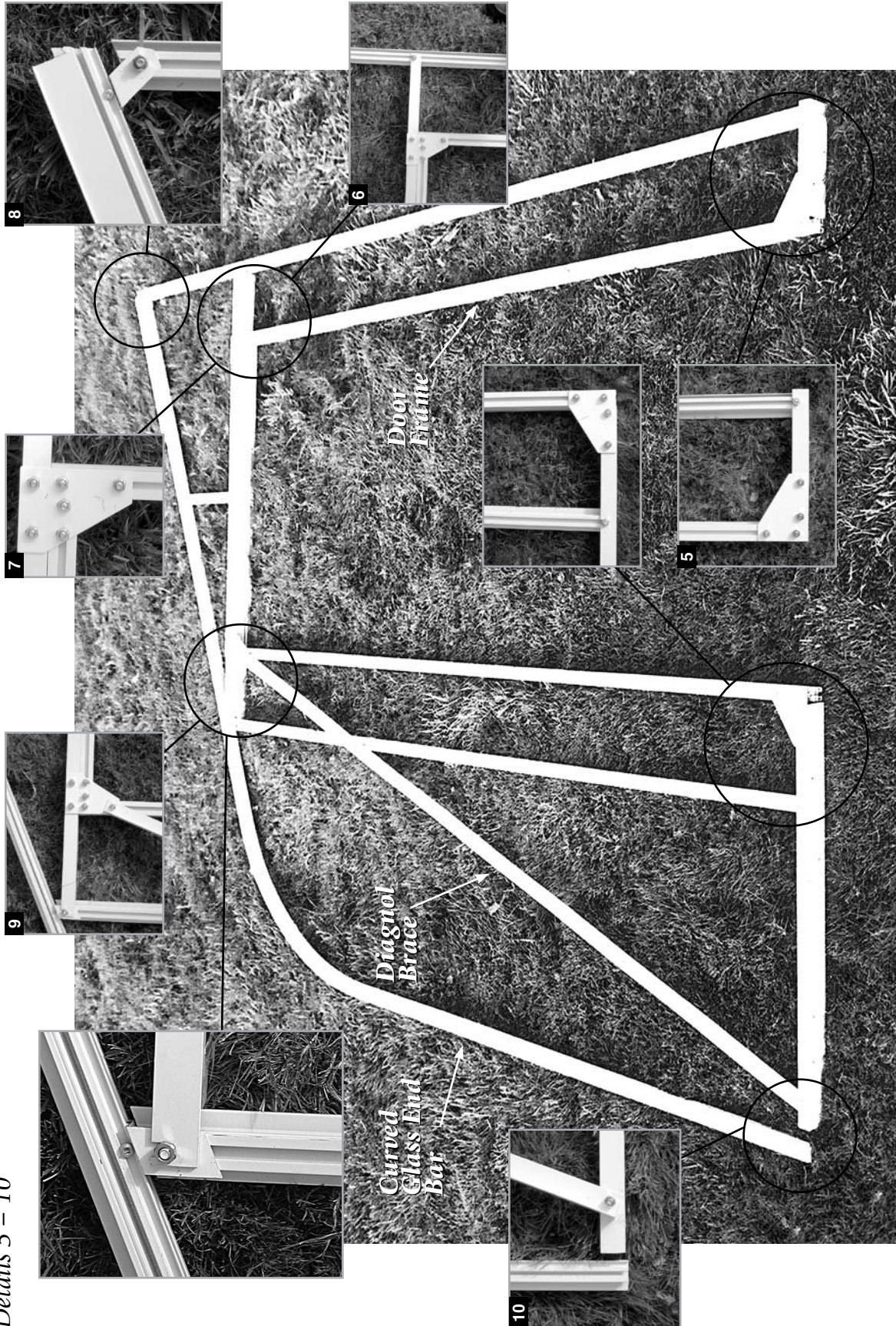

### Door Frame Assembly

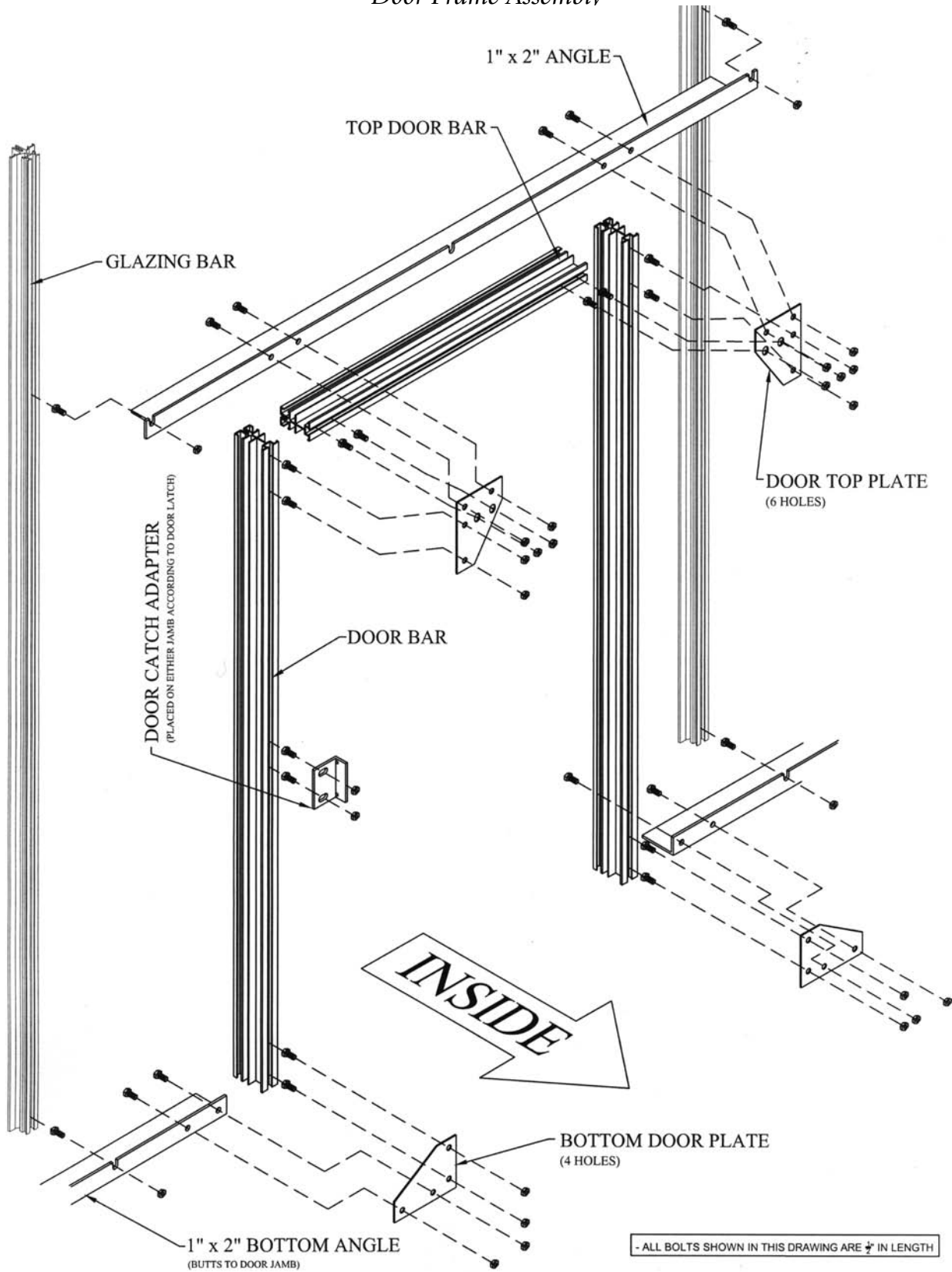

### C. TAPING GLASS BARS WITH FOAM

Tape all the aluminum Glass Bars with 1/8" foam tape. The curved glass end bars tape on one side only. All other Glass Bars tape on both sides. Take a roll of tape and start at one end and press on the bar. *Make sure that the aluminum is dry.* Taping it at this time, you can still move all the pieces in the shed or undercover if it is raining.) Slowly roll down the tape toward the outer edge and press it down at the same time. (See pictures below) Be careful because sometimes the edge of the paper is quite sharp. Do not remove the paper until later.

**NOTE:** Do not tape the place where the Glass Bar is notched out.

When all bars are completed, including the end walls, go to Step #1 of the aluminum frame installation on the next page.

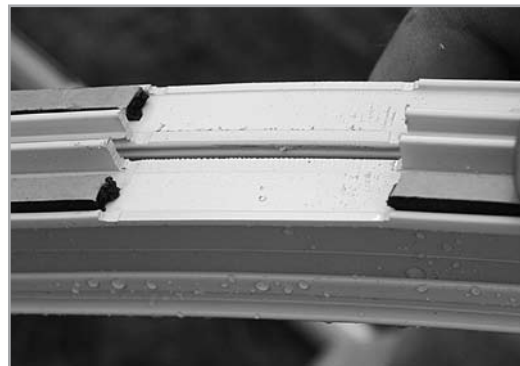
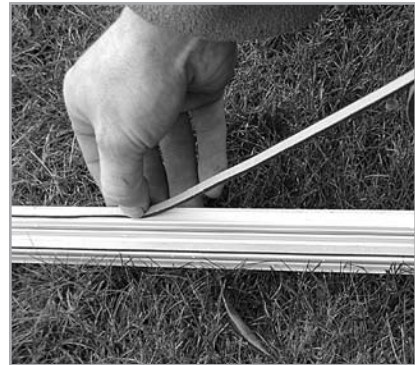
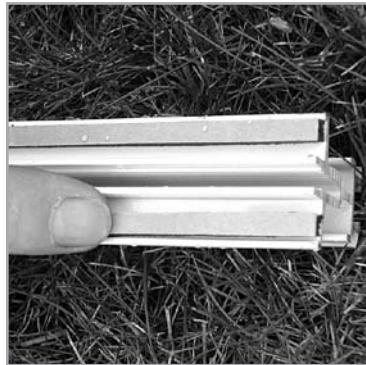
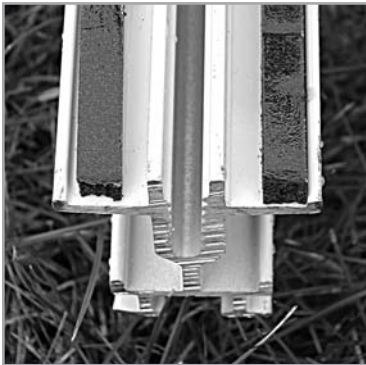

**Do NOT** put foam tape along the **End Bars**. The glass slides under the lip and needs to be sealed when the greenhouse is finished

# Aluminum Frame Installation

Check that the foundation is level and square. If your foundation is larger than the greenhouse, mark a line on it with a pencil or with a chalk line. Take a caulking gun and put in a tube of caulking. Cut 1/4" off the top at a 25-degree angle. Then put a bead of caulking on your foundation approximately 1" in from the outside of the foundation or the marked line. **DO NOT CAULK THE DOOR OPENING.** Measure your door opening in the front.

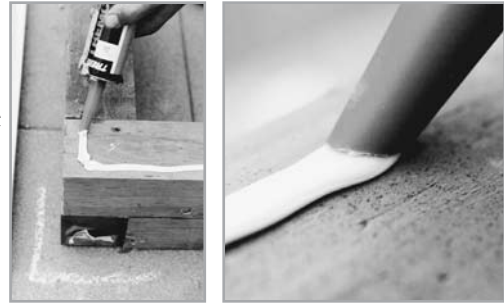

## 1. SIDE BASE/SILL

Lay down the aluminum side base/sill flush with your base on the line you have marked out. Push down on it so that the caulking squeezes out. *(See Step 1 Detail, page 14.)*

## 2. FRONT GABLE END

Stand up the door end, flush with your base or marked line. Slide up one bolt in the bottom of curved glass end bar (front). Take the end bar and push it into the side base where it is notched. The back of the bar lines up with the first slot in the side base/sill. Slide the bolt down and fasten it. When you are lined up and in the right place, screw down the front base/sill using the screw holes that are already there. Then put one screw in the side base to hold it in place. When you have fastened down the front, it should stand by itself. (If it is windy, you will need another person to hold up the front, or you can use a stepladder so that the front can lean against it.) Next plumb the glass bar against the wall and put in 1" screw for now. *(NOTE: after the greenhouse frame is up, double check for square and plumb. Seal behind the glass bar and the ridge, then put in all the screws.)* *(See Step 2 Detail, page 15.)*

## 3. BACK GABLE END

Follow the same procedure for the back gable end as you did for the front. When you have bolted it to the side base and it lines up flush with your base/sill or marked line, then you can proceed. Fasten the base/sill down to your foundation with the 1" screws that are provided. When fastening the side/base sill to the foundation, be sure that the base is straight. *(See Step 3 Detail, page 15.)*

## 4. RIDGE

Before you slide in the ridge, put one bolt in the top of each end bar. Take the ridge (*one person at each end*) and slide it between the end bars on the top. You will notice the punched-out slots in the bottom flange of the ridge. The slots on the end line up with the bottom side of the end bar. Now slide in the ridge and slide the bolt into the ridge slot. Make sure that the glass end bar is tight against the ridge – use a 7/16 flat wrench (*at this time you can temporarily fasten the ridge to keep it from moving around - measure ridge height, don't rely on gable bars*).

## 4A. SEE APPENDIX A FOR TRUSS ASSEMBLY INSTALLATION FOR GREENHOUSES LONGER THAN 16 FEET.

## 5. CURVED GLASS BAR WITH SLIDERS (1, 2, 3 etc.)

Each Glass Bar (with a vent frame slider) is marked with a number (1, 2, 3 . . .) to correspond with the number on the ridge. Slide the bolt into the top of the Glass Bar and line it up with the slot in the ridge. Move up the bolt and fasten it. Do the same for the bottom of the Glass Bar. Slide in the bolt, lift up the end, and push it into the side base/sill as far as you can. Then bolt it on. Do this for all the Glass Bars with sliders and numbers. The end of the bar should be tight to the base. *(See Step 5 Detail, page 17.)*

## 6. VENTFRAME ANGLE

The ventframe angle is 50" long with the ends cut out to fit between the two Glass Bars with sliders. Put the head of the bolt into the punch out in the glass bar (24" from the top), slide the bolt up and fasten it to the ventframe on the bar. Make sure that the angle flanges are facing toward the sidewall (down) and that it is pushed up against the side sliders (already on the Glass Bar). Do this for all of them.

*(See Step 6 Detail, page 18.)*

## 7. GLASS BARS

Bolt on all the remaining Glass Bars. Make sure that the top and bottom is tight against the ridge and base.

*(See Step 7 Detail, page 19.)*

## 8. GUTTER

The gutter is also used as a spacebar. The gutter is located just below the curve approximately 54" up from the base (*The glass bar should be notched out for it*). Use #8 x 1/2" screws to fasten the gutter to the glass bar (*Keep the gutter to the top of the notch*).

*(See Step 8 Detail, page 20.)*

## 9. ROOF PURLIN (CHANNEL)

When installing the roof purlin, mark it out by measuring from the ridge. The roof purlin should be located approximately 6" above the place where the curve starts (*See drawings provided for purlin locations*). In larger greenhouses, the purlin may be located about the center between the ridge and the top of the curve. Always face the open end of the purlin up towards the ridge so that it can be used for hanging baskets. Every Glass Bar has notches punched out so that the head of the bolts can be inserted and can slide up or down on the bar. (*See Step 9 Detail, page 21.*)

## 10. TAPE ALL GLASS BARS

Complete all taping with the 1/8" foam gasket. **NOTE:** *Side vents need to be installed before taping the bars*

*(See photographs, page 12.)*

## 11. FASTENING / SEALING THE GREENHOUSE TO THE WALL

Before you seal behind the ridge and end glass bars, square your greenhouse using the 3/4/5 method (*see sketch*). Sometimes the foundation is level but your wall is not plumb. You may have to decide to pull the greenhouse away from the wall or make your foundation off-level. When your greenhouse is squared up, mark the edge of the ridge on your wall and pull your greenhouse away from the wall and seal behind it. Push the greenhouse back to the wall and fasten it with screws. **NOTE:** *Sealing can also be done after greenhouse is finished and before the vents are installed.*

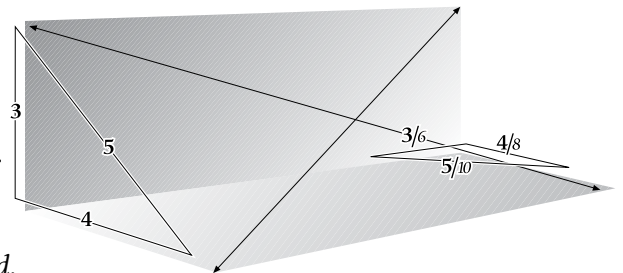

## 11A. SIDE VENTS, INTAKE SHUTTER AND EXHAUST FANS INSTALLATION (IF NECESSARY) SEE APPENDIXES B THRU E. THEN RETURN TO THE NEXT PAGE AND CONTINUE



# Assembly Outline

*Step 1: Side Sill & Base*

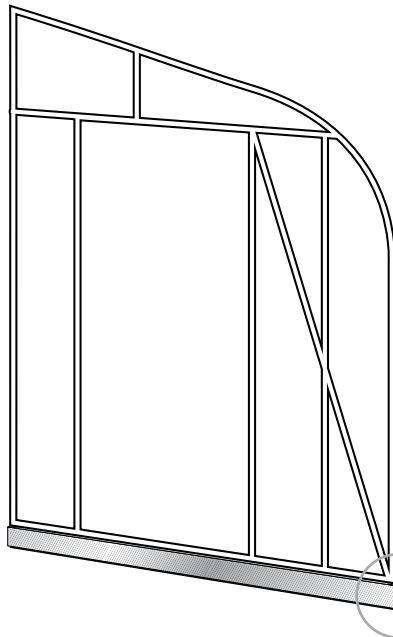
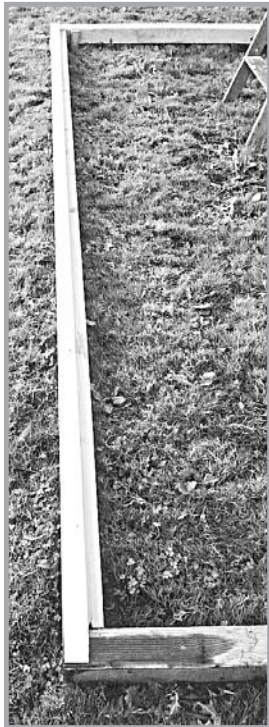
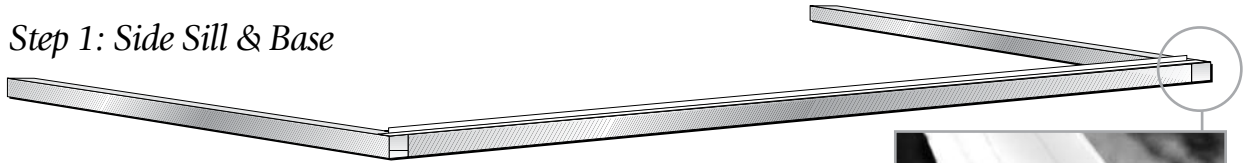

*Step 2:  
Front  
Gable  
End . . . .*

*Step 3:  
Back  
Gable  
End*

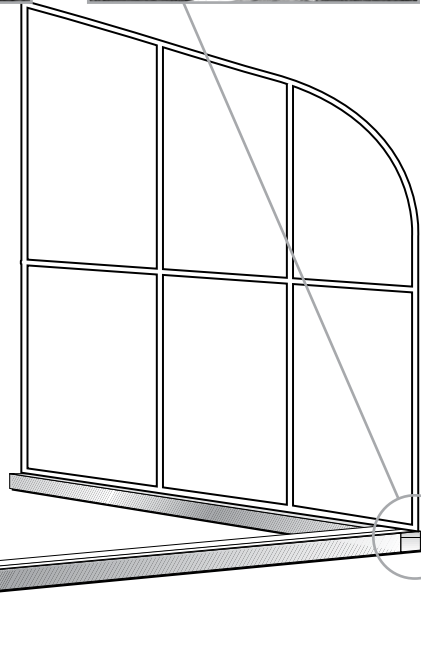

*Step 4: Ridge*

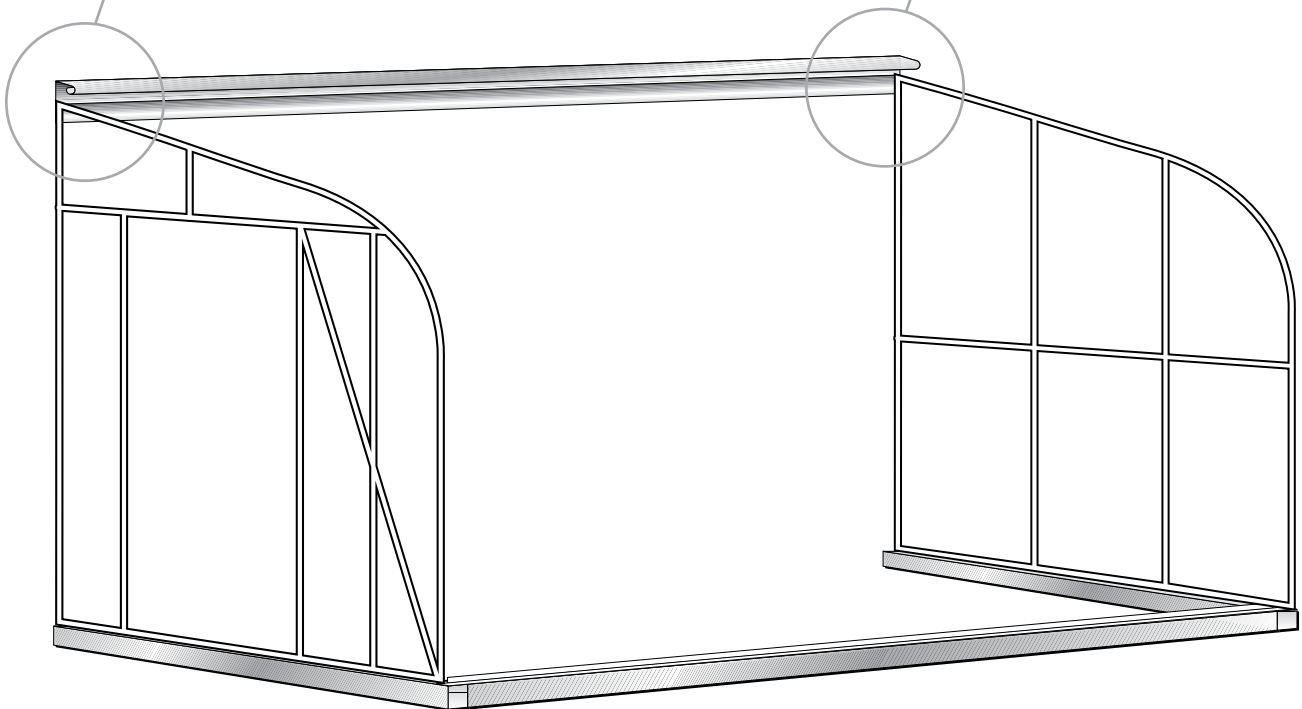
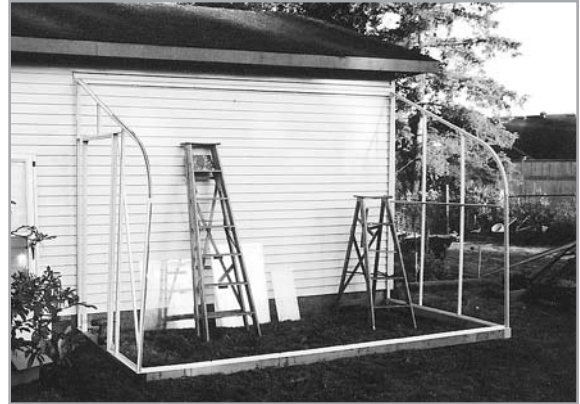

*Step 5: Glass Bar with Vent Frame Sliders*

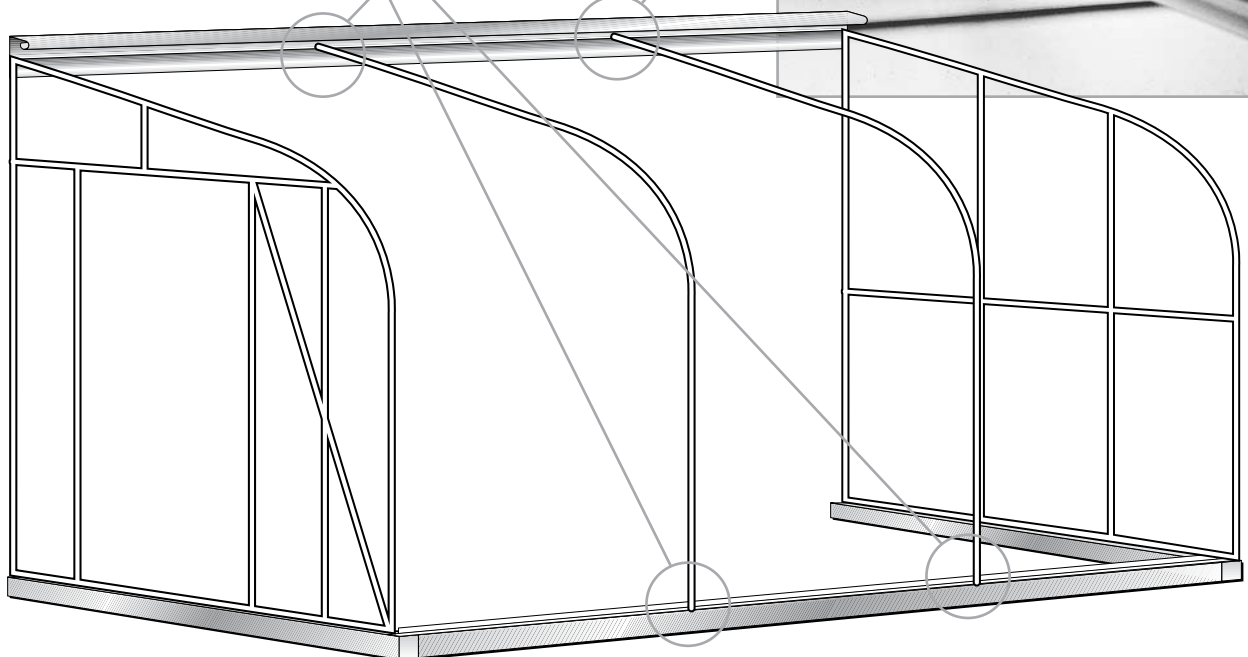
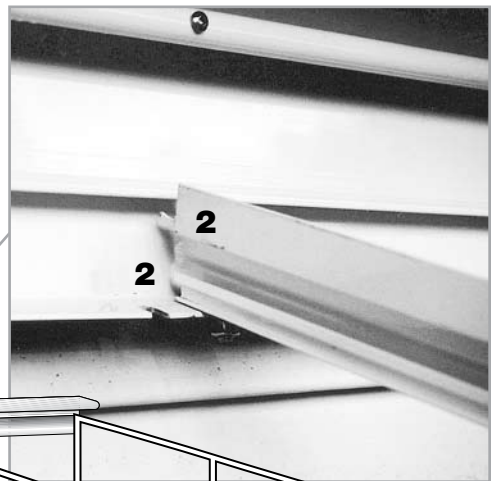

*Step 6: Vent Frame Bottom*

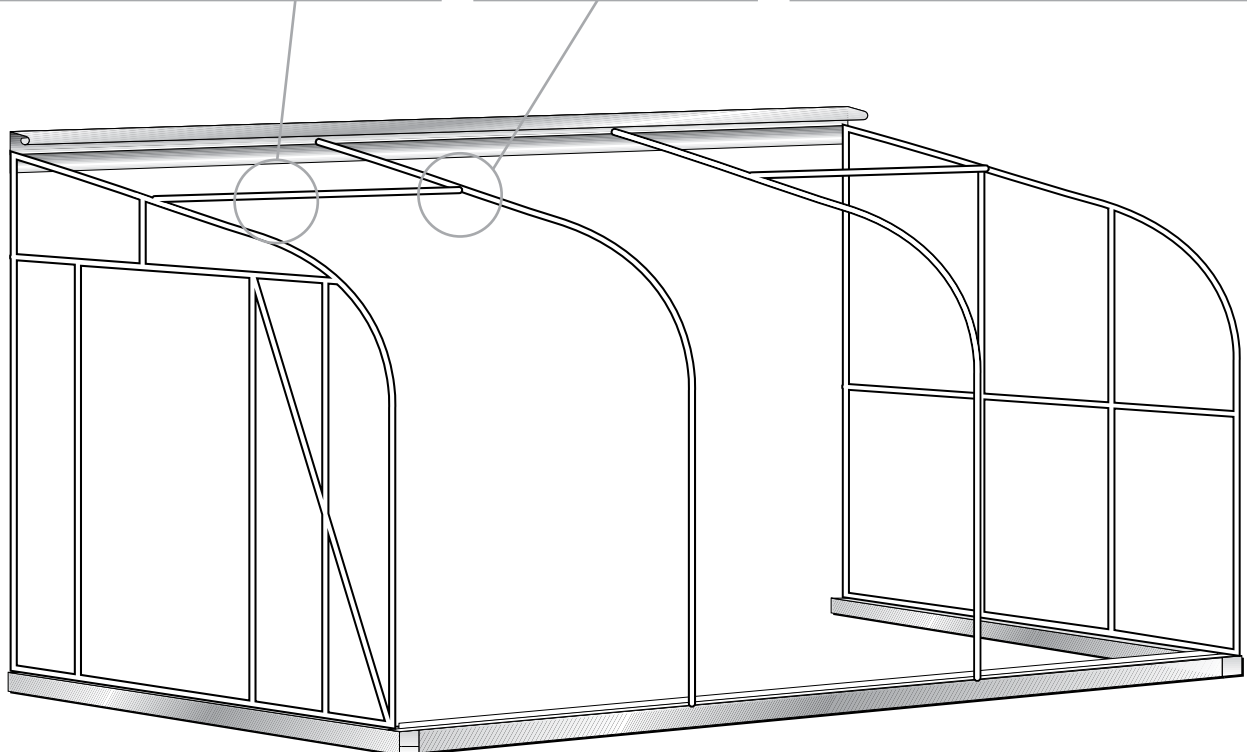
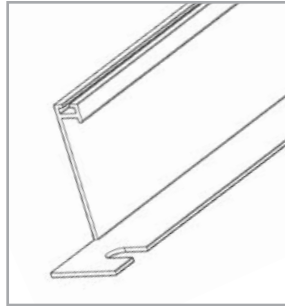

*Step 7: Install All Remaining Glass Bars*

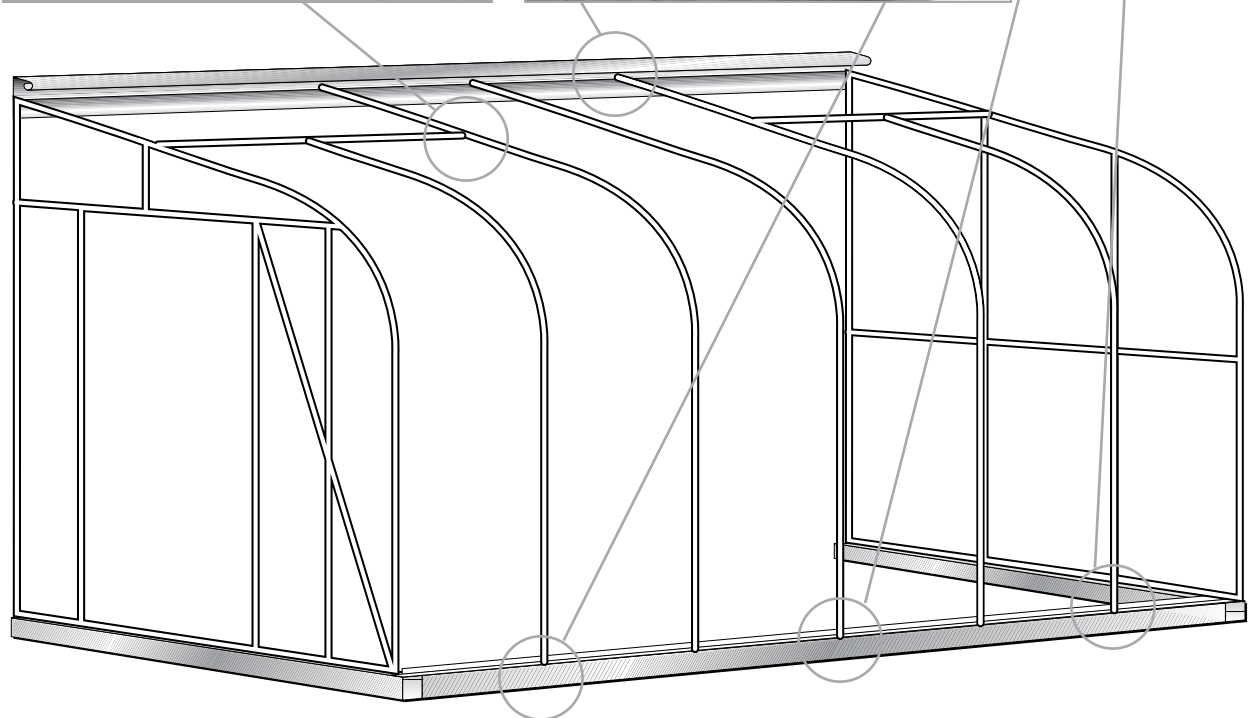

*Step 8: Gutter*

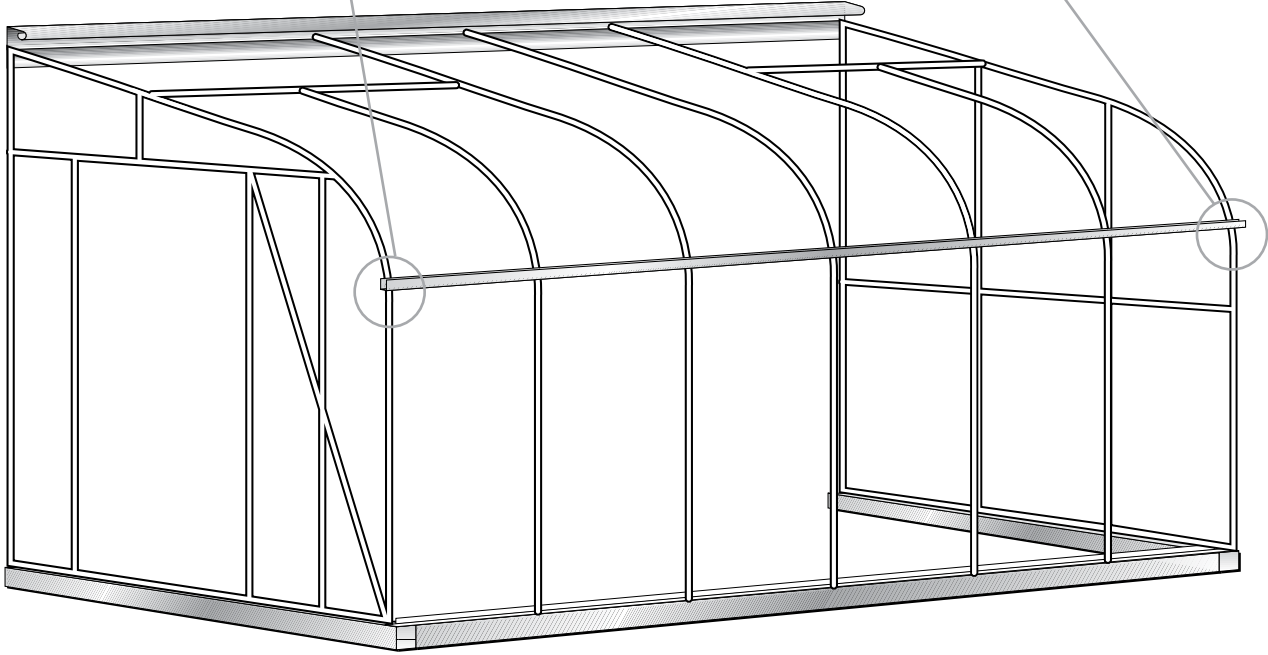
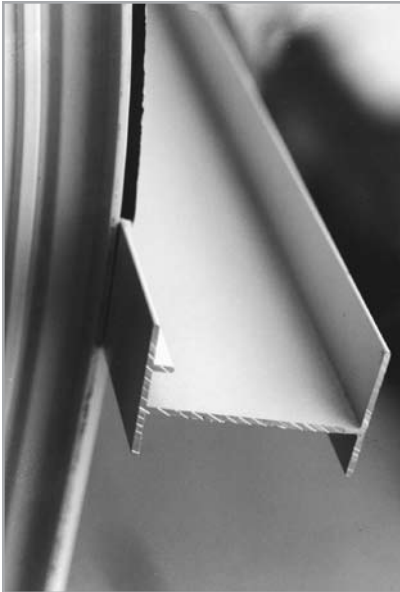

*Step 9: Roof Purlin*

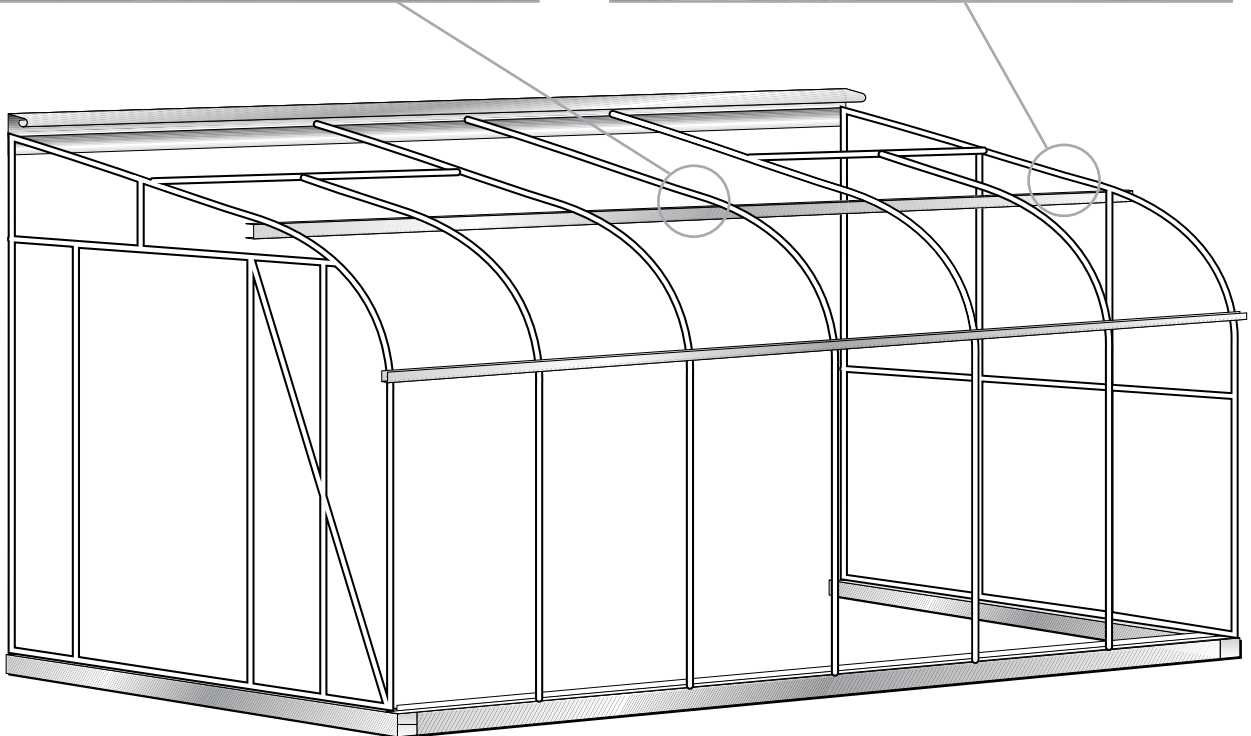
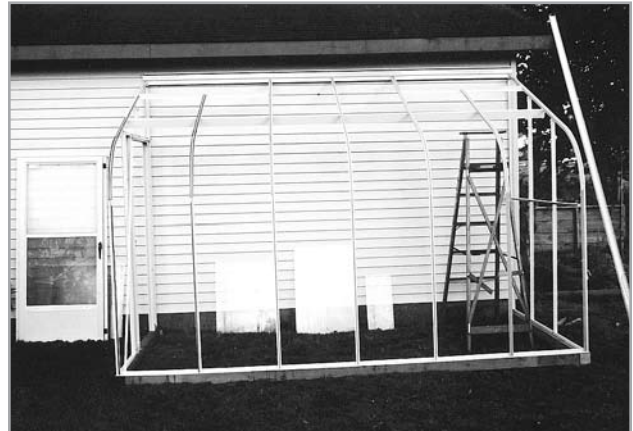

# Glass & Cap Installation

## GENERAL INFORMATION

Glass comes packaged in cardboard cases. When storing glass, put it upright against a wall or post. All glass is a 3mm / 24 oz. thickness (unless it is a special order). When handling glass, put one hand on the bottom and one hand on the side. Do not hold the glass flat in your hands. (*When laying out the glass for your greenhouse, do not lay the glass on your lawn while the sun is shining because the glass will burn the grass.*) The following boxes **1** indicate the picture or illustration that will assist you with your assembly.

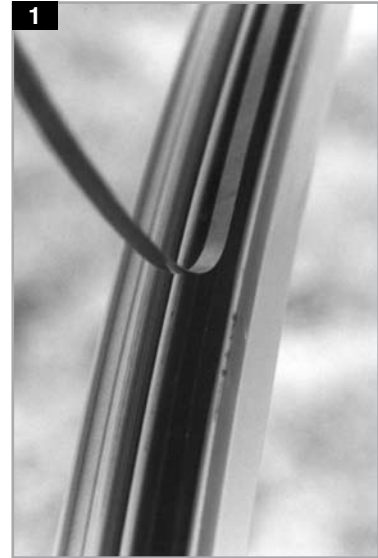

## 12. GLAZING

Remove all paper from the foam strips if you pre-taped it. **1**

## 13. SIDEWALLS (*see the glass sketch for sizes*)

- A. Take a piece of glass and hold it along the long side. Set the 24" width of the glass on your aluminum base against the glass bar and push it gently toward the greenhouse (*see page 23* **2**). If the greenhouse is not square, push the gutter over to square it. If it is a warm day, the foam will stick to the glass and you can walk away and get your aluminum cap. The cap (*see sketch for length*) is pushed against the glass. Use #8 x 3/4" screws to fasten the cap to the Glass Bar. Hold the cap against the glass and put in your screws. When the screw hits the cap, make a 1/4" turn. In other words, *do not tighten the screws too tightly*. Also, do not put a screw in the top hole of the cap. When the first piece of glass and cap is installed, go to the next bay. Finish off the bottom row on one side only. Open the bundle of plastic "H" and push one over the edge of the glass **3**. Sometimes the plastic "H" is a little too tight to push on. If so, use a screwdriver to open it up a little **4** (*See the pictures on the next page*).

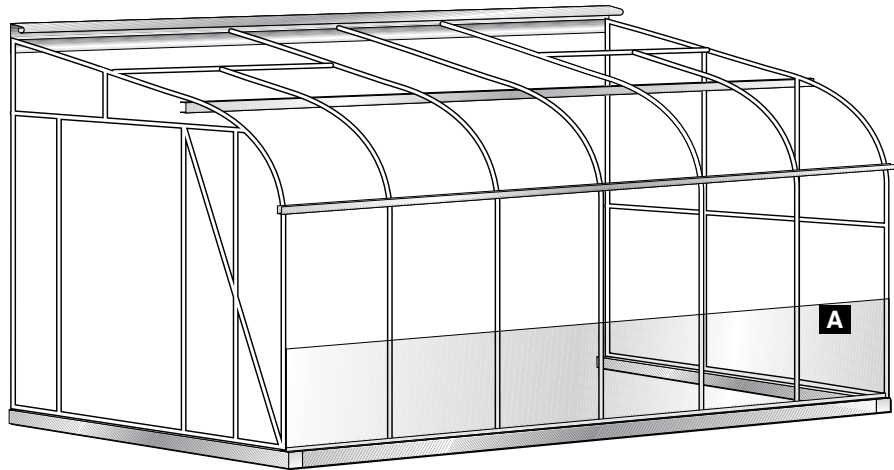



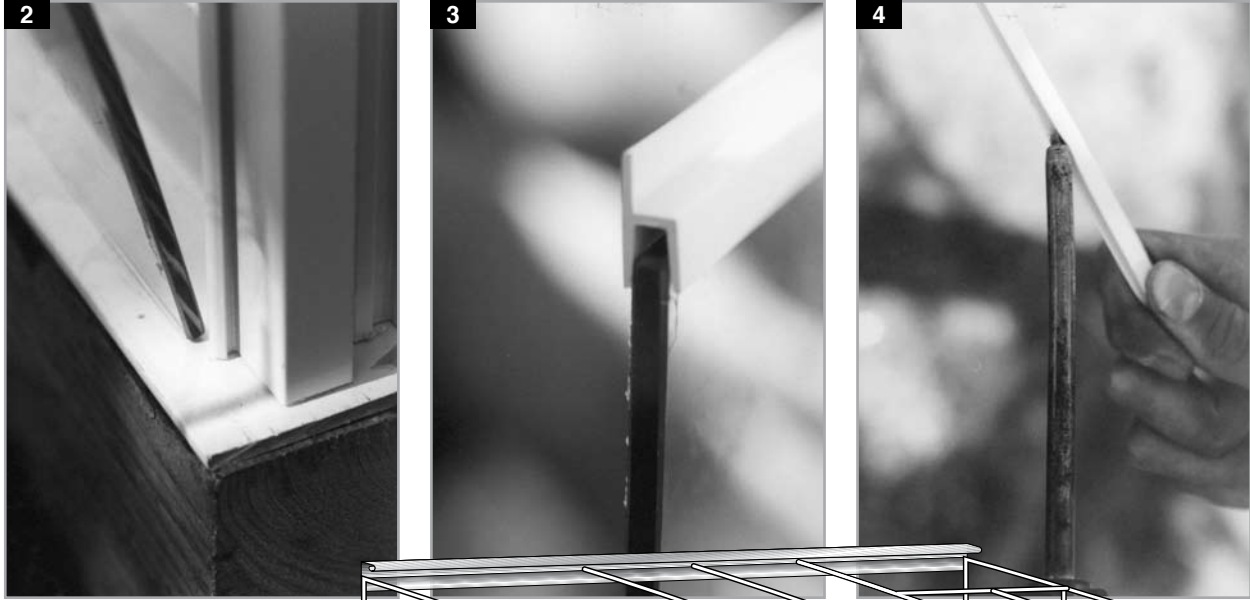

- B. Install the next row of glass, setting it on top of the plastic "H". Take the aluminum cap (for length, see the sketch). Use the bottom hole of the second row of caps and line it up with the top hole of the first row of caps. Again, do not tighten the screw too tightly. For a standard greenhouse, this row will finish off the sidewall below the gutter. Sealing off the glass against the gutter is done at a later time.

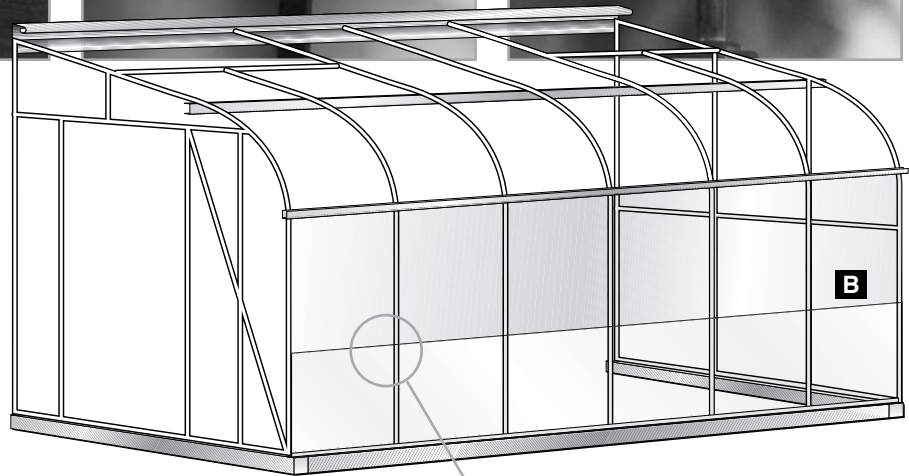

- C. Set the curved glass inside the gutter on the lip that is sticking out. When you set the curved glass on the gutter **5**, push the glass towards the aluminum frame. The frame should be square, if not, go to the base or ridge and push it over to

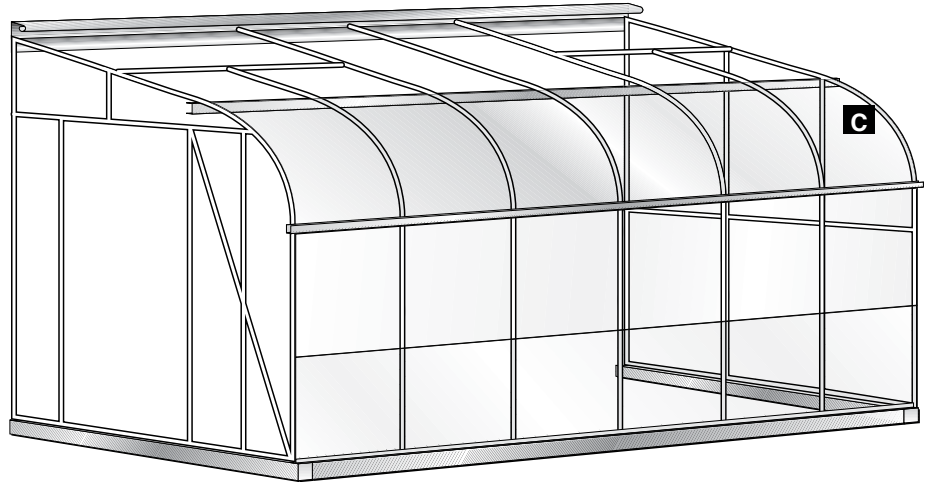

make it square to the glass. When putting on the cap on the end bars, be sure that you have put two / three rows of foam on the outer edge of the end bar. Otherwise, the aluminum cap will be twisted crooked **6**. Work carefully as the curved glass does not have as much bending tolerance as flat glass. When you fasten on the curved aluminum cap, do not screw it too tightly. You do not want to put too much pressure on the glass. When an aluminum glass bar is bent, the tempering of the aluminum may vary somewhat and the glass bar may not be *exactly* the same radius as the glass. Therefore, you need to take extra care when you install the curved pieces. If the glass does not fit solidly onto the foam rubber, just lift the glass off, put on a second row of foam (usually in the middle of the curve) and reinstall the glass.

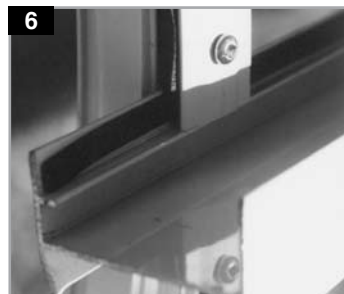
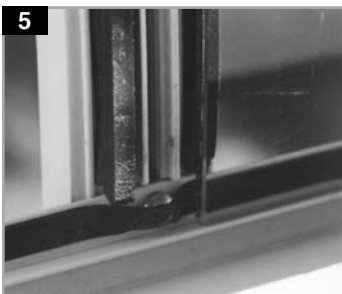

D. The next row of glass (see the sketch for size) overlaps the curved glass by 1/2". Therefore, the curved cap is 1/2" shorter than the glass **7**.

Cut a 6" piece of foam strip and lay it on top of the existing foam, starting with one end against the

edge of the curved glass. This will eliminate any air drafts due to the overlap of the glass **8**.

Lay the next glass against the curved aluminum cap (giving you a 1/2" overlap). The aluminum cap for this row has a slight bend in one end **10**. This bend makes it easier to fasten it to the curved shape of the previous cap. Again, the bottom hole of the aluminum cap should line up with the top hole of the curved cap **9**. The size of the glass is on your glazing sketch. When you do this row of glass, the glass below the vents may be a different size.

**NOTE:** Every row of glass in the roof is done the same way. The glass always butts against the

aluminum cap and the aluminum cap top hole lines up with the next cap's bottom hole **9**.

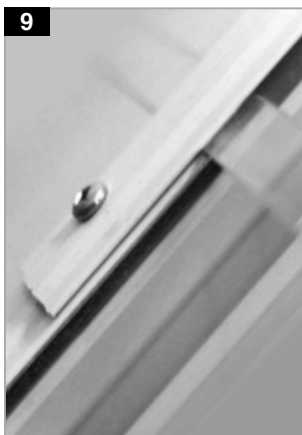
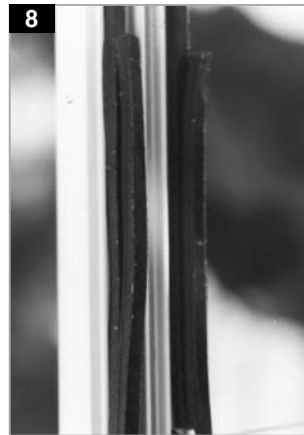
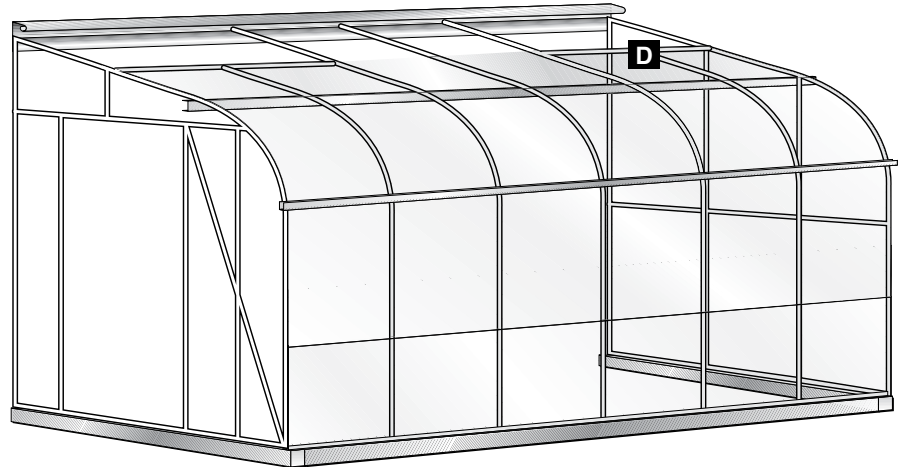

- E. Install the last row of glass. The top edge of the glass slips under the ridge flange.

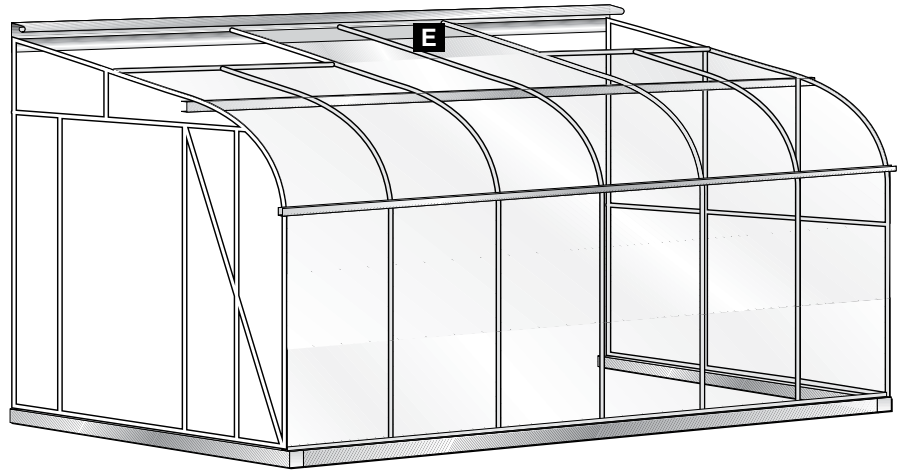

#### 14. ENDS

##### BACK:

The first row of glass is the same height as the side glass. The corner glass slides behind the end bar flange. (No cap is required.) **11** Put on the plastic "H" and install the next rows. (See the glass sketch.)

##### FRONT:

Glazing is exactly the same for the front as it is for the back except that the front has the door. The glass beside the door fits into the first slot in the doorframe. (See the glass sketch.)

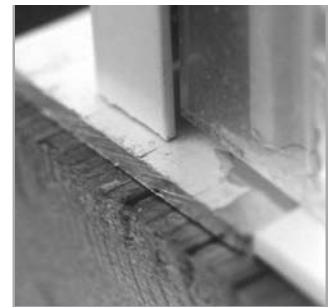

#### 15. SEALING THE GREENHOUSE (after all the glass is installed)

Caulking is used for sealing aluminum to the wood/concrete base and against the wall (see picture on page 12).

For most people, silicone is easier to use for sealing glass to aluminum. The areas that need to be sealed with silicone include:

- On the front and the back of the endbars **12**
- Around the ventframe **13**
- Below the gutter
- Along the ridge where the glass slides under the flange
- Around the doorframe **14**
- Doorframe beside the base / sill **15**



**NOTE: Do not seal the glass to the base as the water needs to drain out.**



# Door Installation

(Refer to the drawing on next page.) Take the door and set it inside the doorframe. Lift it up as high as possible on the hinge side and put the screws through the existing holes in the doorframe. Now the door will hang by itself.

Remove the plastic clip from the "Z" bar and put one screw into the doorframe to hold the "Z" bar. Open the door, take off the clips and put back the screws. Close the door and check that it is square. If the frame and the door are square, then fasten the "Z" bar to the frame. If not, move the "Z" bar up or down to square it. If this is not enough, loosen the bolts in the top plates and move the frame to make it square. When it is in place, tighten all the bolts.

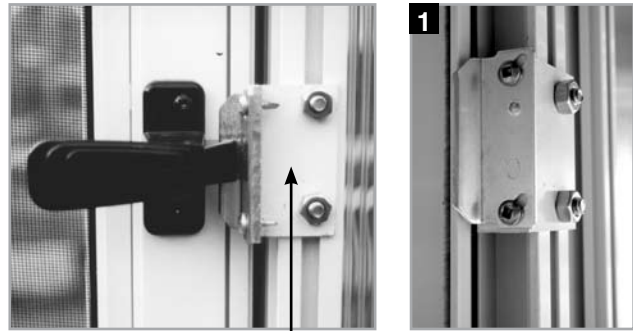

Door Catch Angle

Next install the door handle (see the instructions inside the box). To install the door catch angle, slide in two bolts into the back of the door frame. Bolt on a small angle (provided with the door handle). Face the angle towards the door, line it up with the center of the door handle, and then tighten the two bolts (see picture to the right). Take the door catch out of the door handle box and screw it on. Close the door and adjust the door sweep at the bottom of the door to eliminate potential gaps.

**NOTE:** There are two types of manufactured doors. The door catch angle on the white door may have to be turned the opposite way as shown on picture **1**.

Run a bead of silicone under the angle above the door and against the doorframe. Also silicone the "h" on the glass beside the door to ensure an airtight seal.



# Door Installation

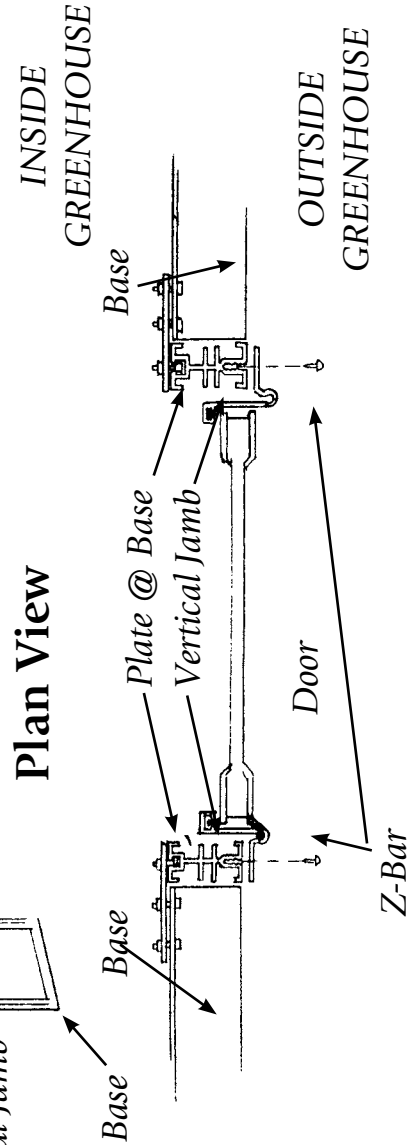
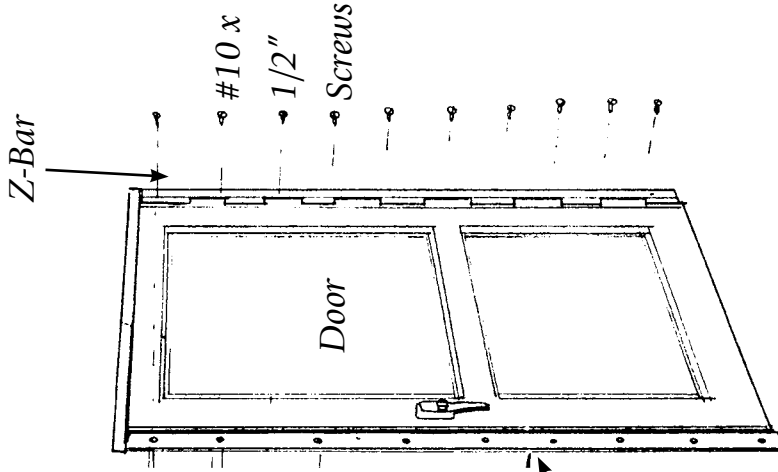
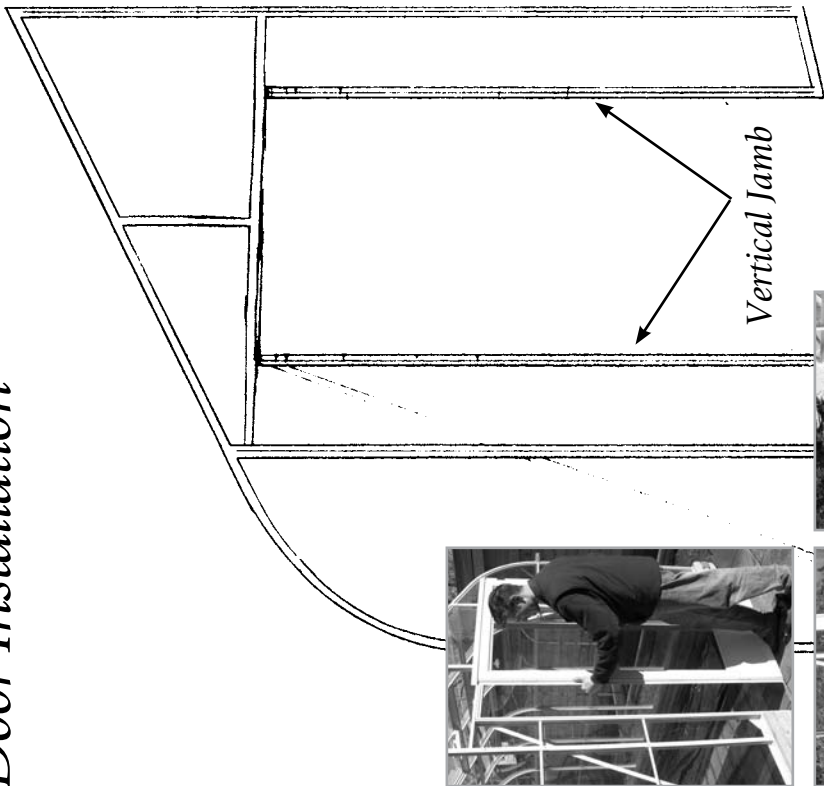

# Vent Assembly

(See Drawing on Page 32)

1. Lay down the vent gutter with the punches facing up towards you.
2. Glass Bars with sliders are for the end. Lay them down with the bolt slot facing up.
3. Lay the vent hinge with the punches facing up towards you.
4. Slide the bolts into both ends of the end bar. Take the gutter and line up the bolt with the first punch, slide the bolt down and tighten it. Do the same with the hinge, the other side and center bar. Make sure that the Glass Bars fit tightly into the gutter and hinge after the vent is assembled.
5. Turn it over and square it up.
6. Put the 1/8" foam on the Glass Bars.
7. Take the glass and slide it up into the hinge track. Drop it down on the gutter. Do the same with the next piece of glass.
8. Take the caps and lay them on the bars, center them and screw them on with a 3/4" screw.
9. Take the silicone gun and seal where the glass slides into the hinge.
10. 3/4" screw through hinge & gutter into glass bars.



## VENT INSTALLATION

Take the vent and slide it into the end of the ridge (See Picture **A**).

After you remove the screw in the ridge, push it into place and put the screw back in (See Picture **B**). Now attach the automatic opener.

# Vent Opener

## INSTALLING THE BAYLISS AUTOMATIC VENT OPENERS

Detailed instructions are included in the box with the control (there are a few extra parts).

Use #10 stainless steel screws to fasten the Bayliss and the vent sill ① and the vent ②. All holes are already drilled. After the Bayliss is fastened in place, install the threaded adjuster into the swivel block. This is made easier by lifting the vent with one hand until the piston rod only projects 1/2" through the swivel block.

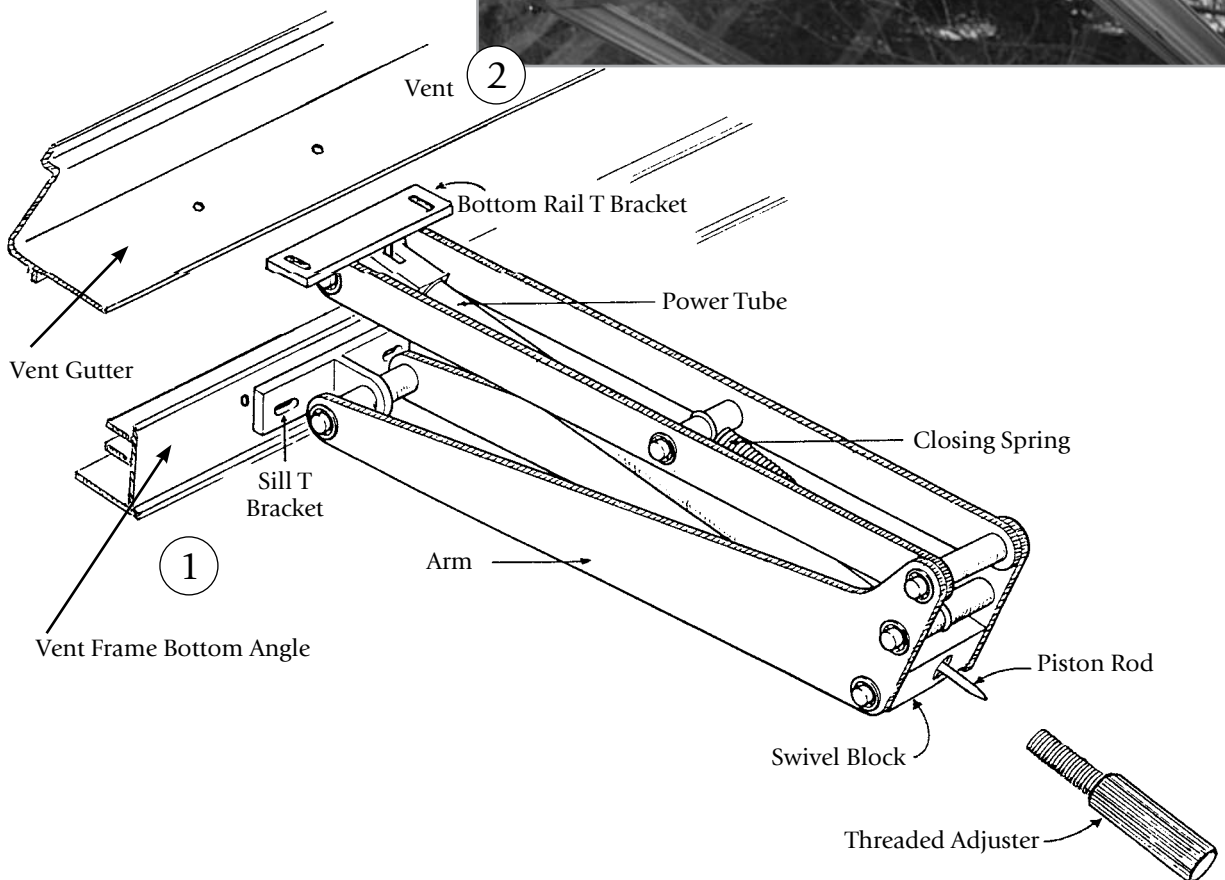



# *Glass Greenhouse Roof Vent Details*

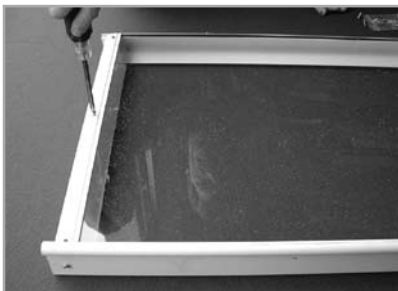
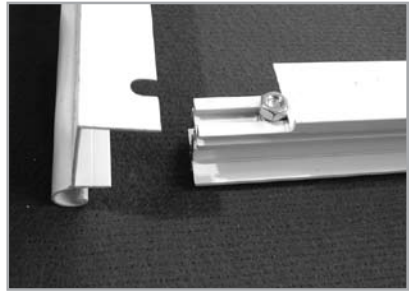
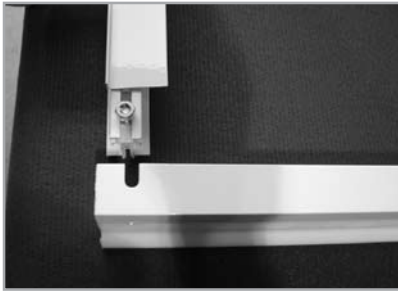
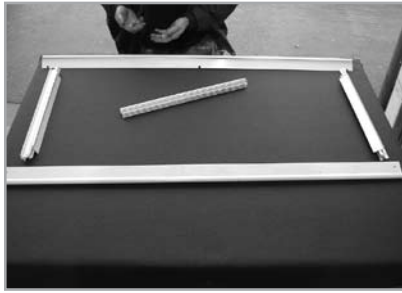

# Vent Assembly - Exploded View

- ALL BOLTS SHOWN ARE  $\frac{3}{8}$ " LONG
- ALL FACE CAP SCREWS ARE  $\frac{1}{4}$ " LONG
- GUTTER END SCREWS ARE  $\frac{3}{8}$ " LONG
- VENT HINGE END SCREWS ARE 1" LONG

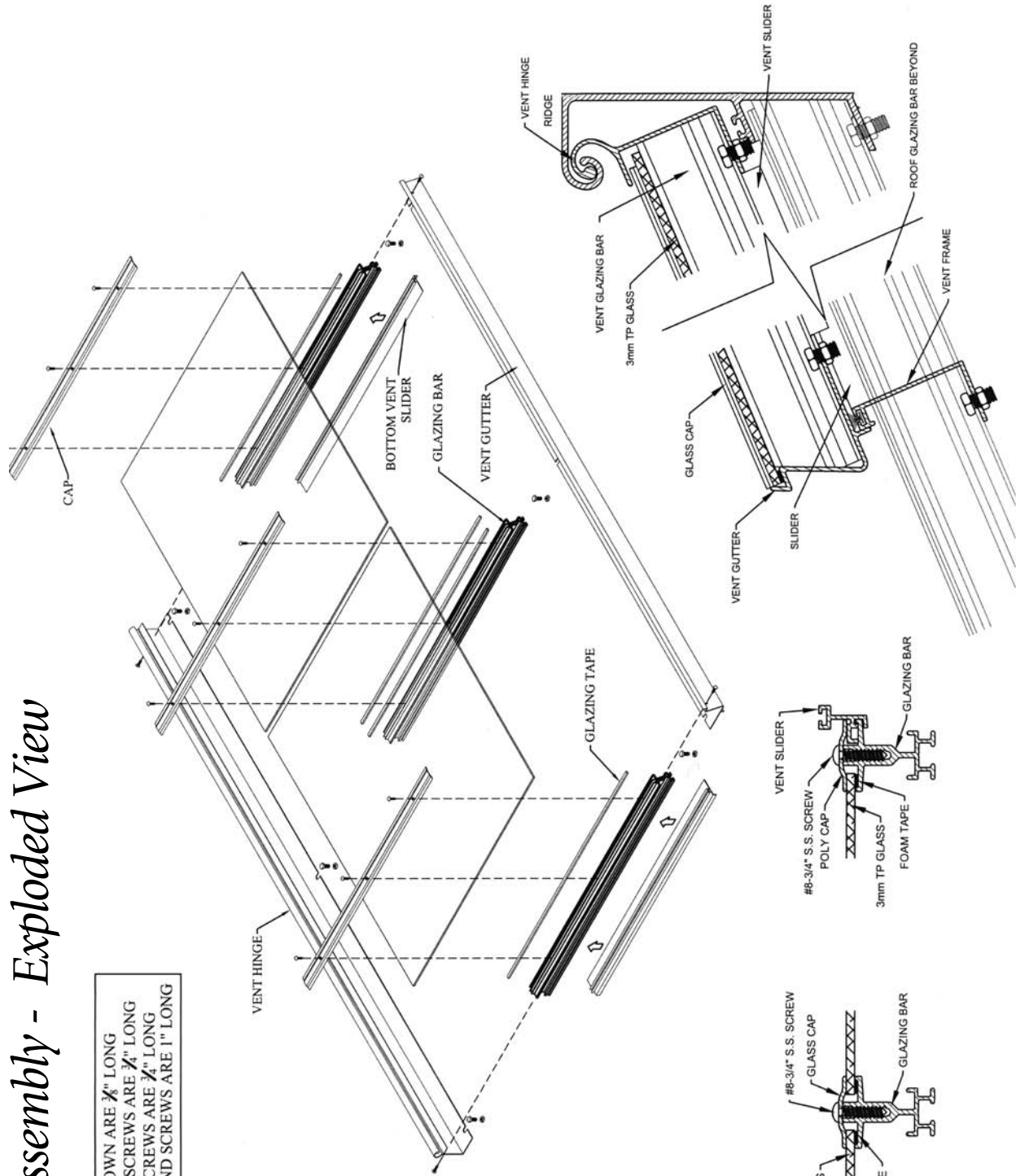

# Appendix A – Curved Lean To Truss

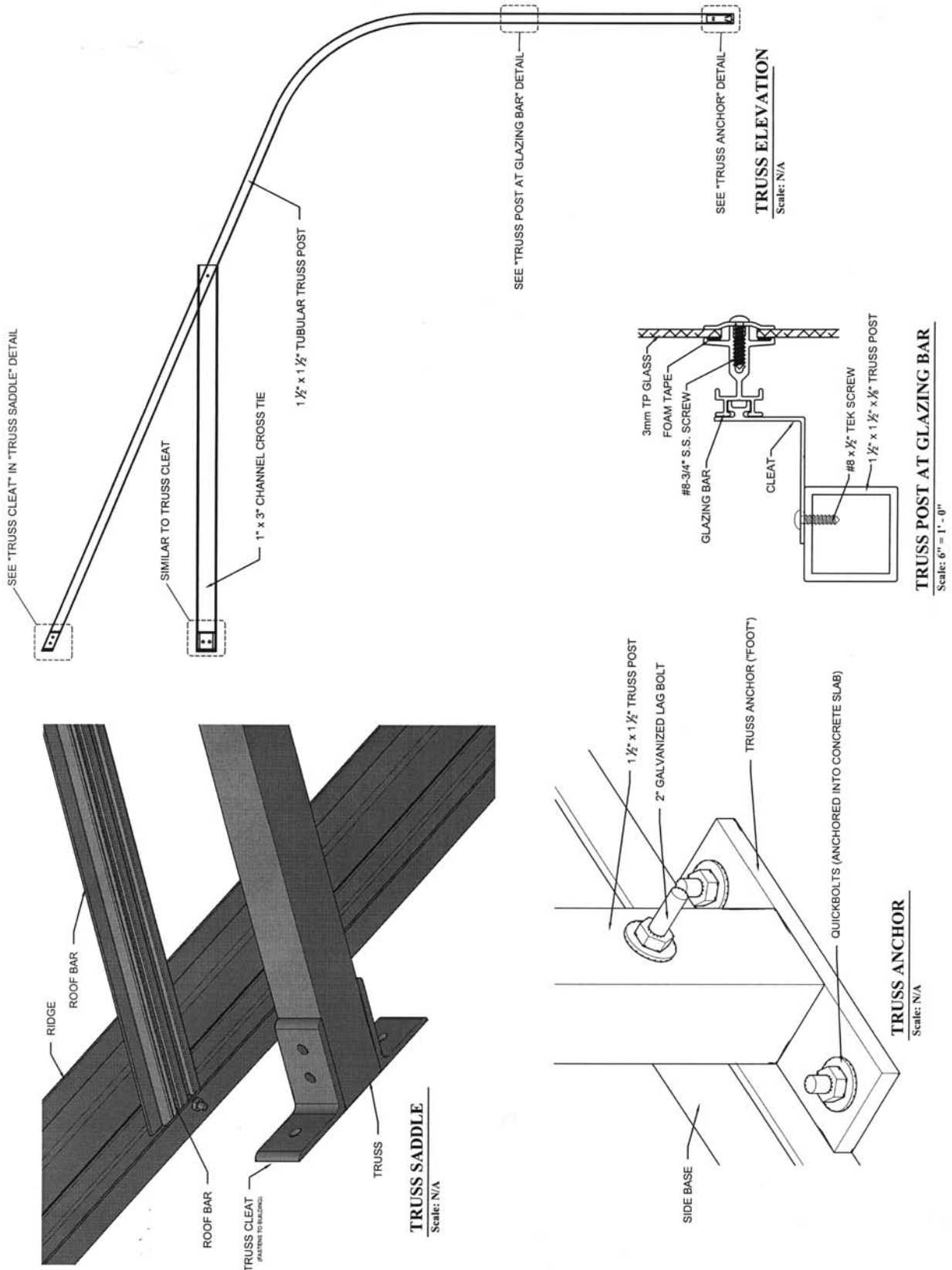

# Appendix B – Motorized Intake Shutter

**NOTE:** Installation of the intake shutter is the same for a glass or polycarbonate greenhouse

- Slide bolts in through notches provided (*a small piece of foam stuffed in track under bolt keeps it from sliding down*).
- Ensure the blades open with flaps facing down.
- Install glass or polycarbonate on frame of intake shutter.
- Seal around the intake shutter after glass or polycarbonate is installed.

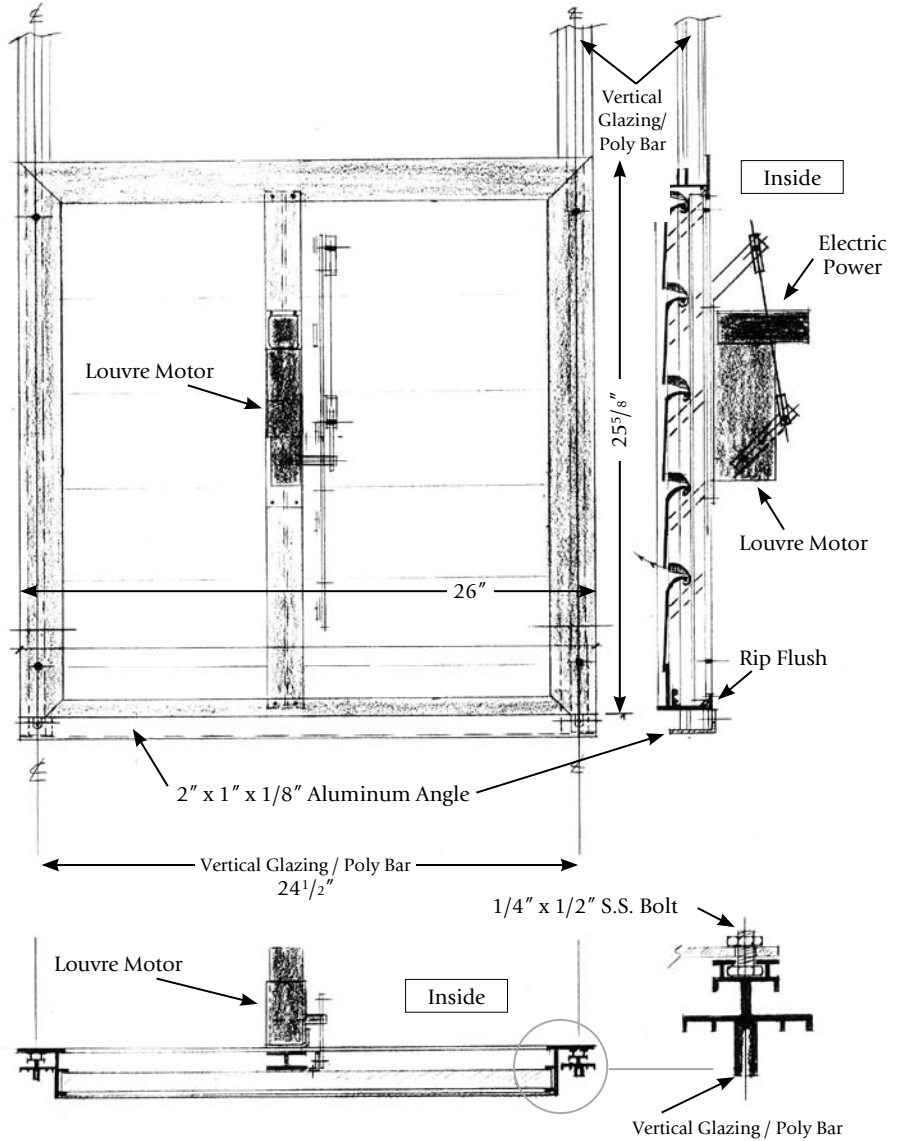

Inside View



# Appendix C – Exhaust Fans

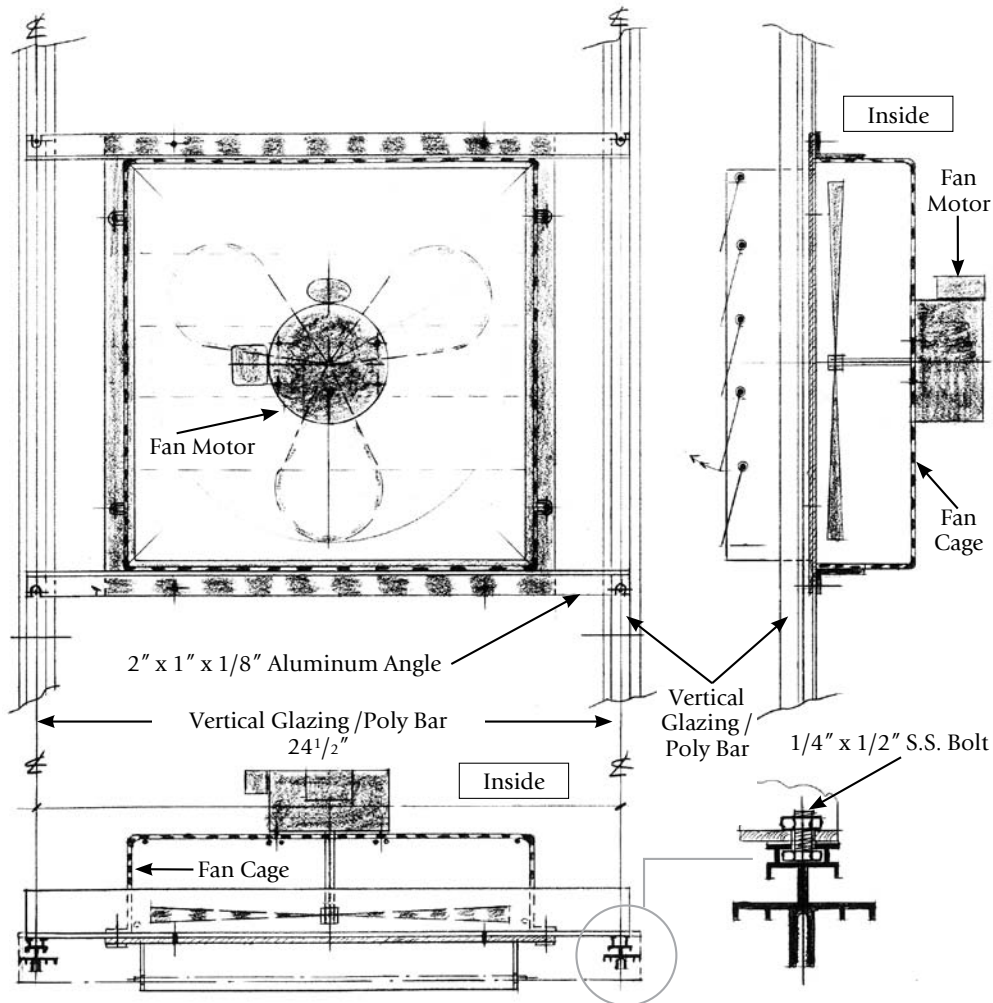

- Slide bolts into vertical bars beside fan bottom.
- Temporarily tighten.
- Insert fan in square cutout of acrylic piece.
- Slide bolts into slots on angle and tighten
- Seal around shutter on outside.

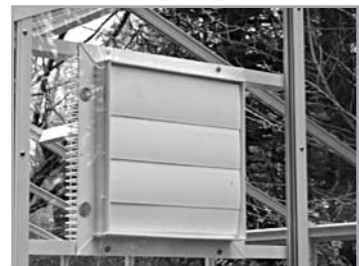

# Appendix D – Side Vent

## GLASS SIDE VENT ASSEMBLY

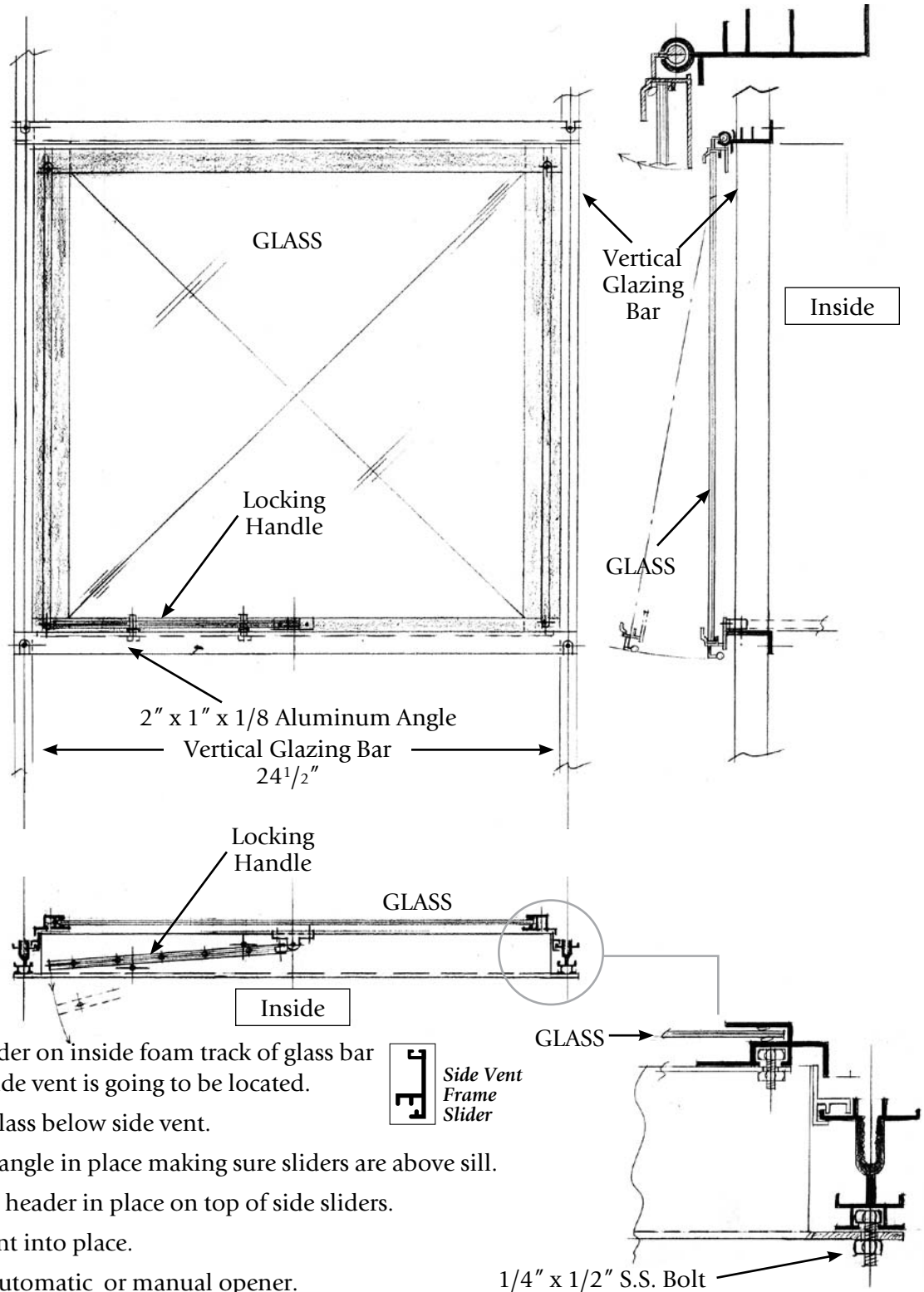

1. Slide slider on inside foam track of glass bar where side vent is going to be located.
2. Install glass below side vent.
3. Bolt on angle in place making sure sliders are above sill.
4. Bolt top header in place on top of side sliders.
5. Slide vent into place.
6. Install automatic or manual opener.

# Appendix D – Side Vent CONTINUED

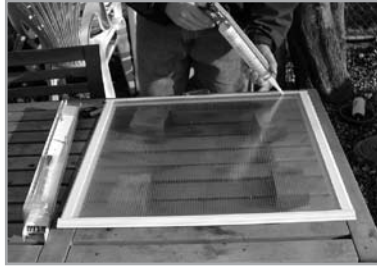
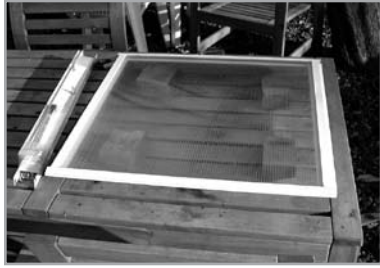

# Appendix E – Glass Louvre

## GLASS OR POLYCARBONATE GLASS LOUVRE ASSEMBLY





# Appendix F – Perlin Installation

Larger greenhouses have perlins to increase strenght in roof structures. A perlin can be a heavy or light channel. It usually sits on top of a truss and is bolted to the roofbars in the centre of he roof.

Heavy perlin (at least 1/4" thick) requires 1/4" x 3/4" bolts. Smaller greenhouses use a light channel – bolts used are the same as the greenhouse bolts, 1/4" x 1/2."

Installation of a perlin is a simple matter of sliding the bolts into the roof bars and feasting the perlin (see photos).

Bolt Perlin with the open side facing up if you wish to use it for hanging baskets.

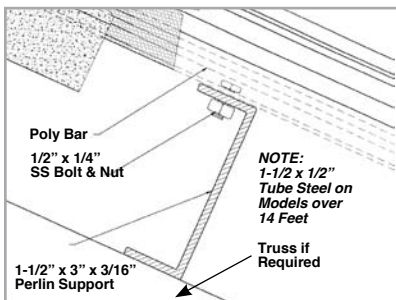
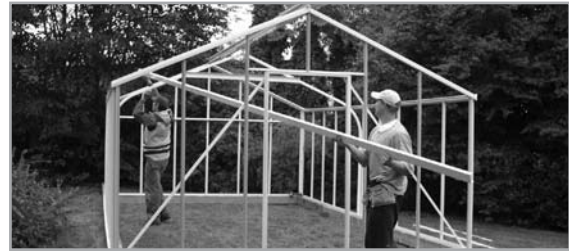
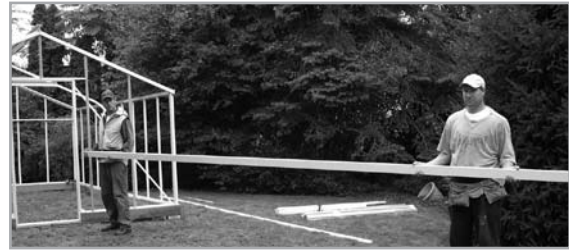

# Appendix G – Greenhouse Bench

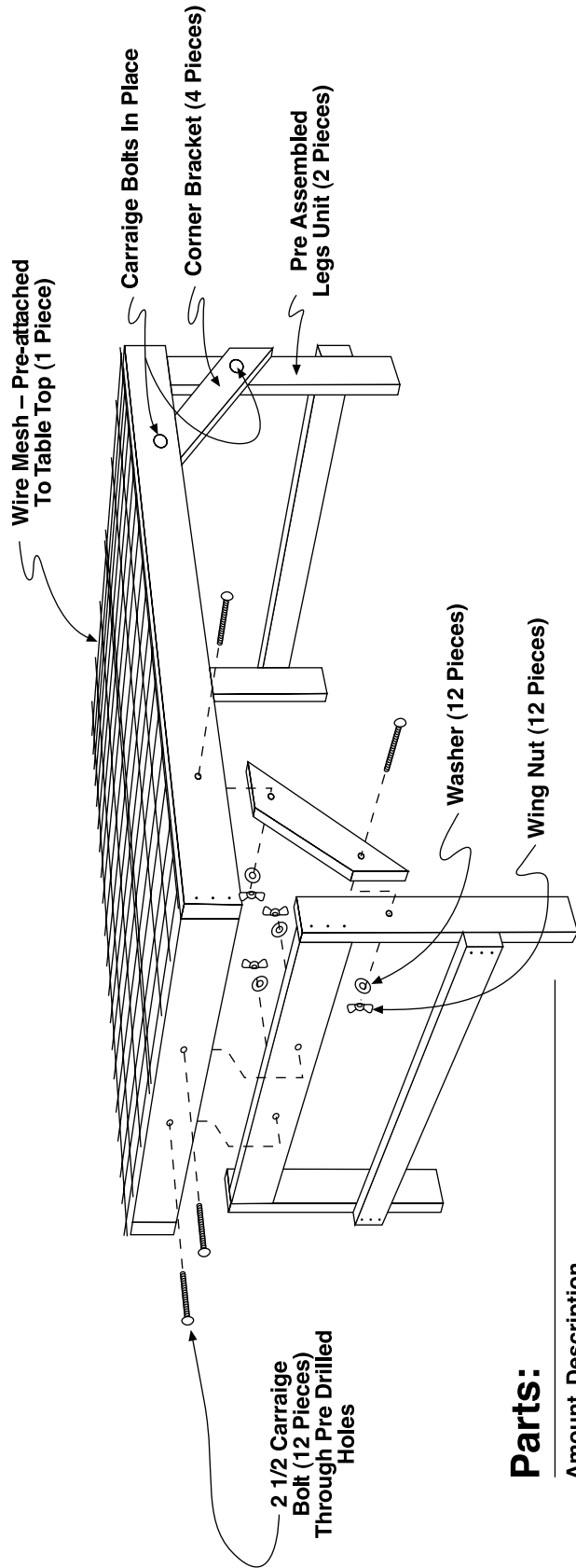

## Parts:

Amount	Description
1	Table Top = W/ Pre-attached Wire Mesh Plastic Coated W/Guide Holes
2	Leg Units = Pre-assembled W/ Guide Holes
4	Corner Brackets = W/ Guide Holes
1 Bag	Contains: 12 – 2 1/2 Carrage Bolts 12 – Washers 12 – Wing Nuts

# Appendix H – Roof Vent Screen

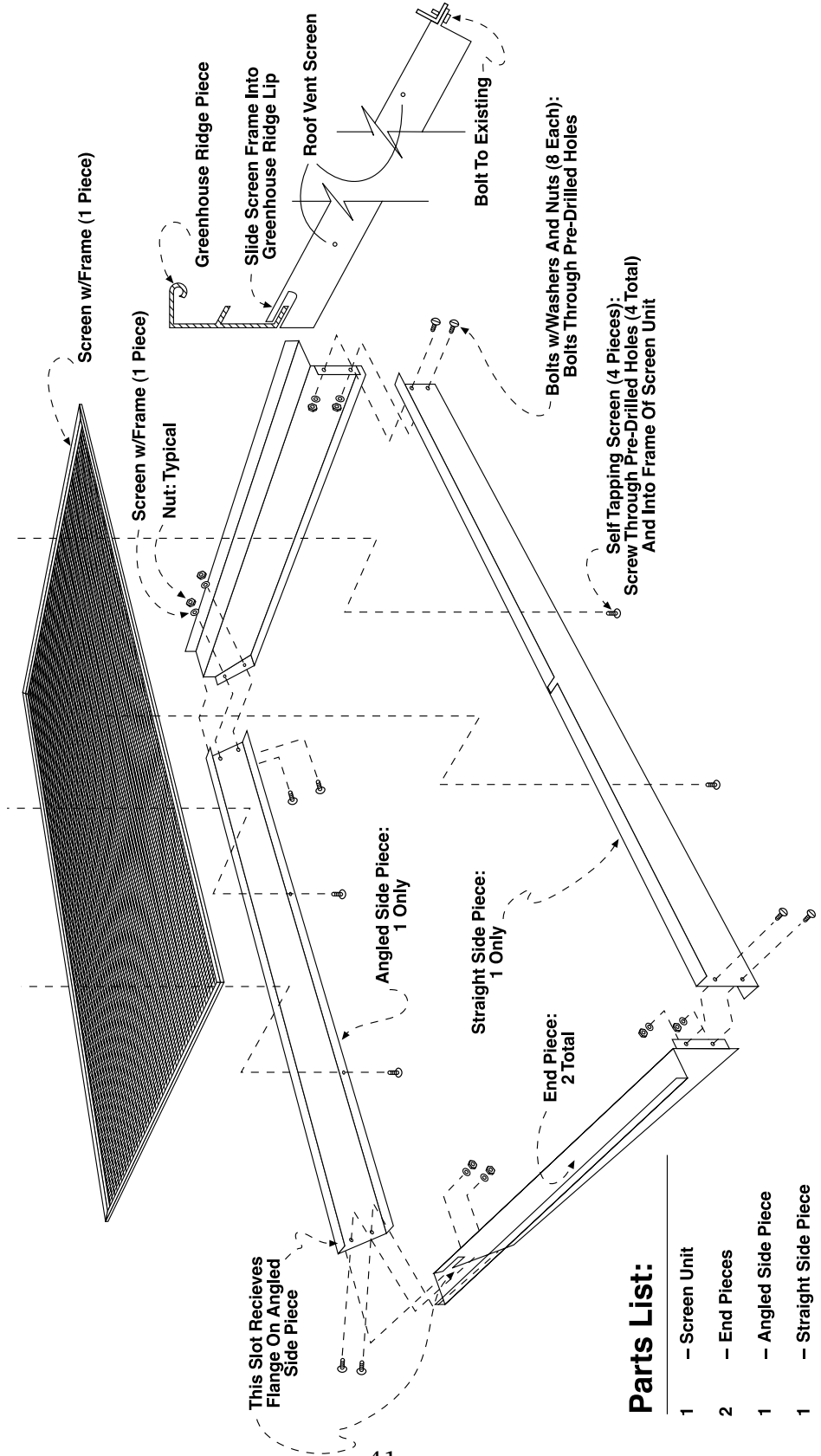

## Parts List:

- 1 – Screen Unit
- 2 – End Pieces
- 1 – Angled Side Piece
- 1 – Straight Side Piece
- 1 Bag With:
  - 8 – Bolts
  - 8 – Washers
  - 8 – Nuts
  - 4 – Self Tapping Screws

# Appendix I – Side Vent Screen

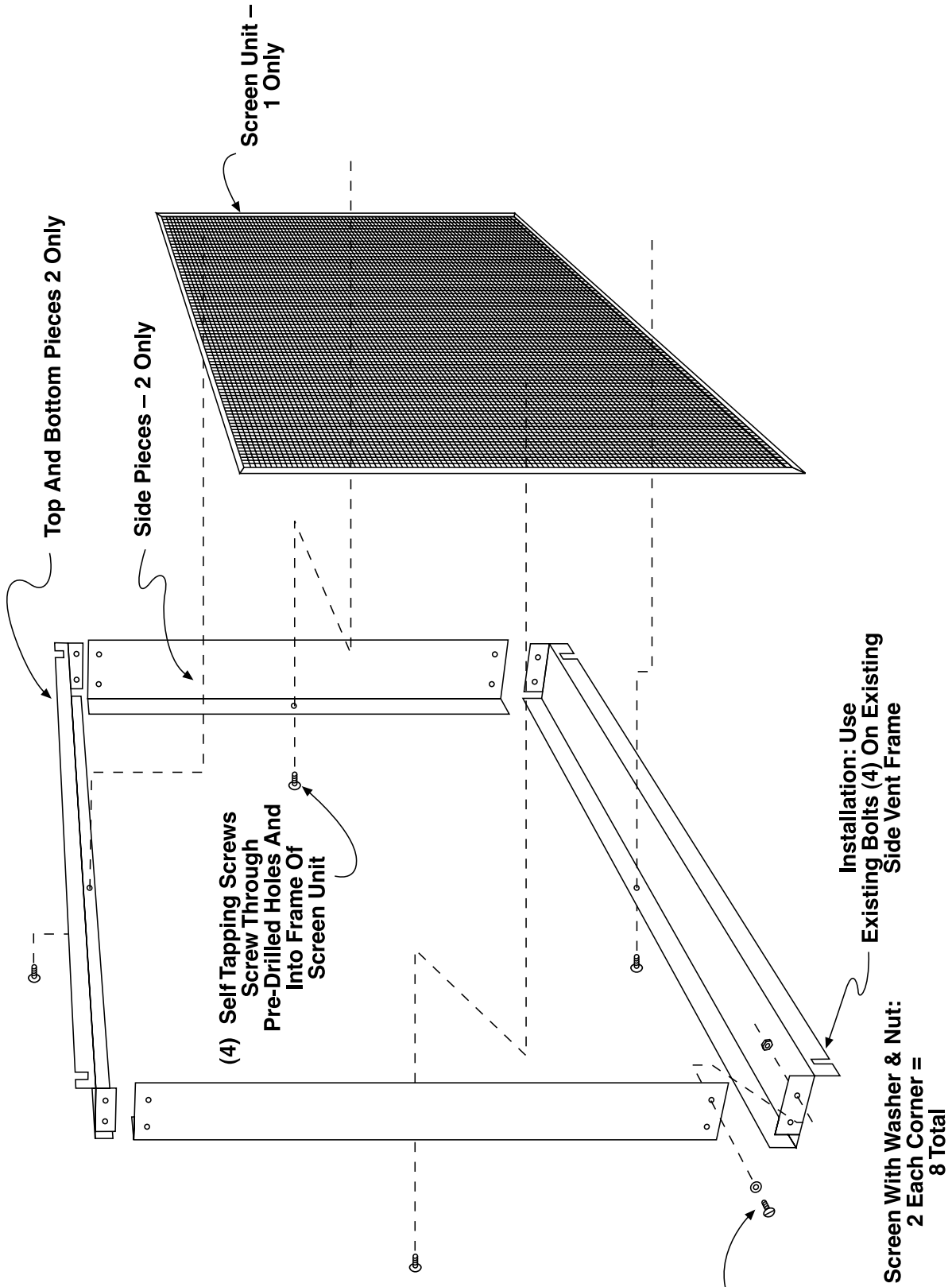

# Appendix J – Wire Shelving

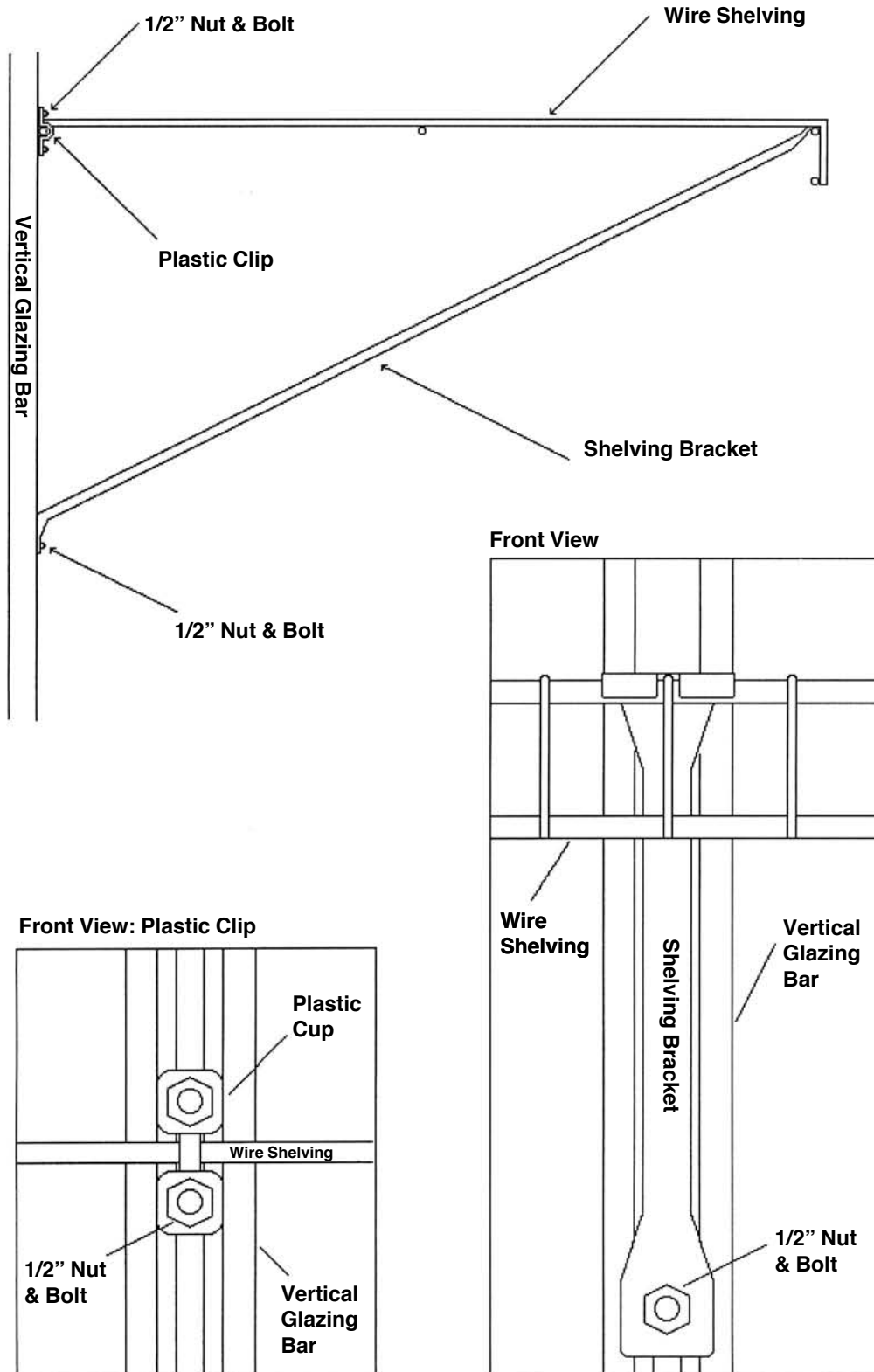

# Miscellaneous Assembly Details – 1

## VENT FRAME 3D VIEW

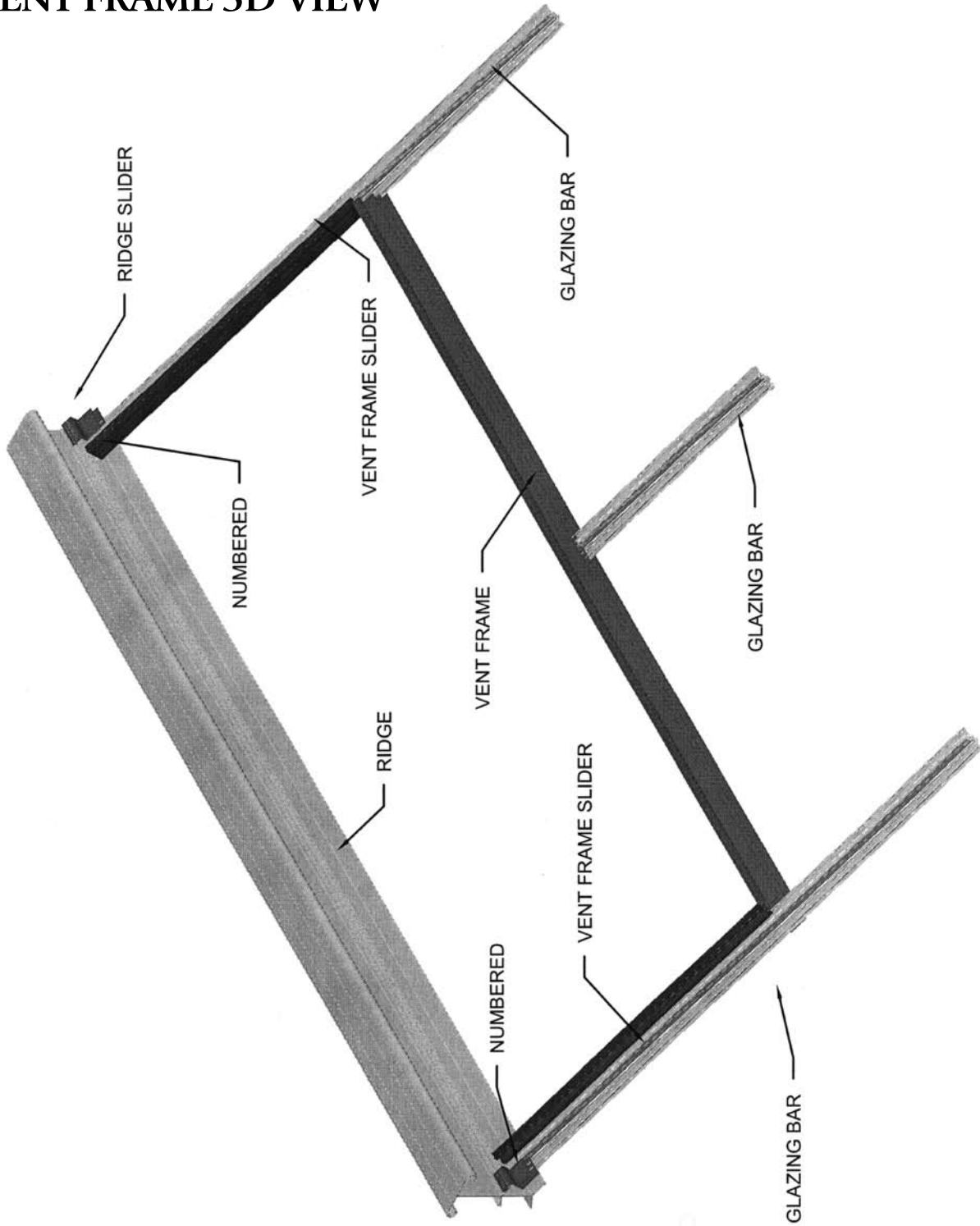

# Miscellaneous Assembly Details – 2

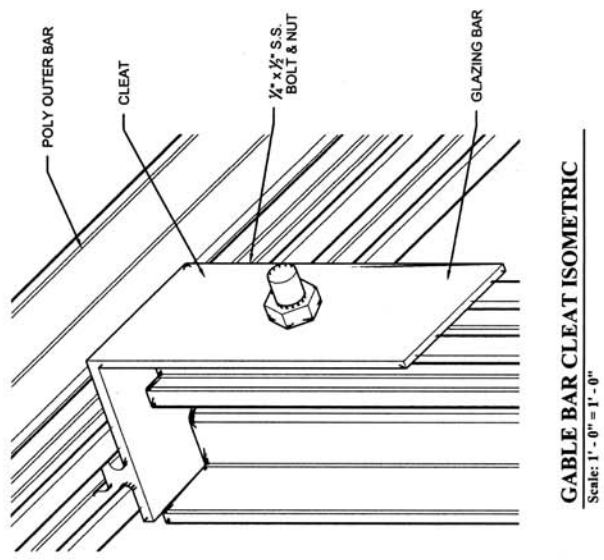
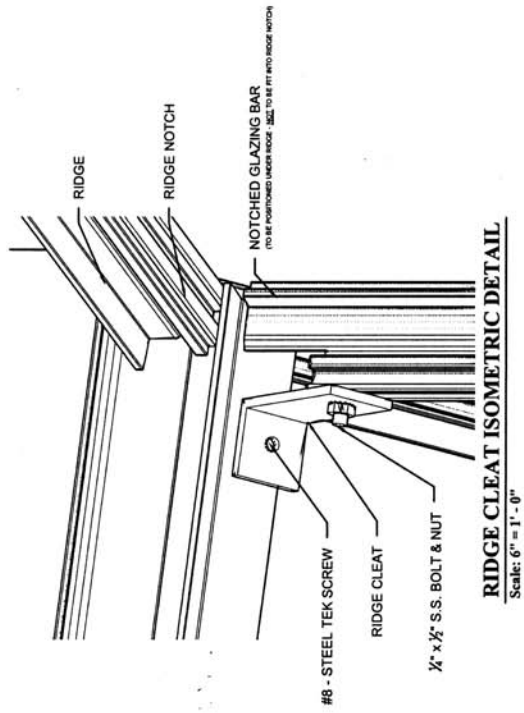
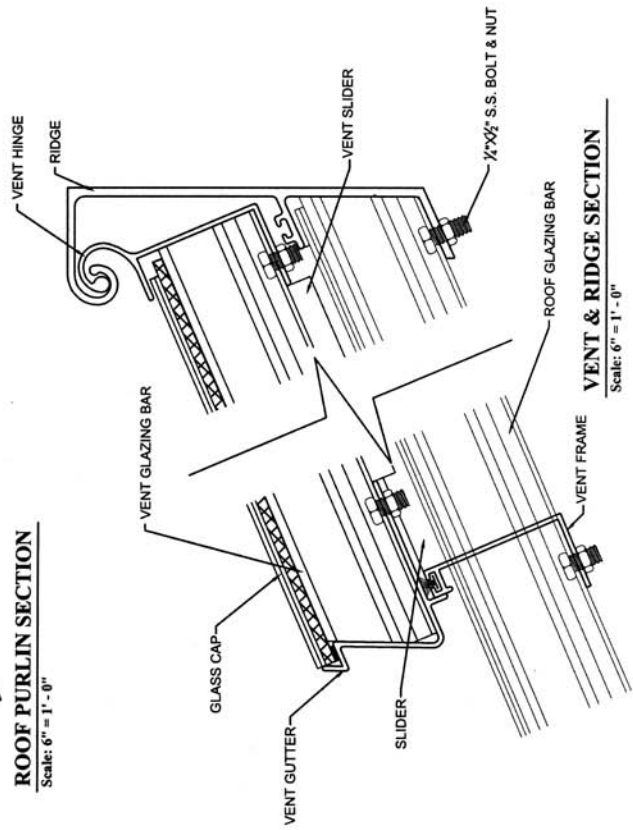
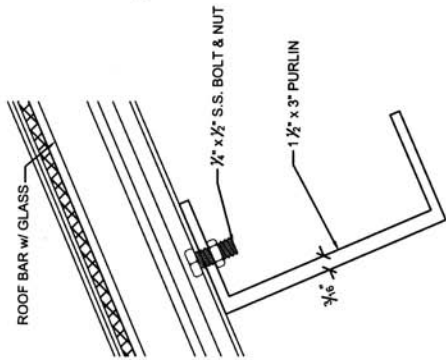
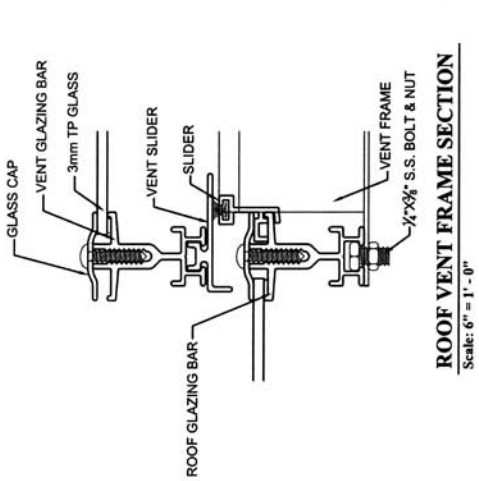

# Miscellaneous Assembly Details – 3

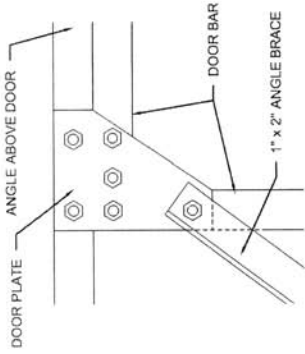

**ANGLED DOOR BRACE**  
Scale: 3\"/>

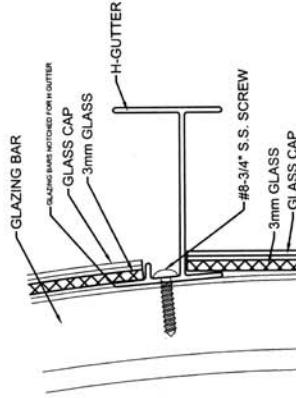

**H-GUTTER DETAIL**  
Scale: 6\"/>

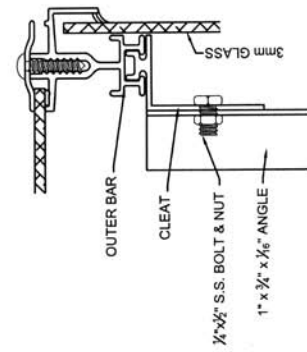

**CORNER CLEAT DETAIL**  
Scale: 6\"/>

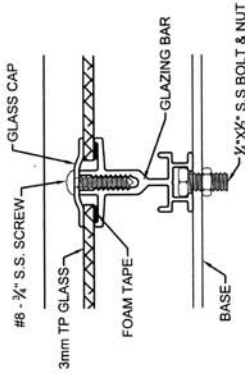

**GLAZING BAR**  
Scale: 6\"/>

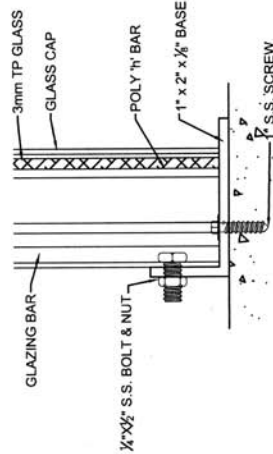

**GABLE BASE SECTION**  
Scale: 6\"/>

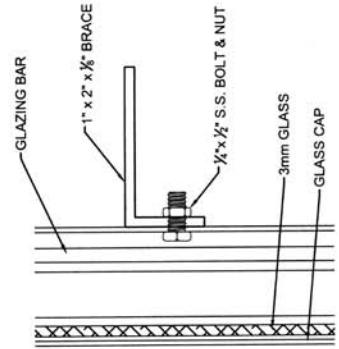

**HORIZONTAL BRACE SECTION**  
Scale: 6\"/>

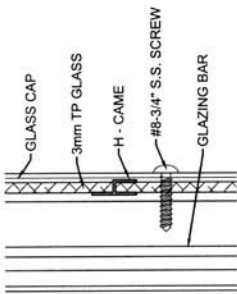

**H-CAME SECTION**  
Scale: 6\"/>

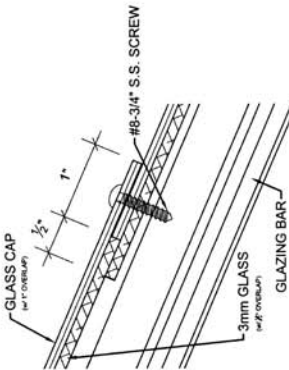

**GLASS OVERLAP DETAIL**  
Scale: 6\"/>

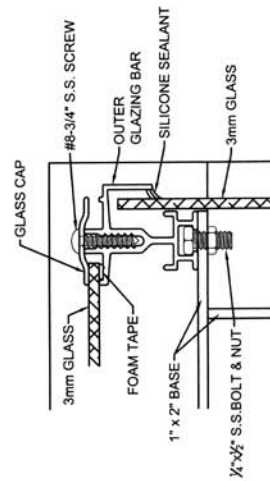

**CORNER DETAIL**  
Scale: 6\"/>



# Miscellaneous Assembly Details – 4

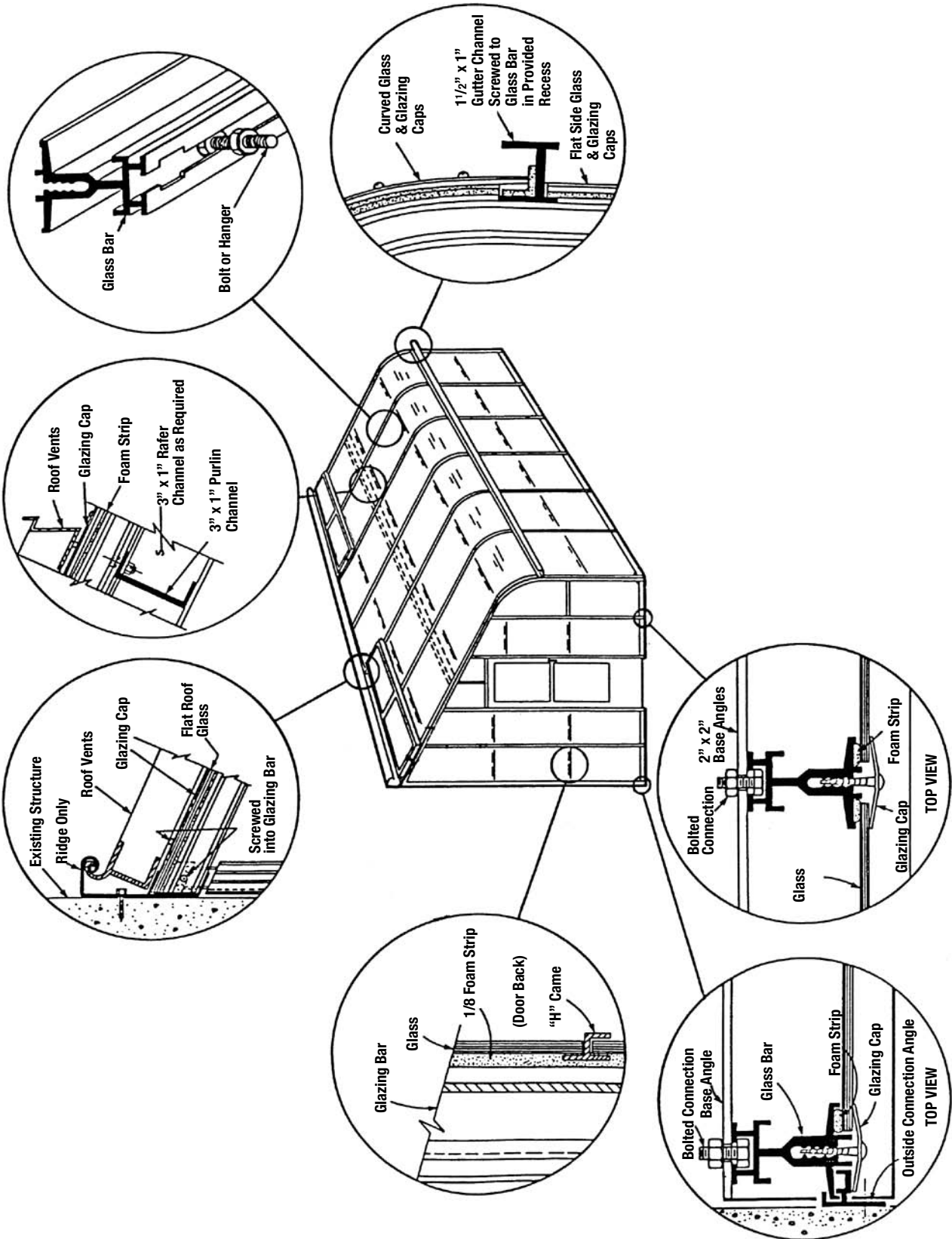



*At this point, stand back and enjoy your workmanship.*

*Your Pride of the Pacific Lean To Greenhouse  
should now be closed in and ready for use.*

*Congratulations!*