

Cross Country Series Curved Lean To

Model PLT612TW

GREENHOUSE INSTRUCTIONS

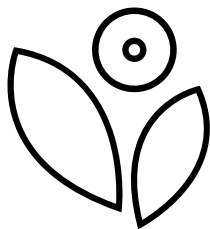

Greenhouse Style
CORPORATION

Telephone: 1-800-665-2124 | Fax: 1-888-273-1251

www.greenhousetyle.com • info@greenhousetyle.com

Contents

Foreword	2
User Notes	2
List of Drawings	3
Cross Country Curved Lean To Series Component List	4
Foundations	5
Assembly of the Aluminum Frame	
A. Back Gable-End Assembly	6
B. Front Gable-End Assembly with Door	8
C. Taping Poly Bar with Foam	11
Aluminum Frame Installation	
1. Side Base / Sill	12
2. Side Base / Sill To Front Gable-End	12
3. Side Base / Sill to Back Gable-End	12
4. Ridge	12
4A. Truss Assembly Installation (If Necessary)	See Appendix A
5. Poly Bar With Sliders (#1 or #2)	12
6. Vent Frame Angle	13
7. Side / Roof Poly Bars	13
8. Roof Purlin	13
9. Taping Poly Bars with Foam	13
10. Fastening & Sealing Greenhouse	13
11. Side Vents, Intake Shutter and Exhaust Fan Installation (if necessary).	See Appendices B through G
Polycarbonate and Cap Installation	
General Information About Handling Polycarbonate	20
12. Roof Polycarbonate Panel Installation	21
13. Back/Front Gable-Ends	22
14. Sealing The Greenhouse	23
Door And Vent Installation	
15. Door Installation	24
16. Vent Assembly	26
17. Vent Installation	26
Appendices: Optional Installations	
Truss	Appendix A
Intake Shutter	Appendix B
Exhaust Fan	Appendix C
Side Vent	Appendix D
Glass Louvre	Appendix E
Roof Vent Screen	Appendix F
Side Vent Screen	Appendix G
Wire Shelving	Appendix H

Foreword

Your Cross Country greenhouse is designed and constructed to the highest engineering standards and provides structural strength and maintenance-free service for year-round gardening pleasure.

The Cross Country greenhouse must be built upon a firm, level surface. The greenhouse foundation or sill can be made from pre-treated timbers, concrete or bricks. Whatever your choice of material, the base must be square and level.

When selecting a site for your greenhouse, keep in mind that a flat, level site is essential so that the greenhouse can be easily installed and the complete structure is stable and secure. If possible, choose a site with proper water drainage.

Locating the greenhouse in a north-south position is most suitable for raising summer and autumn crops since the sun's rays will be on the greenhouse from daybreak until sunset. An east-west position is ideal for early spring and winter crops since the winter months, with shorter daylight hours, still allow six hours of light exposure to the greenhouse.

Try to locate your greenhouse for easy access, especially to the necessary power and water that is required for greenhouse gardening.

Please watch the enclosed video and follow the steps in this manual for your greenhouse installation. *Remember, if all else fails, read the instructions.*

User Notes

The Cross Country greenhouse structure has been designed to withstand extreme weather conditions such as high winds and accumulated snowfall. Hanging baskets and sidewall shelving can also be attached to its sturdy frame. The greenhouse design also makes it possible to add extra sections at a later date.

Sealing the polycarbonate sheets to the aluminum "H" and base is optional, however we highly recommend it.

Eliminating any water from entering the inside of the aluminum, will prevent excessive moisture inside the panels.

Once a year the greenhouse needs to be completely washed inside and out. You should do this task when your greenhouse contains the least number of plants, generally just before the garden plants are brought in for wintering over. A recommended cleaning solution is a mixture of soap and water, this will not damage your polycarbonate sheets. Any benches, shelving, plastic trays, pots and baskets should also be cleaned thoroughly. *Prevention is the best known method for controlling pests and diseases in the greenhouse.*

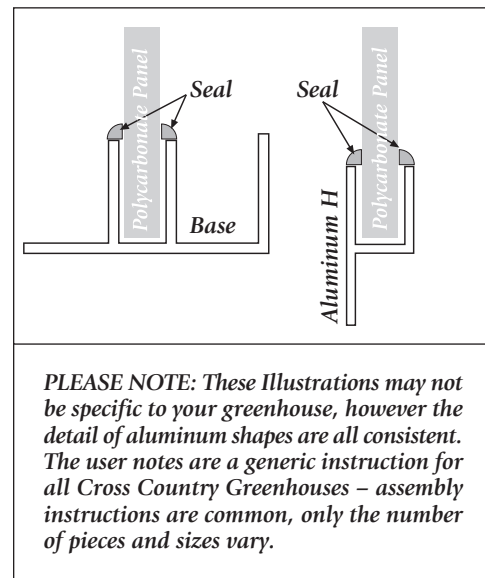

NOTE: DO NOT STORE POLYCARBONATE SHEETS IN THE SUN.

List of Drawings

Cross Country Curved Lean To Component List	4
Foundation Styles	5
Back Gable End Line Drawing Assembly Procedure	6
Back Gable End Detail Drawing – <i>Details 1 – 4</i>	7
Front Gable End (With Door) Line Drawing Assembly Procedure	9
Front Gable End (With Door) Detail Drawing – <i>Details 5 – 10</i>	10
Assembly Outline: Aluminum Frame Steps 1 – 10	14 - 19
Polycarbonate Installation Steps 12 – 14	20 - 22
Door Installation	25
Vent Assembly - Exploded View	27
Truss Assembly	Appendix A
Intake Shutter	Appendix B
Exhaust Fan	Appendix C
Side Vent	Appendix D
Glass Louvre	Appendix E
Roof Vent Screen	Appendix F
Side Vent Screen	Appendix G
Wire Shelving	Appendix H

Cross Country Component List

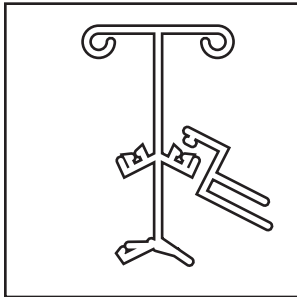

Ridge & Ridge Slider

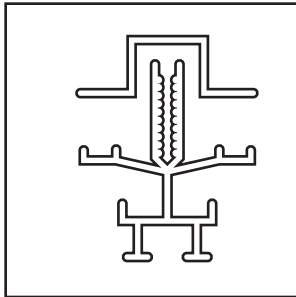

Poly Cap & Poly Bar

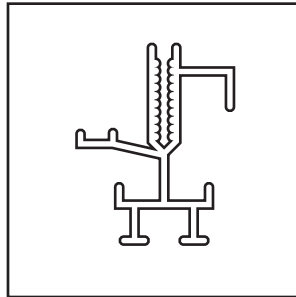

Poly End Bar

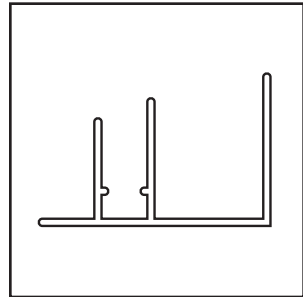

Side Base/Sill

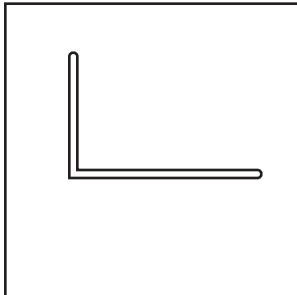

Bracing Angle

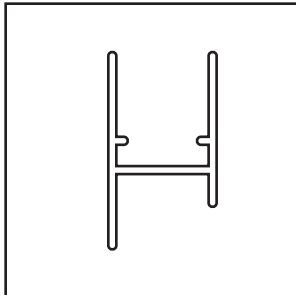

Aluminum H

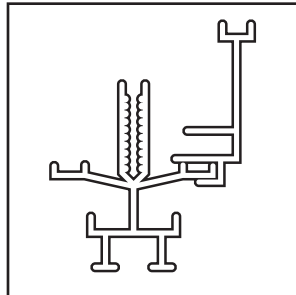

Vent Frame Sides

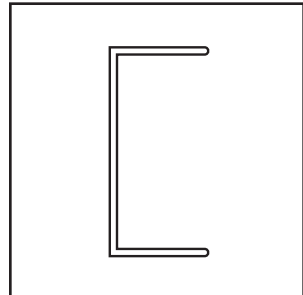

Perlin



Bolts / Nuts / Screws

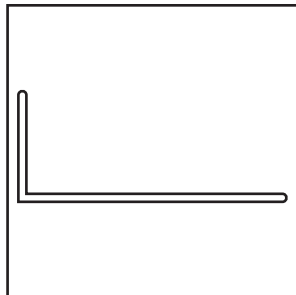

Front & Back Base/Sill

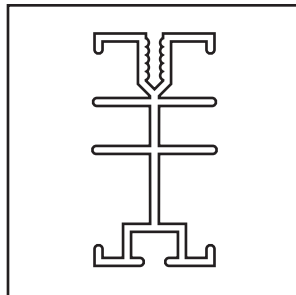

Door Frame

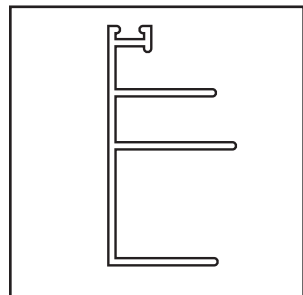

Ventframe Bottom

Tools

- #2 Square head screw driver (#8 Screw)
- Measuring tape
- Level to check foundation
- 3/16" concrete bit (concrete foundation)
- 9/64" aluminum bit
- 7/16" wrench
- Razor blade cutter
- Caulking gun
- Ladder
- Hammer

Optionals

- Automatic Opener
- Circulating Fan
- Max/Min thermometer
- Benches
- Eyebolts
- Motorized Intake Shutter
- Exhaust Fan
- Thermostat
- Heater
- Side Vent

'New' Pressure Treated Wood

WHAT IS NEW ABOUT PRESSURE TREATED WOOD?

As of January 2005, the chemicals used in pressure treated wood have been changed. Previous wood was treated with arsenic. However due to the potential long term health hazards this has been discontinued. New pressure treated wood is treated with copper.

The copper in the 'new' wood will be CORROSIVE TO ALUMINUM as well as other metals.

What are 'Greenhouse Friendly' solutions to the new pressure treated wood?

- 1 If you are using the new pressure treated wood, you must place a barrier between the wood and your aluminum frame. Popular barriers include 10 mil thick plastic sheeting, steel weather flashing, a rubber or foam weather membrane, or a row of weather resistant non-treated wood such as cedar or hemlock.
- 2 Other weather resistant non-treated woods are popular alternatives to pressure treated wood. These contain no harmful chemicals and will outlast pressure treated wood. Cedar timbers are a popular choice for greenhouse foundations.
- 3 Concrete foundations have always been suitable foundation alternatives for greenhouses. They can vary from poured concrete slabs, poured concrete perimeter walls to concrete block walls. Although these are usually more costly than wood alternatives, they have the benefit of lasting a lifetime. As they are usually considered a permanent foundation, it is important to check with your building codes to determine what you are able to build.

If you have any questions about using the 'New' pressure treated wood in conjunction with our aluminum greenhouses, please contact our office at 1-888-391-4433.

Assembly of Aluminum Frame

A. BACK GABLE-END ASSEMBLY

Lay out the back pieces into the shape of the end wall. *Refer to the line/detail drawing.*

1. For the curved Poly End Bars, the flat surface should lie on the ground (See the example to the right. Use the curved end bars with angle sliders attached to it and 1-straight one on the side, see sketch **1A**).
2. Bolt the Poly Bars on the top first (See Detail #1 & 1A, Page 7).
3. Bolt the base/sill to the bottom of the Poly Bars (See Detail #2, Page 7).
4. The angle brace is bolted approximately 56" from the base. The slider brackets that have already been fastened to the poly end bar curve will determine the height (See Detail #3, Page 7). When bolting the horizontal cross brace onto the back wall, measure the back wall so that it does not sag (See Detail #4, Page 7).

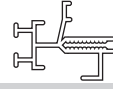

GROUND

Back Gable-End Line Drawing Assembly Procedure

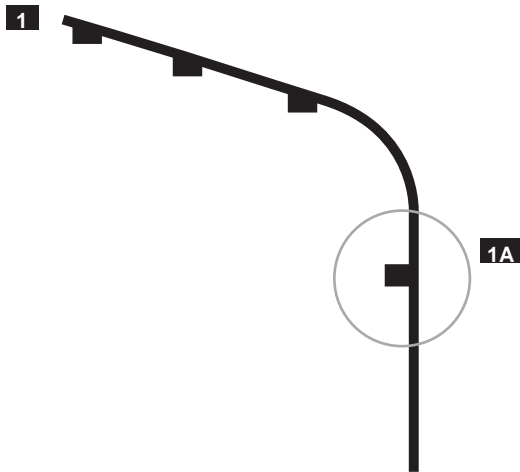

Curved Poly End Bars

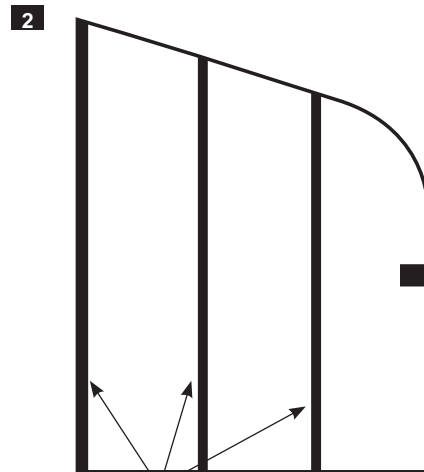

Poly Bars

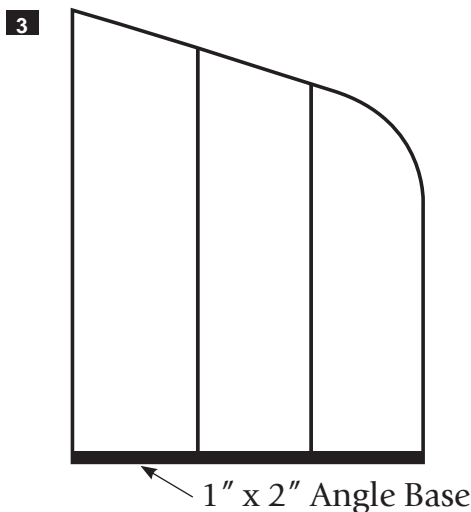

1" x 2" Angle Base

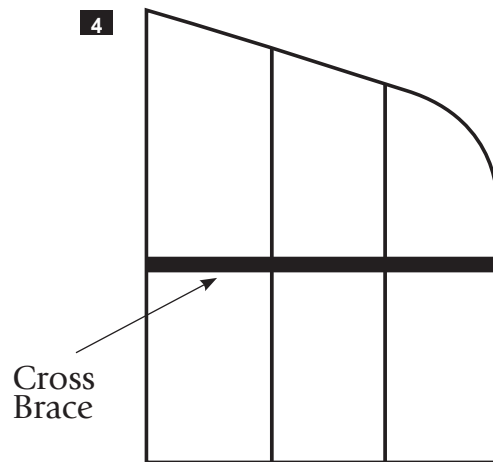

Cross Brace

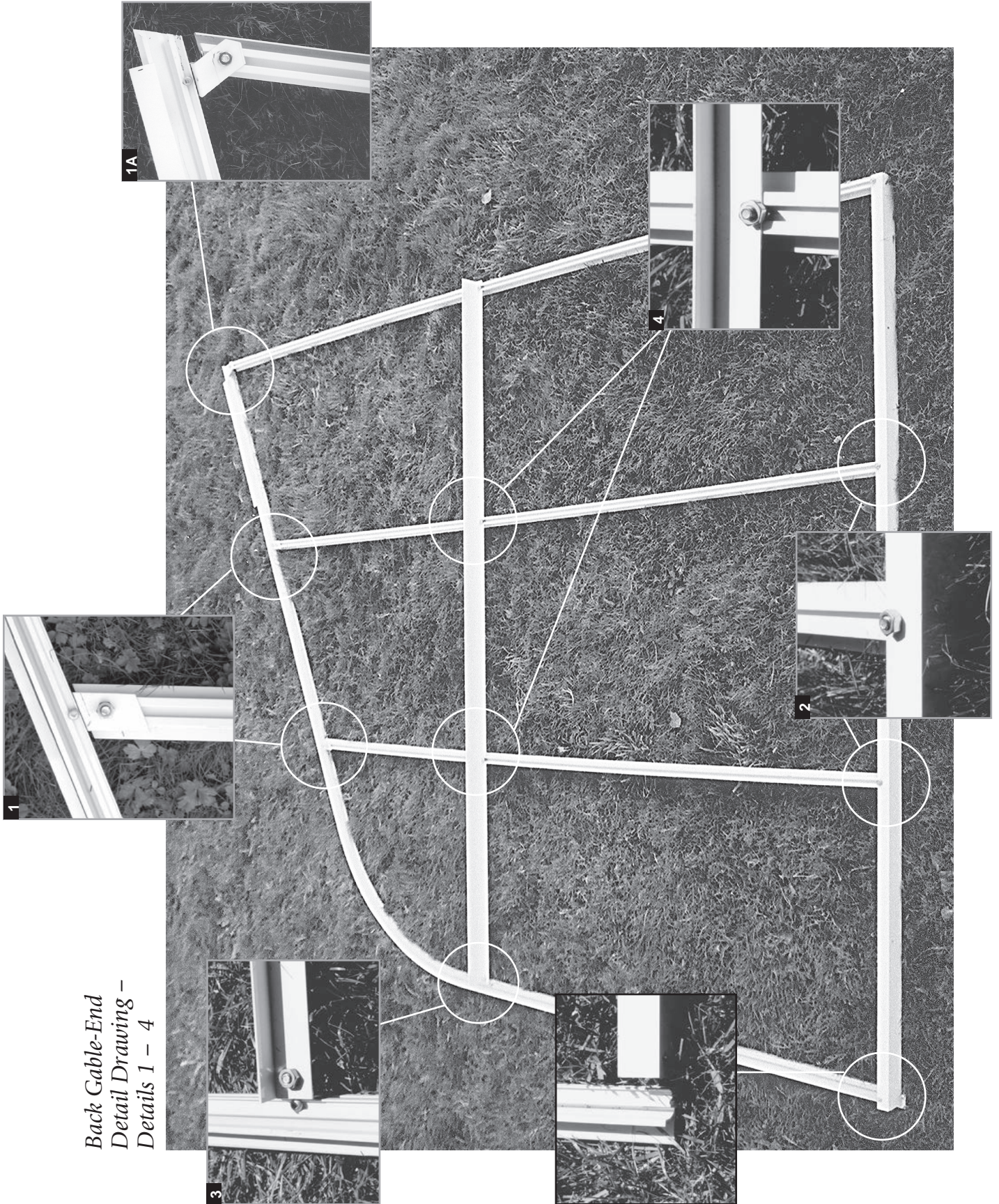

*Back Gable-End
Detail Drawing –
Details 1 – 4*

B. FRONT GABLE END ASSEMBLY WITH DOOR

1. Lay out the front pieces of the greenhouse into the shape of an end wall. The door frame and all the Poly Bars have a track for the bolt. The track must face up when you assemble the gable ends. Slide the bolts into the track of the bars or use the notches that have already been punched out in the bars. *(Refer to the line/detail drawing on the following page. The order of assembly is represented by dark lines. Detailed pictures are on page 10.)* When you are assembling the greenhouse, you view the sketches and drawings from the inside the greenhouse. Bolt the bottom plates (4 holes) to the base/sill and the door frame sides using 1/4" x 1/2" stainless steel bolts *(see Detail #5)*. Before tightening the bolts, be sure that it is square (If you ordered a greenhouse with a door drop, measure from the bottom of the door frame to the underside of the base according to the specified distance).
2. At the top of the door frame, put on the door frame header (which looks the same as the side pieces). Put the header between the two side pieces and bolt on the plates (6 holes). *(See Detail #6)*. The plates should stick up 1" above the door frame. Note how the plates are put on *(See Detail #7)*. Before tightening the bolts, be sure to square up the sill to the door frame.
3. Take all the Poly Bars and bolt them to the base/sill. The angle cut should match the roof slope *(See Detail #8)*.
4. The 1" x 2" angle above the door (50" long) can now be bolted on. The 1/4" round holes should be lined up with the holes in the plates. Each end of the 1" x 2" angle has a slot punched out to accommodate the bolt. This slot lines up with the bolt track in the back side of the Poly Bars. Slide a bolt in the top of the Poly Bar and fasten the angle to it *(See Detail #6 & 9)*.
5. **Curved Roof Poly End Bar.** Each curved Poly End Bar has at least two small aluminum brackets attached to it with a 1/4" hole drilled in it. These pieces line up with the upright Poly Bar(s) *(See Detail #8 & #9)*
6. When the upright Poly Bars are fastened to the aluminum bracket that is attached to the poly end bar, bolt on the short Poly Bar above the door to the 1" x 2" angle.
7. The diagonal bracing can now be bolted on. Remove the bottom nut in the top plate and insert the brace. Then put the nut back on *(See Detail #4)*. Bolt the other end to the 1/4" hole in the base using a 1/4" x 1/2" bolt *(See Detail #10)*.

NOTE: *You may want to fasten a temporary brace across the bottom of the door frame to keep them together. This can be a piece of wood, make sure that the opening is the same as on the top of the door frame.*

Front Gable-End (with door) Line Drawing Assembly Procedure

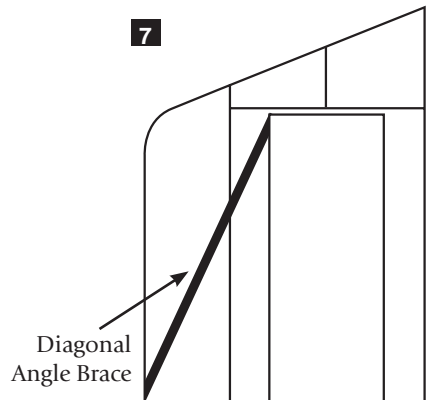
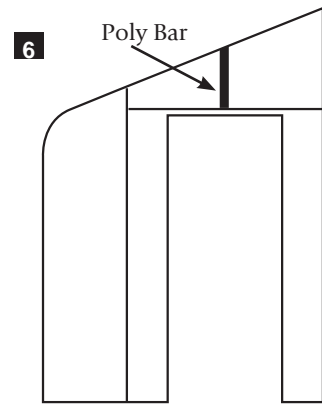
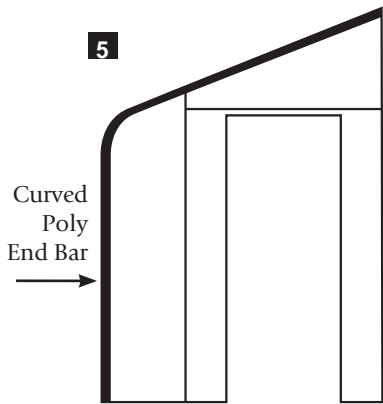
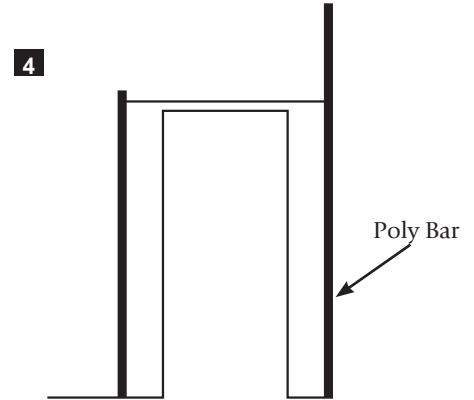
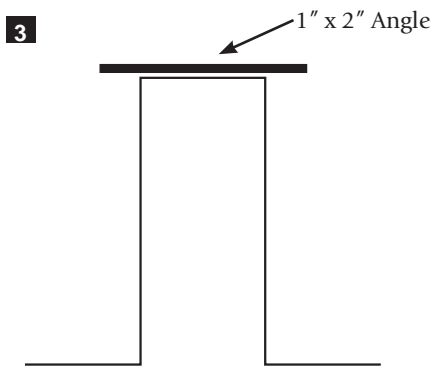
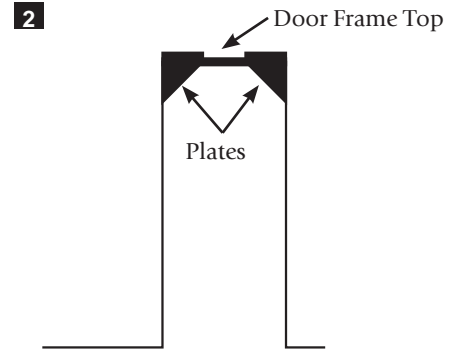
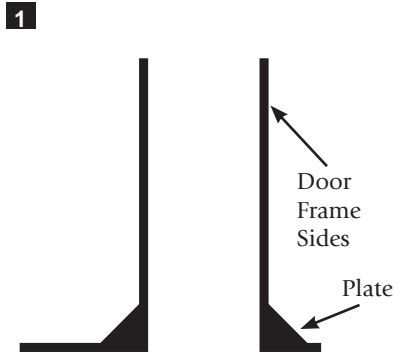

Front Gable-End (with door)
Detail Drawings
Details 5 – 10

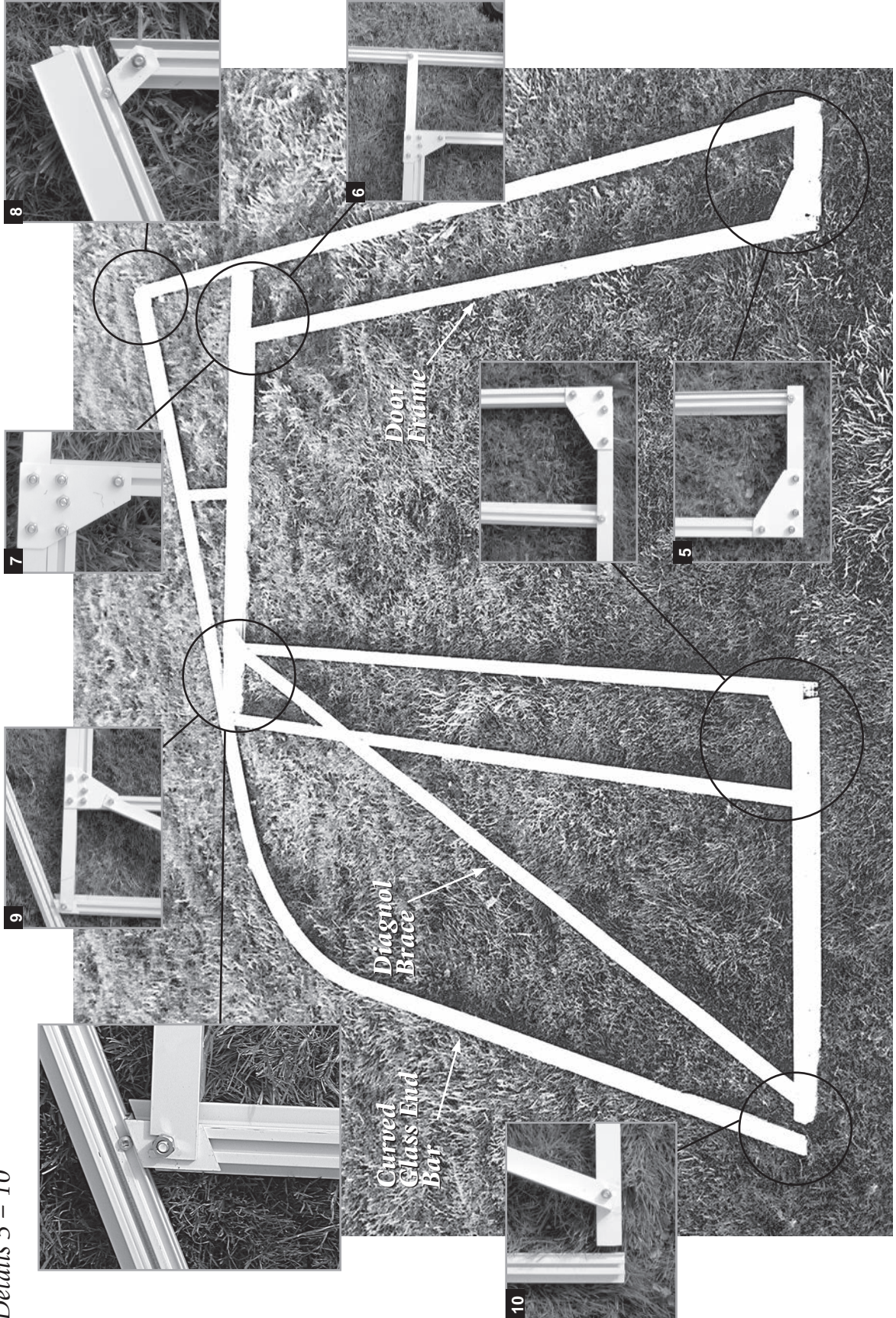

C. TAPING POLY BARS WITH FOAM

Tape all the aluminum poly bars with a 1/8" foam gasket. Tape the poly end bars on one side only (See Detail **14**). Tape all the other poly bars on both sides. Take a roll and, starting at one end, press on the bar. *Make sure that the aluminum is dry.* (You should move all the pieces into a shed or undercover if it is raining). Slowly roll down the tape toward the outer edge and press it down at the same time (See Details **14A** & **14B**). Be careful because sometimes the edge of the paper is quite sharp. Do not remove the paper until later. Do not tape where the poly bar is notched out (See Detail **15**).

NOTES: Taping can also be done either before (as shown in pictures to the right) or after the greenhouse is assembled.

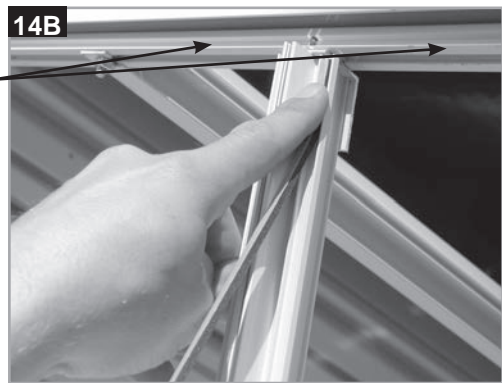
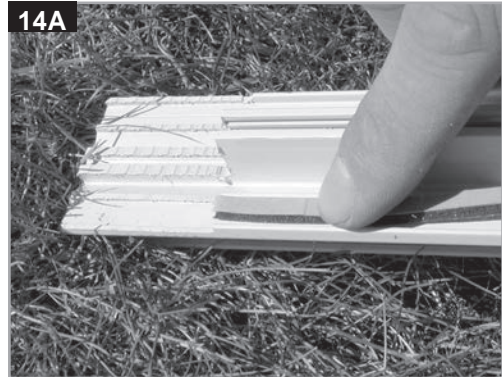
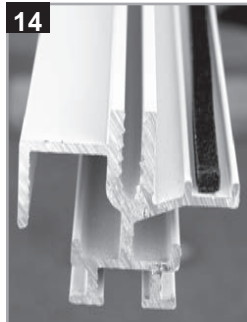
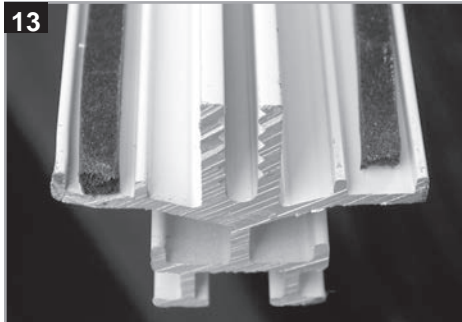

Do NOT put foam tape along the End Bars. The polycarbonate slides under the lip and needs to be sealed when the greenhouse is finished

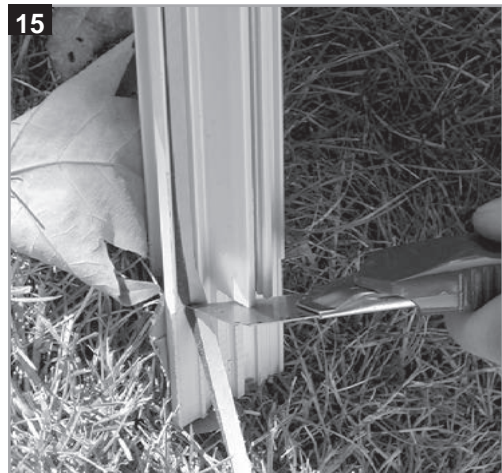
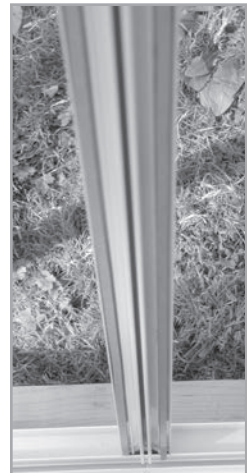

Aluminum Frame Installation

Check that the foundation is level and square. If your foundation is larger than the greenhouse, mark a line on it with a pencil or with a chalk line. Take a caulking gun and put in a tube of caulking. Cut 1/4" off the top at a 25-degree angle. Then put a bead of caulking on your foundation approximately 1" in from the outside of the foundation or the marked line. **DO NOT CAULK THE DOOR OPENING.** Measure your door opening in the front.

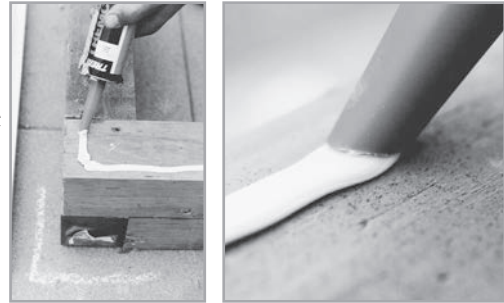

1. SIDE BASE/SILL

Lay down the aluminum side base/sill flush with your base or on the line you have marked out. Push down on it so that the caulking squeezes out. *(See Step 1 Detail, page 14)*

2. FRONT GABLE-END

Stand up the door end, flush with your base or marked line. Slide up one bolt in the bottom of curved glass end bar (front). Take the end bar and push it into the side base where it is notched. The back of the bar lines up with the first slot in the side base/sill. Slide the bolt down and fasten it. When you are lined up and in the right place, screw down the front base/sill using the screw holes that are already there. Then put one screw in the side base to hold it in place. When you have fastened down the front, it should stand by itself. (If it is windy, you will need another person to hold up the front, or you can use a stepladder so that the front can lean against it.) **(NOTE: after the greenhouse frame is up, double check for square and plumb. Seal behind the poly bar, against the wall and the ridge, then put in all the screws.)** *(See Step 2 Detail, page 14)*

3. BACK GABLE-END

Follow the same procedure for the back gable-end as you did for the front. When you have bolted it to the side base and it lines up flush with your base/sill or marked line, then you can proceed. Fasten the base/sill down to your foundation with the screws that are provided. When fastening the side/base sill to the foundation, be sure that the base is straight. *(See Step 3 Detail, page 14)*

4. RIDGE

Before you slide in the ridge, put one bolt in the top of each curved poly end bar. Take the ridge *(one person at each end)* and slide it between the end bars on the top. You will notice the punched-out slots in the bottom flange of the ridge. The slots on the end line up with the bottom side of the poly end bar. Now slide in the ridge and slide the bolt into the ridge slot. Make sure that the curved poly end bar is tight against the ridge – use a 7/16 flat wrench *(at this time you can temporarily fasten the ridge to keep it from moving around)*. *(See Step 4 Detail, page 15)*

4A. SEE APPENDIX A FOR TRUSS ASSEMBLY INSTALLATION FOR GREENHOUSES LONGER THAN 16 FEET.

5. CURVED POLY BARS WITH SLIDERS (1, 2, 3 etc.)

Each Poly Bar (with a vent frame slider) is marked with a number (1, 2, 3 . . .) to correspond with the number on the ridge. Slide the bolt into the top of the Poly Bar and line it up with the slot in the ridge. Move up the bolt and fasten it. Do the same for the bottom of the polybar. Slide in the bolt, lift up the end, and push it into the side base/sill as far as you can. Then bolt it on. Do this for all the Poly Bars with sliders and numbers. The end of the bar should be tight to the base. *(See Step 5 Detail, page 16)*

6. VENTFRAME ANGLE

The ventframe angle is 50" long with the ends cut out to fit between the two Poly Bars with sliders. *The ventframe is the same shape as your base/sill.* Put the head of the bolt into the punch out in the back of the poly bar (24" from the top), slide the bolt up and fasten it to the ventframe on the bar. Make sure that the angle flanges are facing toward the sidewall (down) and that it is pushed up against the side sliders (already on the Poly Bar). Do this for all of them.

(See Step 6 Detail, page 17)

7. SIDE/ROOF POLY BARS

Bolt on all the remaining Poly Bars. Make sure that the top is tight against the ridge.

(See Step 7 Detail, page 18)

8. ROOF PURLIN (CHANNEL)

When installing the roof purlin, mark it out by measuring from the ridge. The roof purlin should be located approximately the center of the roof. Always face the open end of the purlin up towards the ridge so that it can be used for hanging baskets. Every Poly Bar has notches punched out so that the head of the bolts can be inserted and can slide up or down on the bar.

(See Step 9 Detail, page 20)

9. TAPE ALL POLY BARS

Complete all taping with the 1/8" foam tape if it was not done before.

(See photographs, page 11)

10. FASTENING / SEALING THE GREENHOUSE TO THE WALL

Before you seal behind the ridge and end poly bars, square your greenhouse using the 3/4/5 method (see sketch). Sometimes the foundation is level but your wall is not plumb. You may have to decide to pull the greenhouse away from the wall or make your foundation off-level. When your greenhouse is squared up, mark the edge of the ridge on your wall and pull your greenhouse away from the wall and seal behind it. Push the greenhouse back to the wall and fasten it with screws. **NOTE:** Sealing can also be done after greenhouse is finished and before the vents are installed.

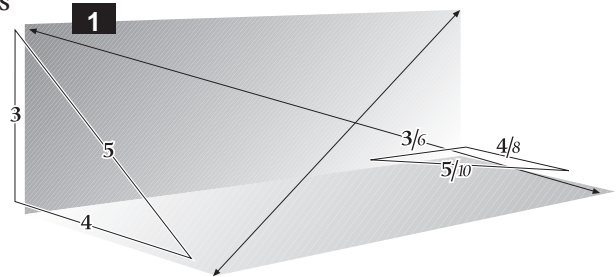

11. SIDE VENTS, INTAKE SHUTTER AND EXHAUST FANS INSTALLATION (IF NECESSARY) SEE APPENDIXES B THRU E. THEN RETURN TO THE NEXT PAGE AND CONTINUE

Assembly Outline

Step 1: Side Sill & Base

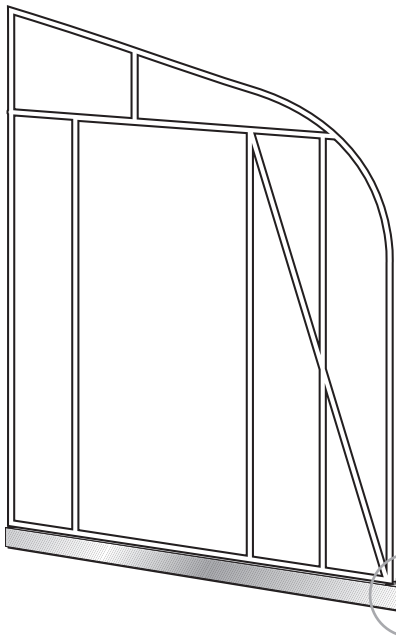
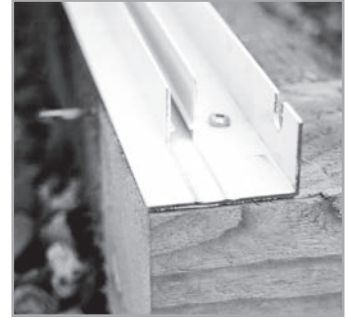
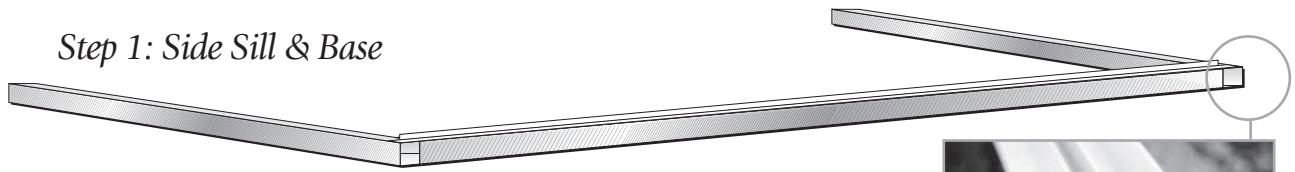

Step 2:
Front
Gable-End

Step 3:
Back
Gable-End

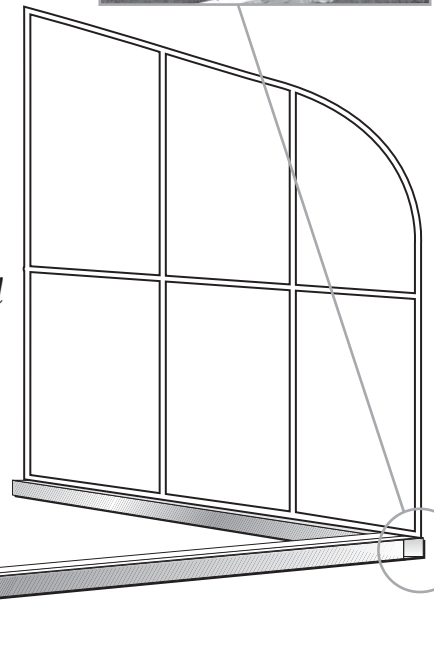

Step 4: Ridge

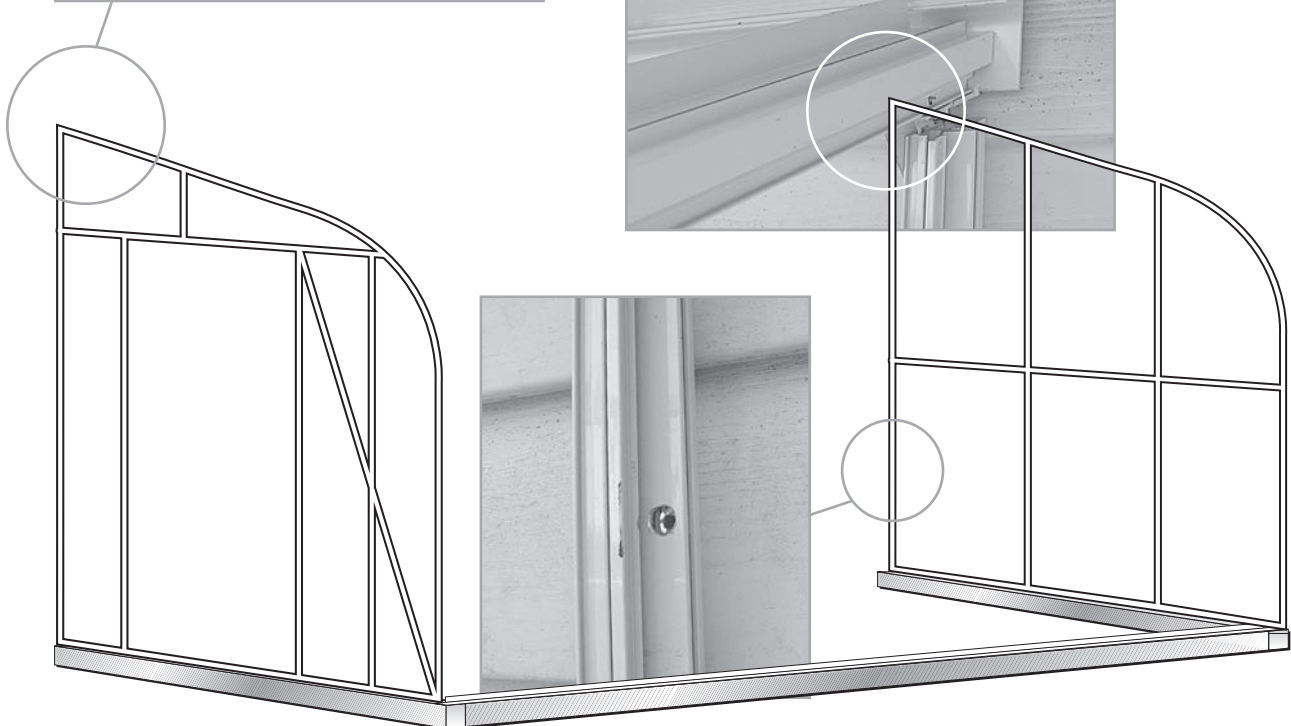
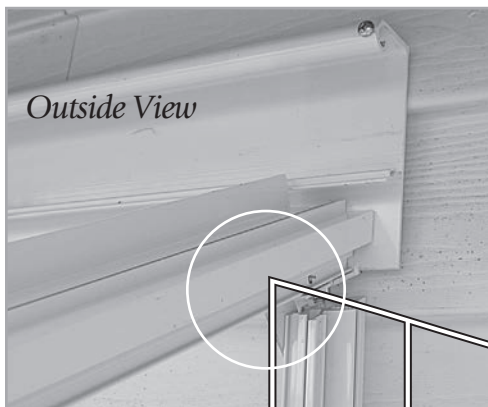
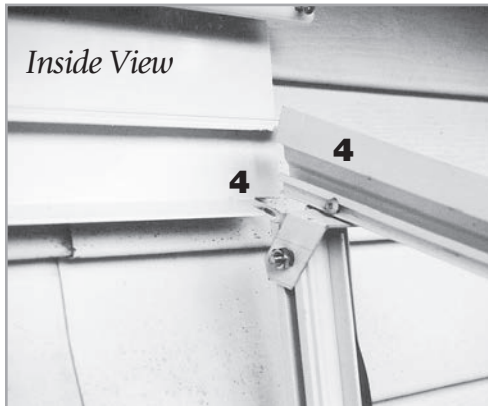

Step 5: Poly Bar with Vent Frame Sliders

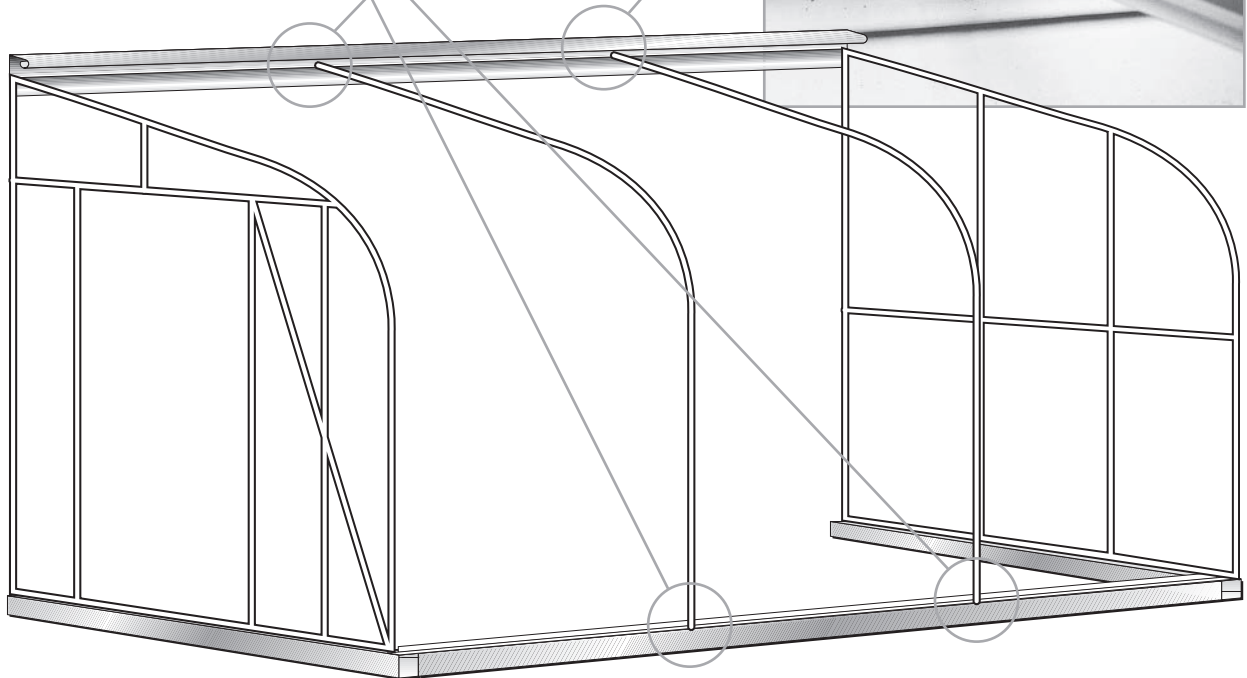
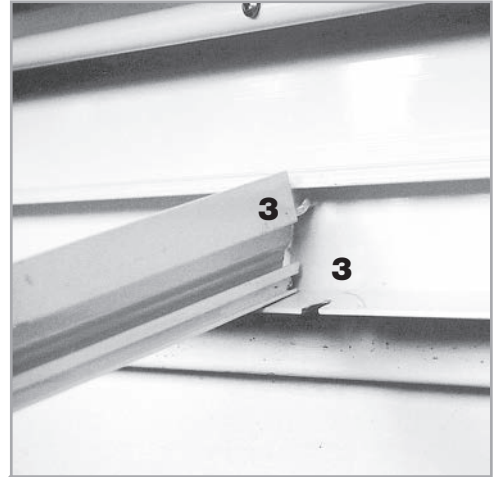

Step 6: Vent Frame

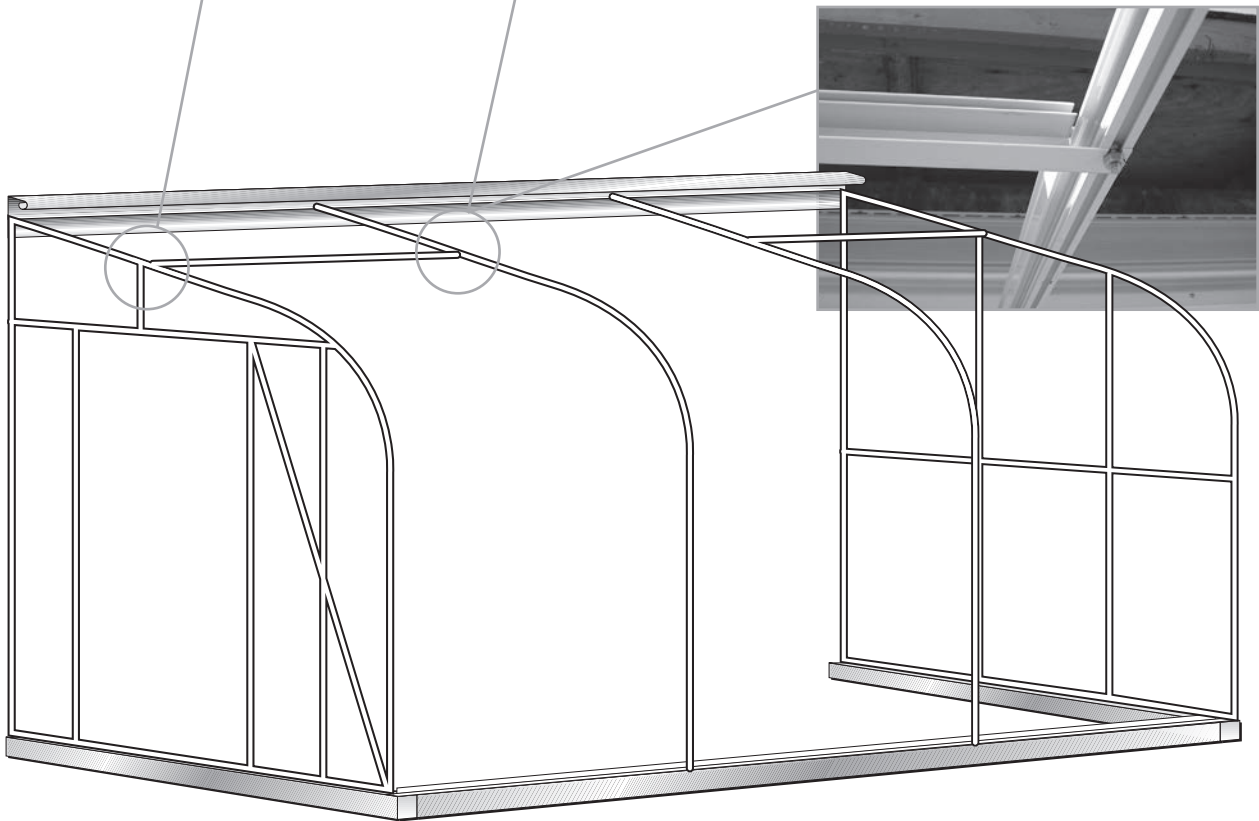
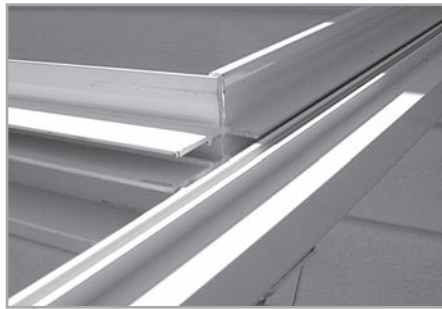
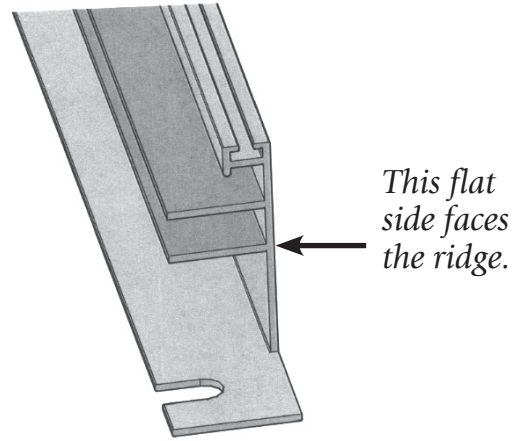

Step 7: Install All Remaining Poly Bars

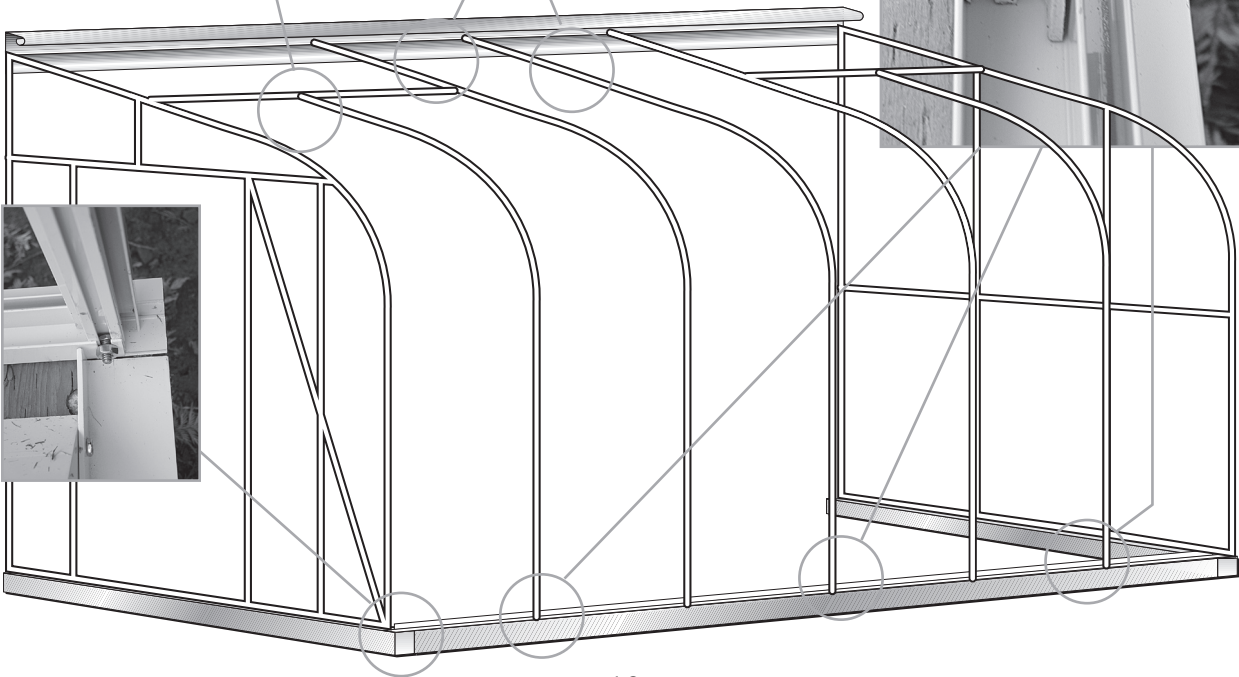
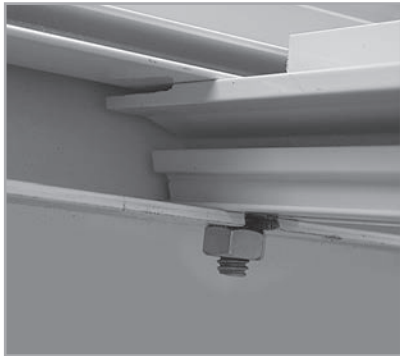

Step 8: Roof Purlin



3" Purlin on larger greenhouses

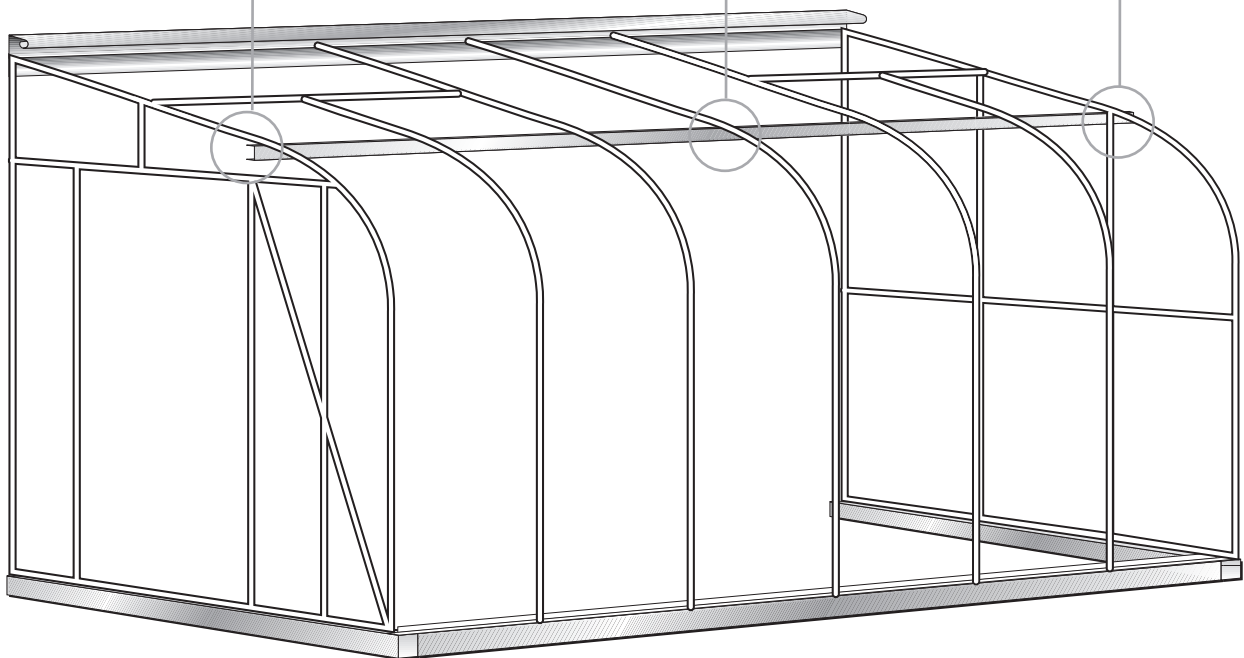

Polycarbonate Panels & Cap Installation

GENERAL INFORMATION ABOUT HANDLING POLYCARBONATE

All polycarbonate sheets are covered with a thin sheet of plastic on both sides to prevent the sheets from becoming dirty and scratching during handling. One side is a clear plastic while the other side is blue or some other colour, depending on the manufacturer. This latter side should be installed so that it faces out. (The sheet is marked to indicate which side should face out.)

Before you begin installing, lay out the sheets lengthwise so that it is easier to take the one you want to install. Do the same with the capping.

Remove all the paper on the foam strip on the greenhouse before you begin installing the panels. If the weather is warm and sunny, the foam strips will be sticky. Take a trigger spray bottle and fill it with soap and water. Just before you install the panels, spray the foam lightly so that the panels can be moved around.

(Do not store polycarbonate bundles outside in the sun. Instead, store them in a cool dark place, such as a garage, until you are ready to use them.)

12. SIDE WALLS

Start with the first long panel and peel off the plastic. Remember to mark in the corner which side is out. Stand the sheet up into the bottom track of the side base/sill. Push the panel against the foam. If the polybars do not line up with the panel, move the greenhouse ridge toward the front or back until the bars line up.

Take the cap, hold it against the panel and position it in the center of the polybar.

Note: Use #8 x 1/2" screws and fasten the cap to the bar (approx 3 to 4 screws to the curve)

Continue to the next panel and follow the same procedure.

When you have completed the side, make sure that the length of the panels are correct. The panels should be approximately 20" shorter at the place where the vents go.

Now go back to the first panel, and at this point you need an assistant. He/she should take a ladder and set it below the vent opening. As you push the sheet down on the polybar, your assistant needs to guide the top end of the sheet into the vent frame slider track. At this point, if the greenhouse is not square, remove the screws in the ridge and move the ridge to the front or back to square it. After the sheet is in place, your assistant should hold it down while you take the cap and bend it over the curved bar.

Fasten the ridge and the upright bars to the wall.

Note: When bending the cap around the curved part of the polybar, do it slowly and put in the screws as you go along. If you push too fast, the cap may buckle. Keep it in the center put in the screws as far as you can reach. Then your assistant can take over. Do this with all the sheets. *(If it is windy while installing the panels, you may need to finish off each panel as you move along.) (See page 23.) (See page 21 for pictures.)*

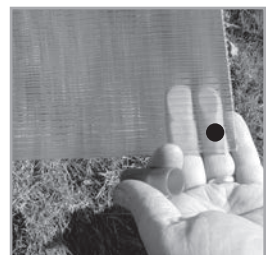

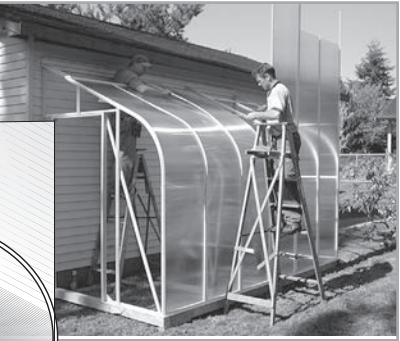
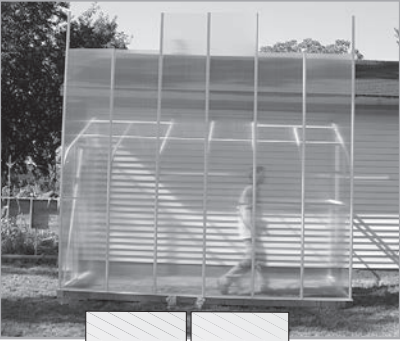
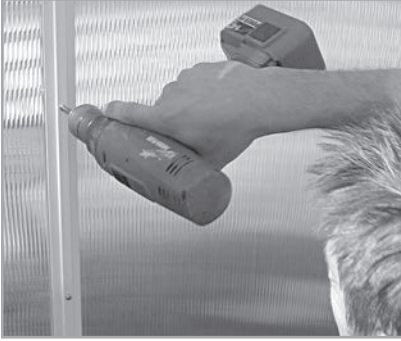

13. BACK/FRONT GABLE-ENDS

Start with the round panels and peel off the plastic. Remember which side is the outside of the sheet. Put on the bottom of the panel an aluminum “**U**” (page 22, picture **1**). Stand up the sheet and push it sideways into the end poly bar track (page 22, picture **3**). Start with the bottom and move upward. You will have to twist the panel to get it in. Another way to accomplish this is to remove the poly bar beside the sheet, push the panel into the end track and then rebolt the poly bar back into place.

For the next panel, put an aluminum “**H**” on the bottom. Stand it up in place, bend the centre of the panel toward you and pop the top of the panel into the track. (You can also slide the panel in the top track first and then push the bottom in place.)

Put the cap on the bar and screw on with #8 x 1/2” screws. Do all other pieces the same way. The panels beside the door are usually narrow pieces and have an aluminum “**H**” on the top and the bottom (The aluminum “**H**” does not slide into the door frame track). Also, make sure that the second track (in the door frame) is used; otherwise, the panel will sit on an angle (page 22, picture **2**). Finish off the door end.

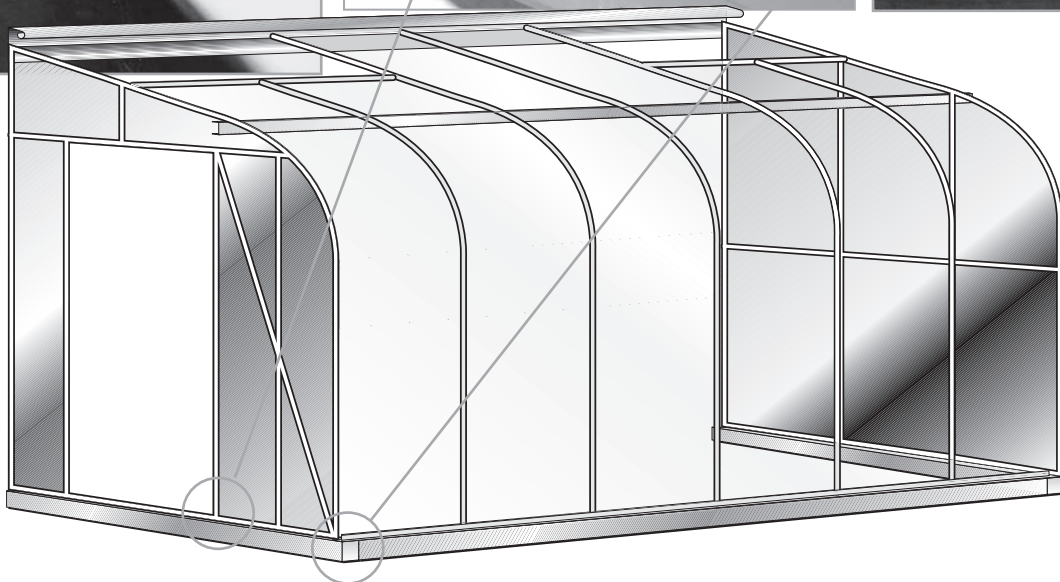
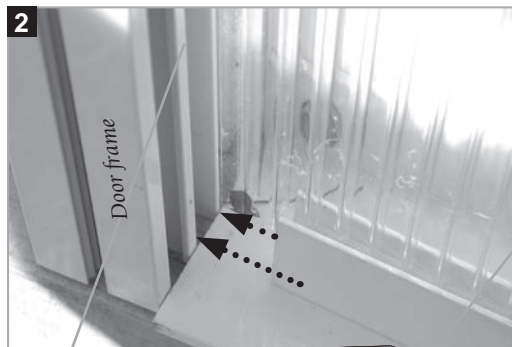

14. SEALING THE GREENHOUSE

When all the polycarbonate sheets are installed, take a tube of clear silicone sealant and seal all the panels that fit into the aluminum tracks on the top, the bottom, the inside and the outside. In this way, you can keep out most of the moisture from the end of the panels. If this sealing process is not done, water will sit in the bottom, fill the inside of the panels and grow algae.

1. Unscrew the plastic nozzle on the tube of silicone sealant.
2. Cut the top of the tube.
3. Screw on the plastic nozzle again.
4. Cut approximately 1/8" off the end of the plastic nozzle at a 30-degree angle.
5. Put the tube into the caulking gun. When using the gun, squeeze the handle slowly.
6. Wherever the polycarbonate sheets are sitting in a track or aluminum "H", seal the edge, including the end poly bars. Also seal the inside of the sidewalls because greenhouse humidity runs along the walls and into the bottom track.
7. Seal the vents before you slide them into place. Seal the places where the panels fit into the door frame bar and the "H" under the above door angle.

CAULKING

- Seal the door frame bar where the base/sill meets the door frame.
- Seal the inside of the base/sill along the perimeter of the foundation.

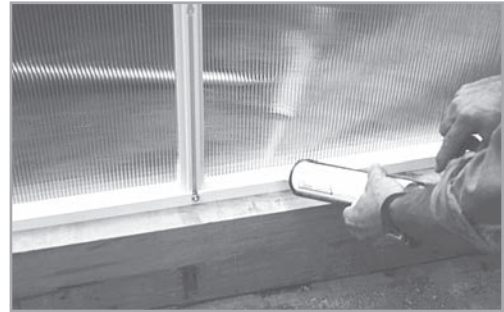

Inside view

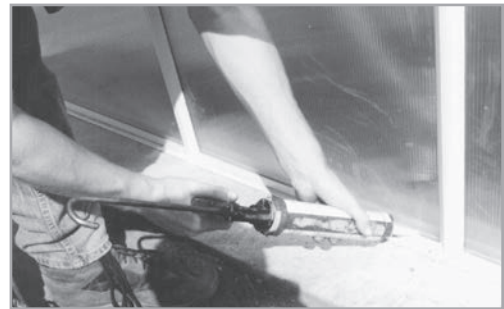

Outside View



Roof

15. DOOR INSTALLATION

(Refer to the drawing.) Take the door and set it inside the door frame. Lift it up as high as possible on the hinge side and put the screws through the existing holes in the door frame. Now the door will hang by itself.

Remove the black clip from the "Z" bar and put one screw into the door frame to hold the "Z" bar. Open the door, take off the clips and put back the screws. Close the door and check that it is square. If the frame and the door are square, then fasten the "Z" bar to the frame. If not, move the "Z" bar up or down to square it. If this is not enough, loosen the bolts in the top plates and move the frame to make it square. When it is in place, tighten all the bolts.

Next install the door handle (see the instructions inside the box). To install the door catch angle, slide in two bolts into the back of the door frame. Bolt on a small angle (provided with the door handle). Face the angle towards the door, line it up with the center of the door handle, and then tighten the two bolts (see picture to the right). Take the door catch out of the door handle box and screw it on. Close the door and adjust the door sweep at the bottom of the door to eliminate potential gaps.

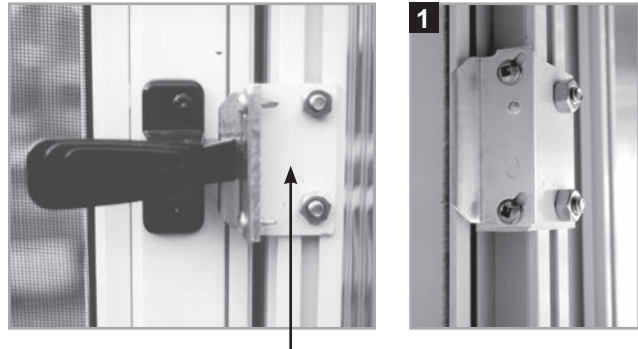

Door Catch Angle

NOTE: There are two types of manufactured doors. The door catch angle on the white door may have to be turned the opposite way as shown on picture 1.

Run a bead of silicone under the angle above the door and against the door frame. Also silicone the "H" on the polycarbonate beside the door to ensure an airtight seal.

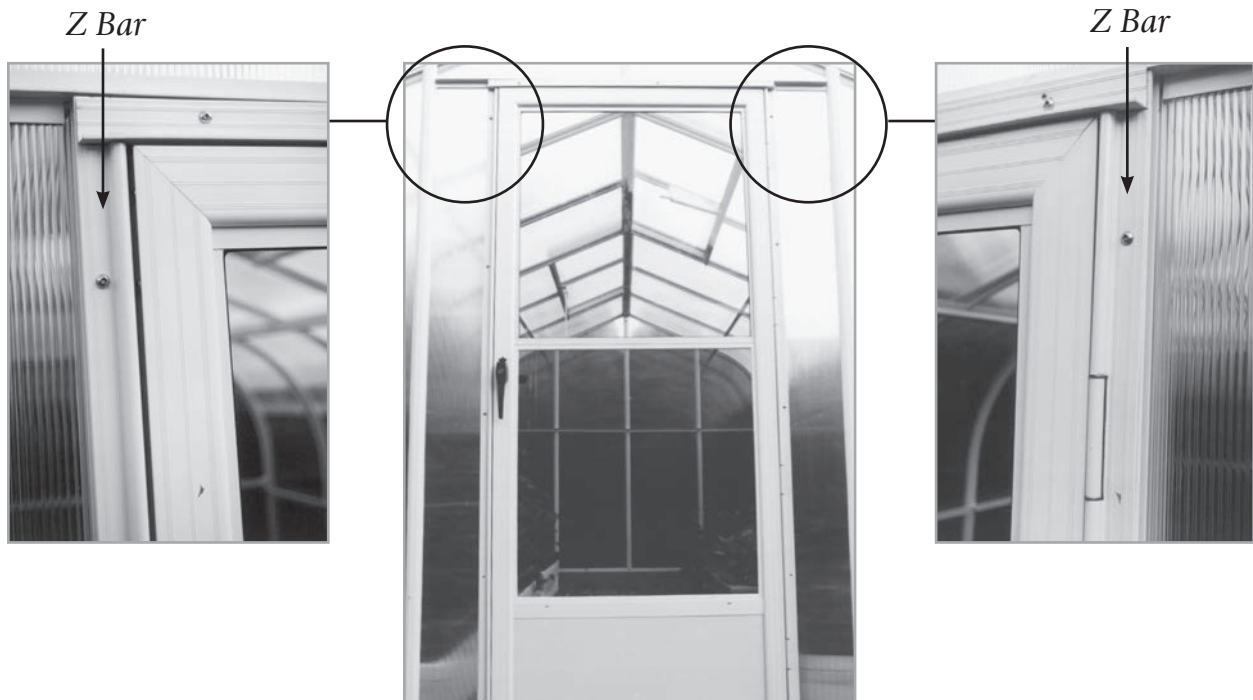

Door Installation

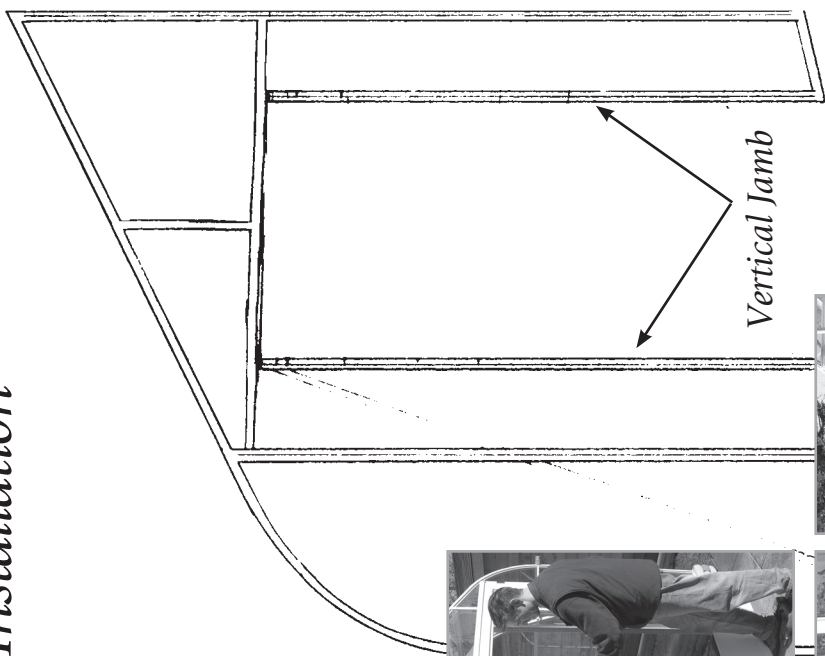
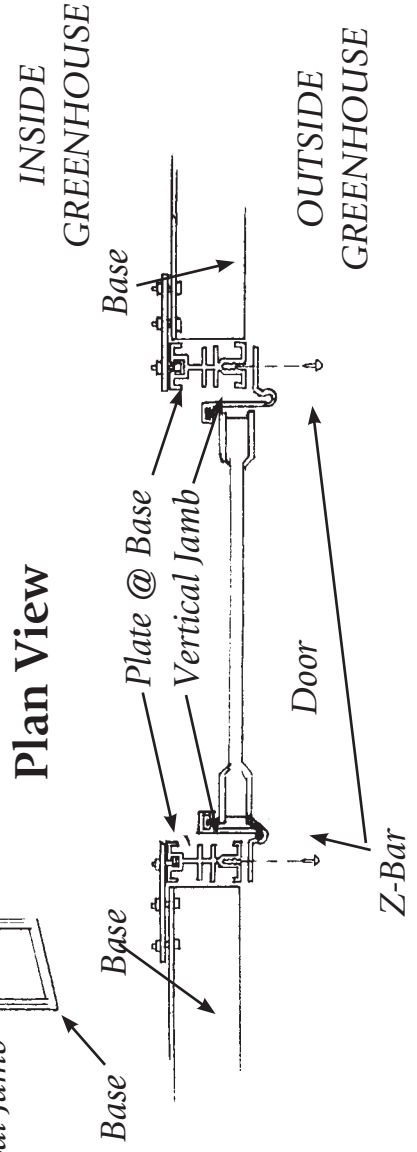
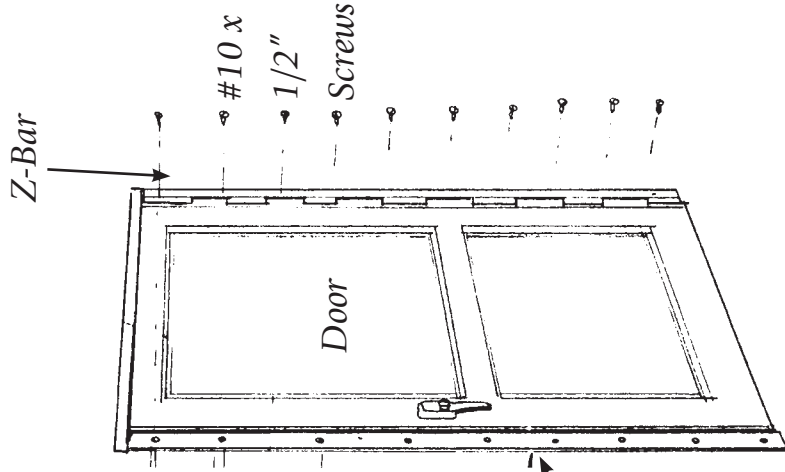

16. VENT ASSEMBLY (SEE DRAWING & PICTURES PAGES 27 – 30)

1. Lay down the gutter with the punches facing up towards you.
2. Poly bars with sliders on are for the end. Lay them down with the bolt slot facing up.
3. Hinge with punches facing up towards you.
4. Slide the bolts into both ends of the end bar. Take the gutter and line up the bolt with the 1st punch, slide the bolt down and tighten it. Do the same with the hinge, other side and center bar. Make sure that the poly bars are tightly fitted to the gutter and hinge after vent assembled.
5. Turn it over and square it up.
6. Put 1/8" foam on the poly bars.
7. Take polycarbonate panel, remove the film (*clear inside*) and slide it into the hinge track. Before you do this; remove the paper and lightly spray the foam so that it doesn't stick. Lay it on the foam and slide it into the hinge (top) section and then down into the gutter track. Do the same with the next piece.
8. Take the caps and lay them on the bars, center them, fasten with 1/2" screws.
9. Take the silicone gun and seal where the sheets slide into the track. *Inside and out.*

17. VENT INSTALLATION

Take the vent and slide it in the end of the ridge. You will have to remove a rectangular screw in the ridge. Then push it into place and put the screw back in. Now attach automatic opener (*next page*).

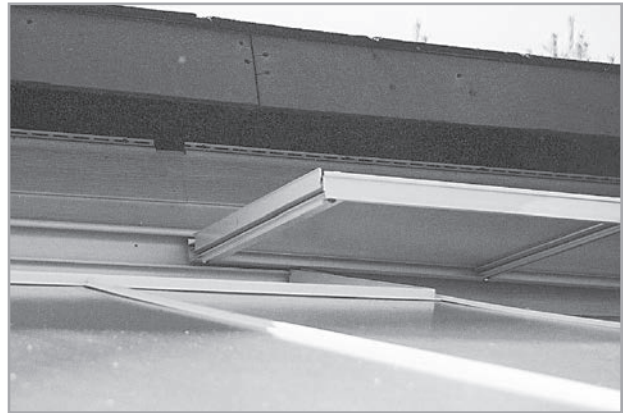

Vent Opener

INSTALLING THE BAYLISS AUTOMATIC VENT OPENERS

Detailed instructions are included in the box with the control (there are a few extra parts). Use #8 stainless steel screws to fasten the Bayliss and vent sill (1) and the vent (2). All holes are already drilled.

After the Bayliss is fastened in place, install the threaded adjuster into the swivel block. This is made easier by lifting the vent with one hand until the piston rod only projects 1/2" through the swivel block.

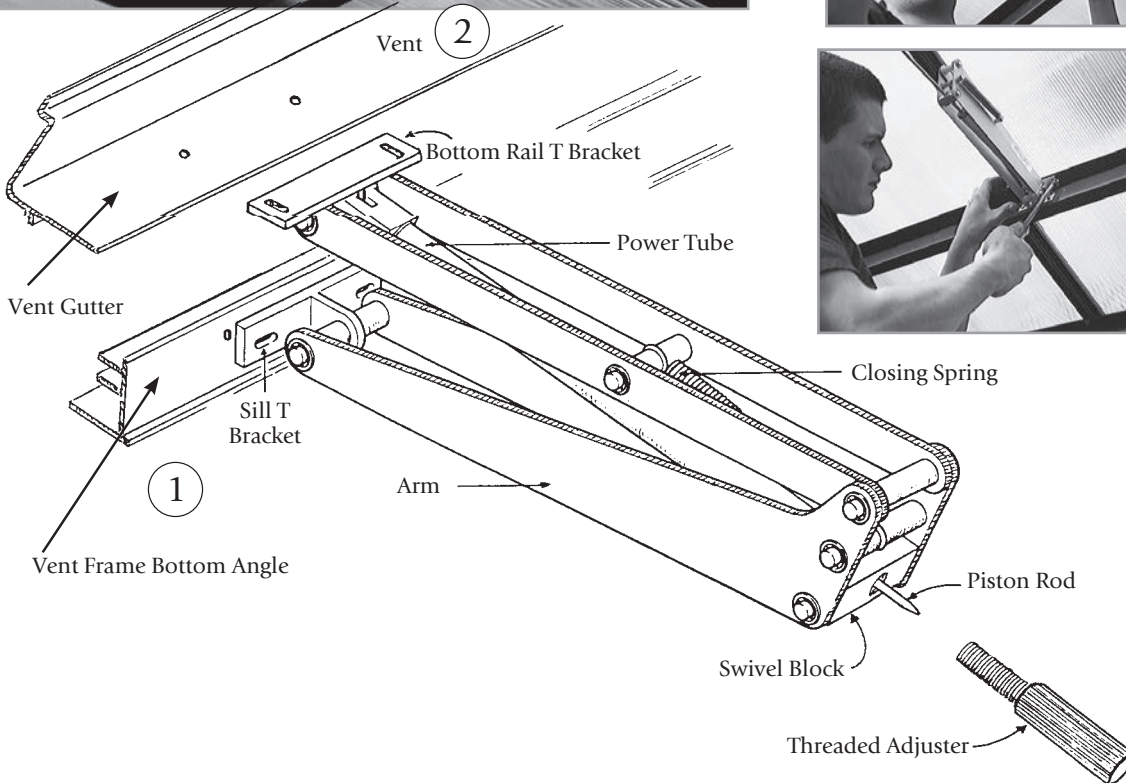

Twin Wall Polycarbonate Roof Vent Assembly - Exploded View

- ALL BOLTS SHOWN ARE 3/8" LONG
- ALL FACE CAP SCREWS ARE 3/8" LONG
- GUTTER END SCREWS ARE 3/4" LONG
- VENT HINGE END SCREWS ARE 1" LONG

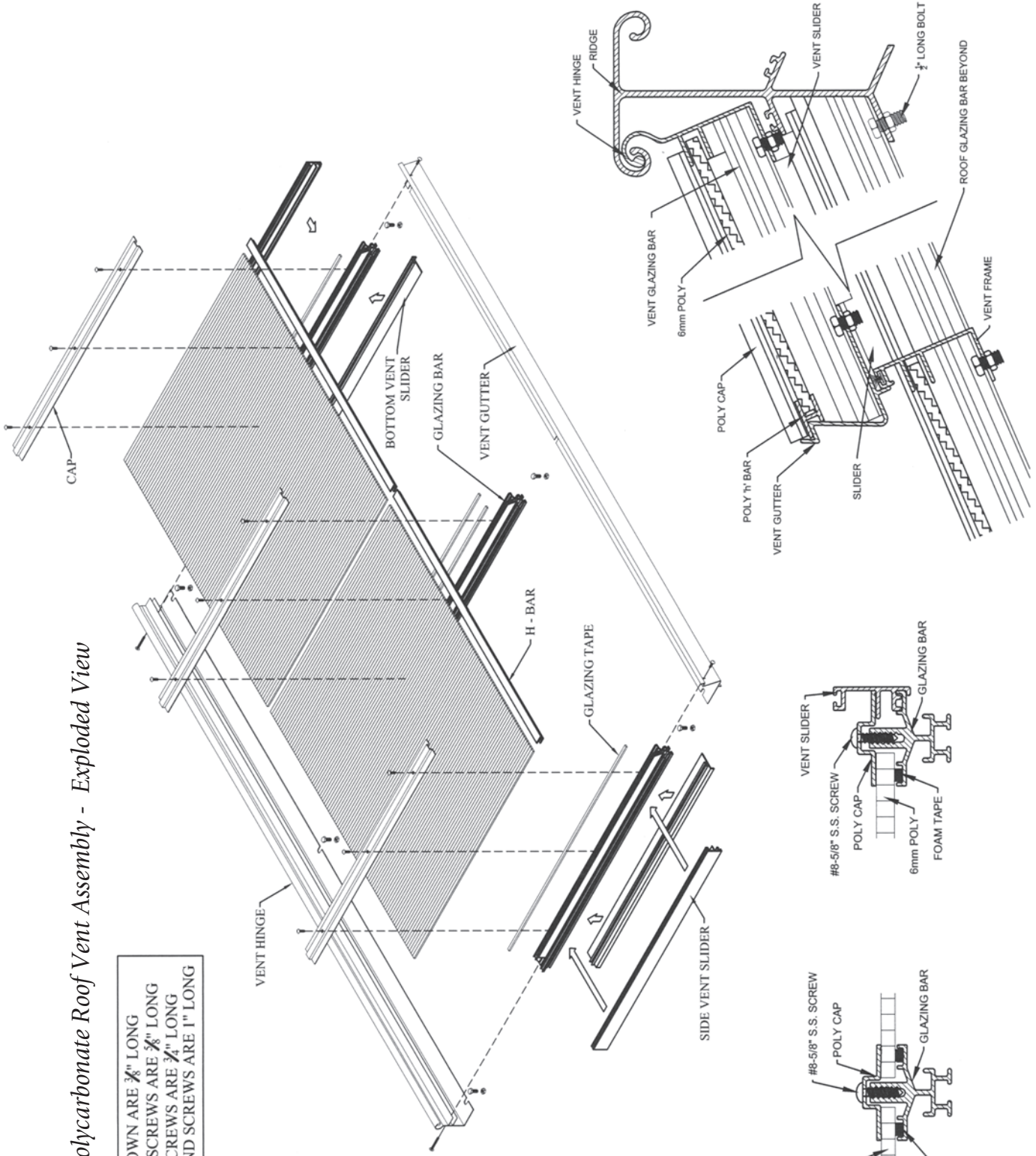

Greenhouse Roof Vent Details

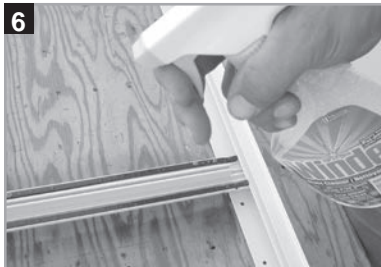
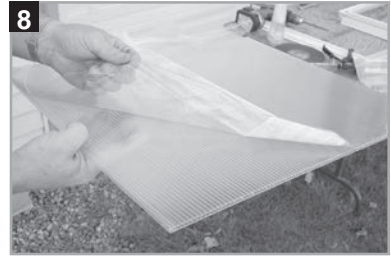
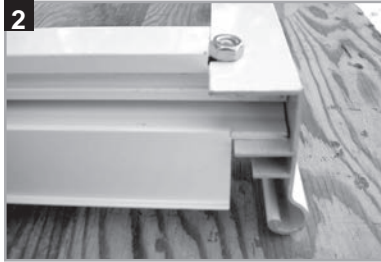

Appendix A

TRUSS SKETCH

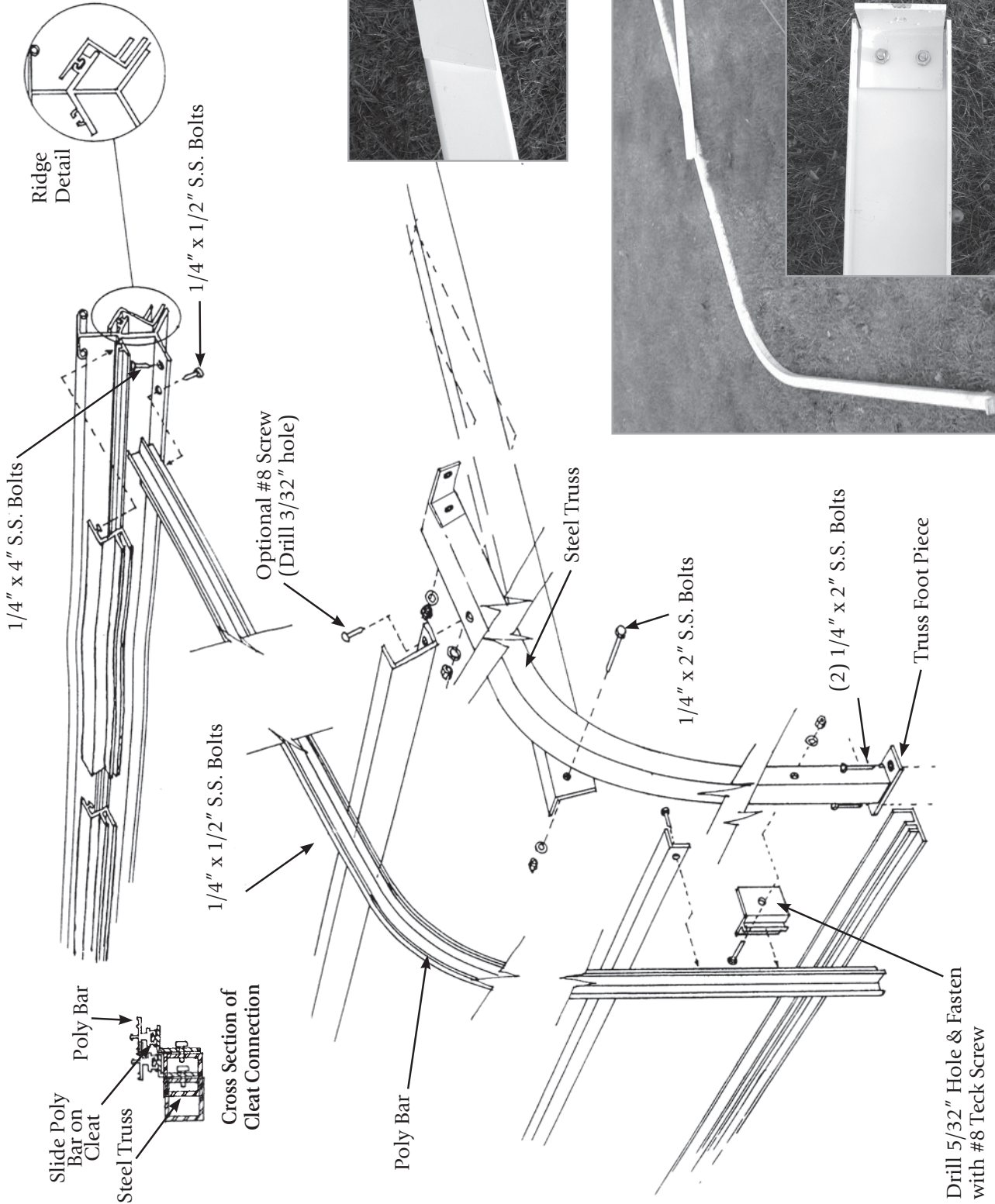

Appendix B – Motorized Intake Shutter

INTAKE SHUTTER ASSEMBLY

Inside View

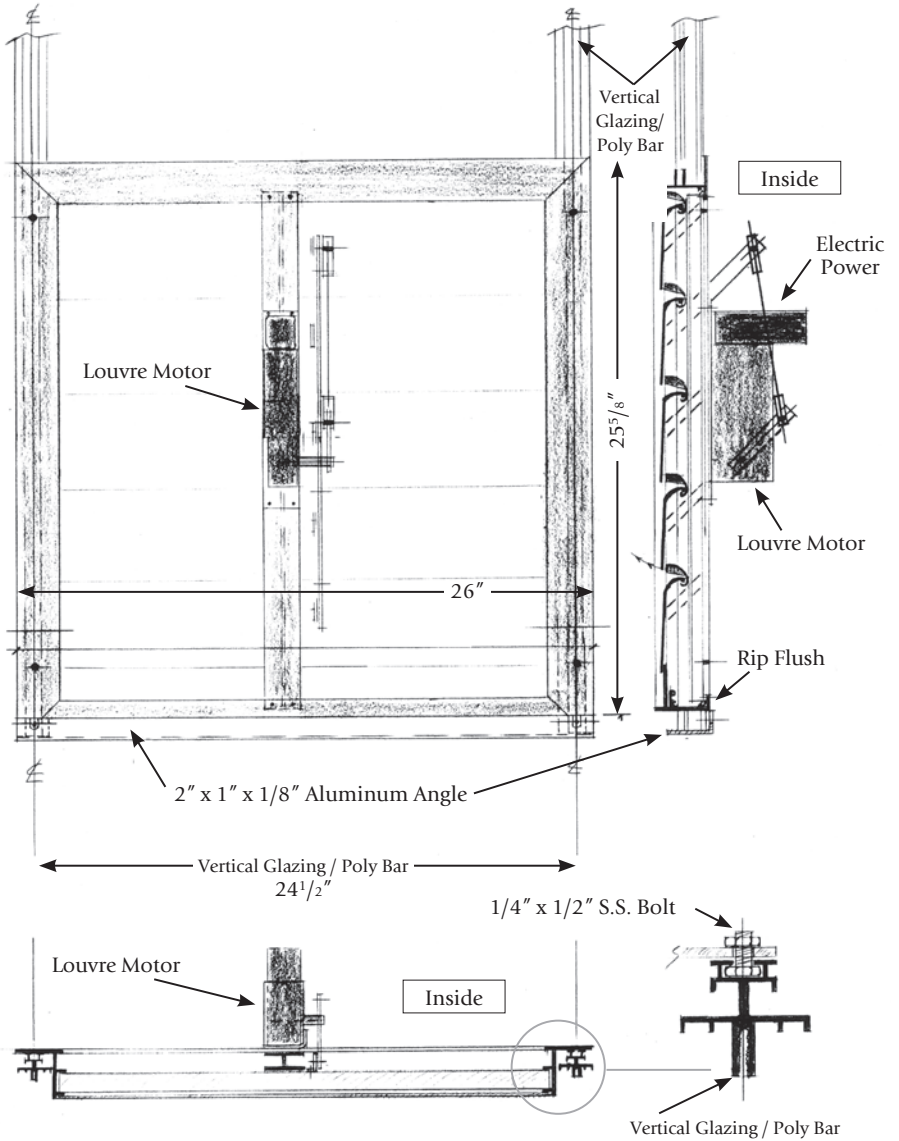

Outside View



Appendix C – Exhaust Fans

INTAKE SHUTTER ASSEMBLY

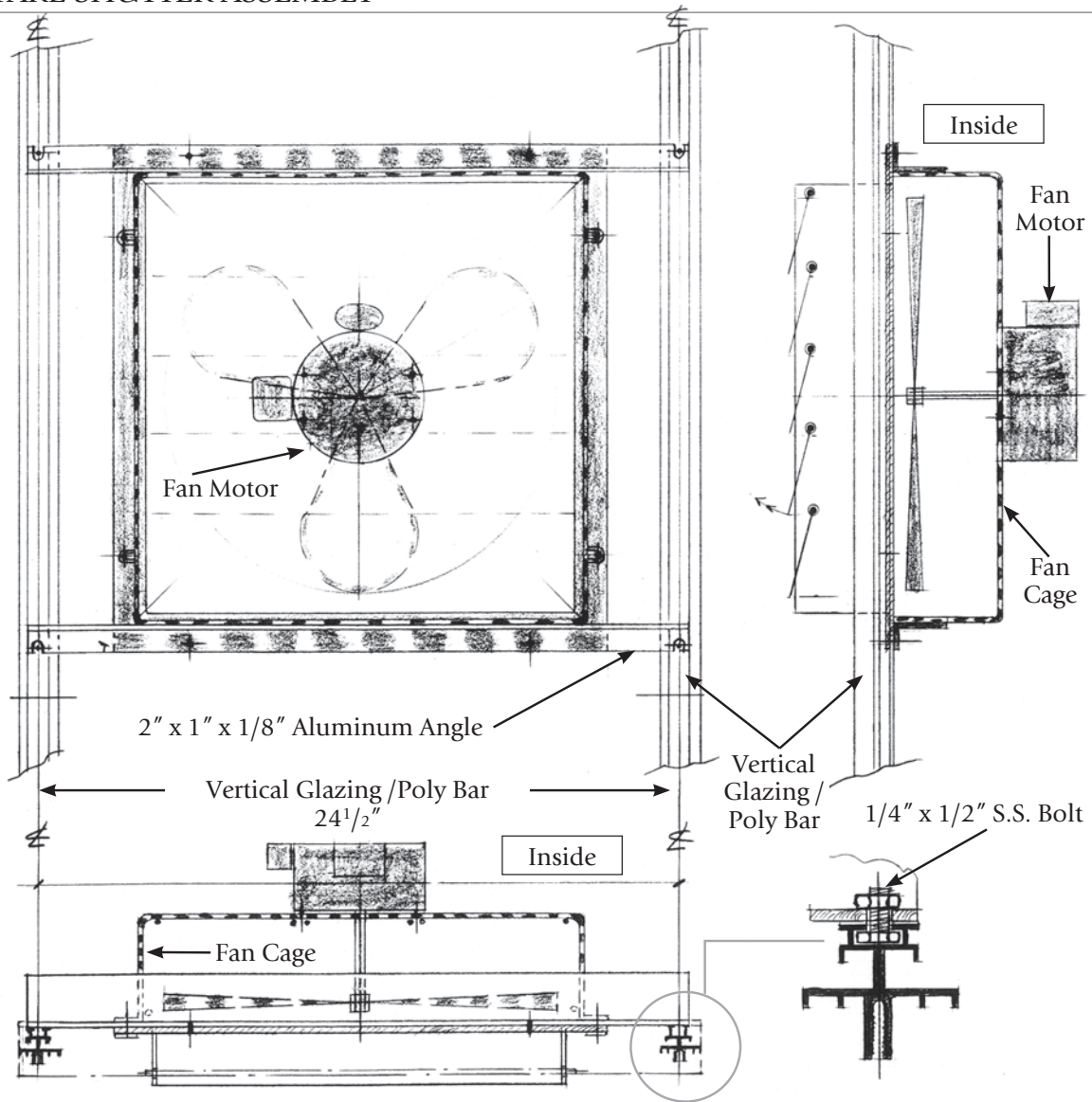

Appendix D – Side Vent

GLASS OR POLYCARBONATE SIDE VENT ASSEMBLY

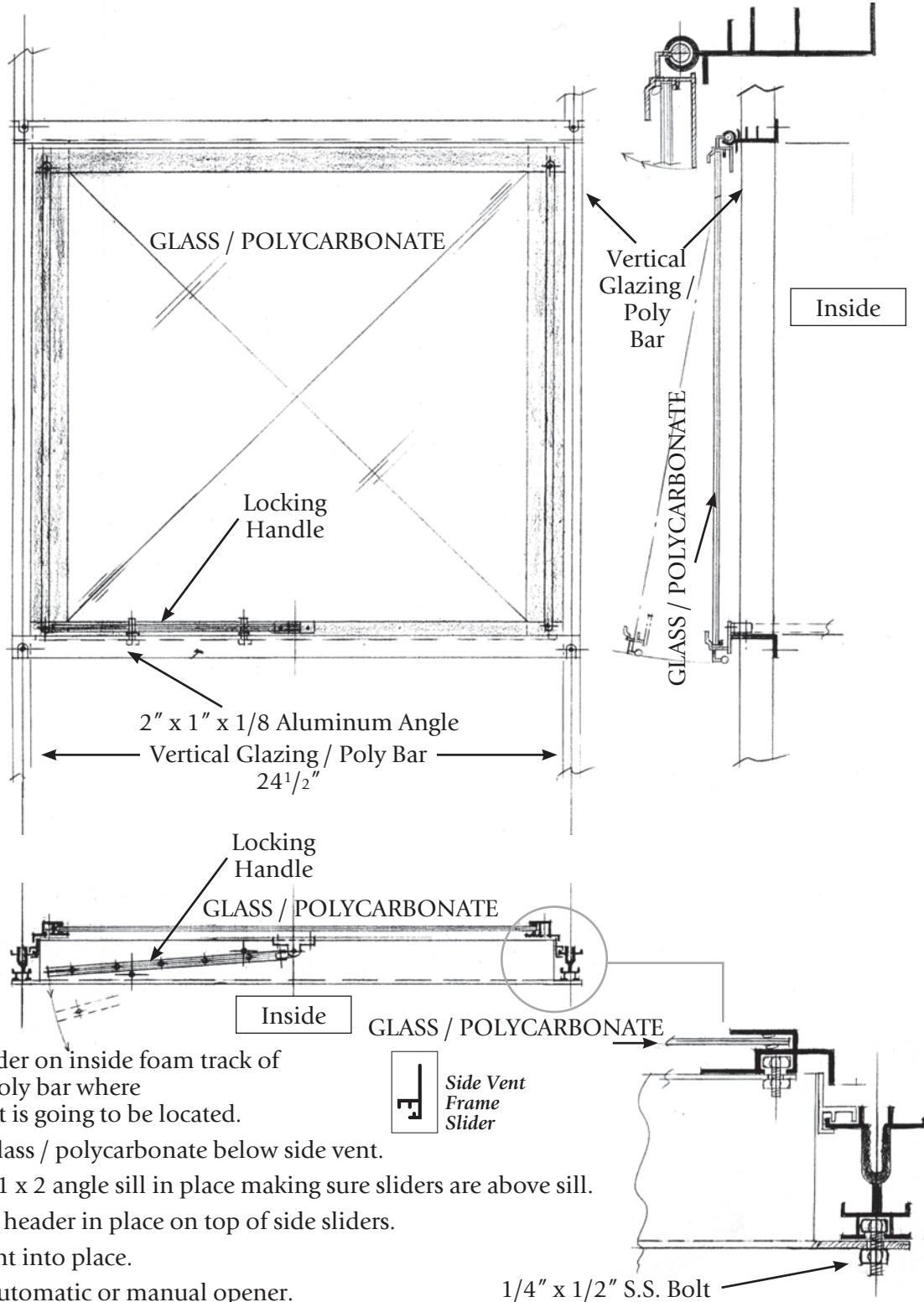

1. Slide slider on inside foam track of glass / poly bar where side vent is going to be located.
2. Install glass / polycarbonate below side vent.
3. Bolt on 1 x 2 angle sill in place making sure sliders are above sill.
4. Bolt top header in place on top of side sliders.
5. Slide vent into place.
6. Install automatic or manual opener.

Appendix D – Side Vent CONTINUED

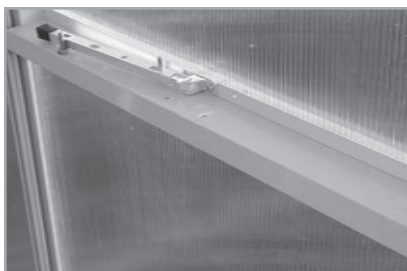
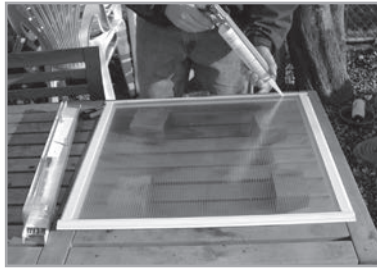
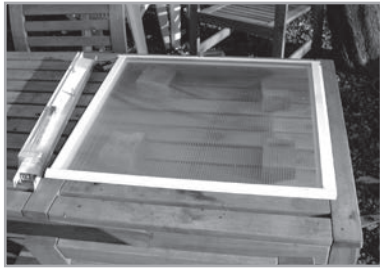

Appendix E – Glass Louvre

GLASS OR POLYCARBONATE GLASS LOUVRE ASSEMBLY



Appendix F – Roof Vent Screen

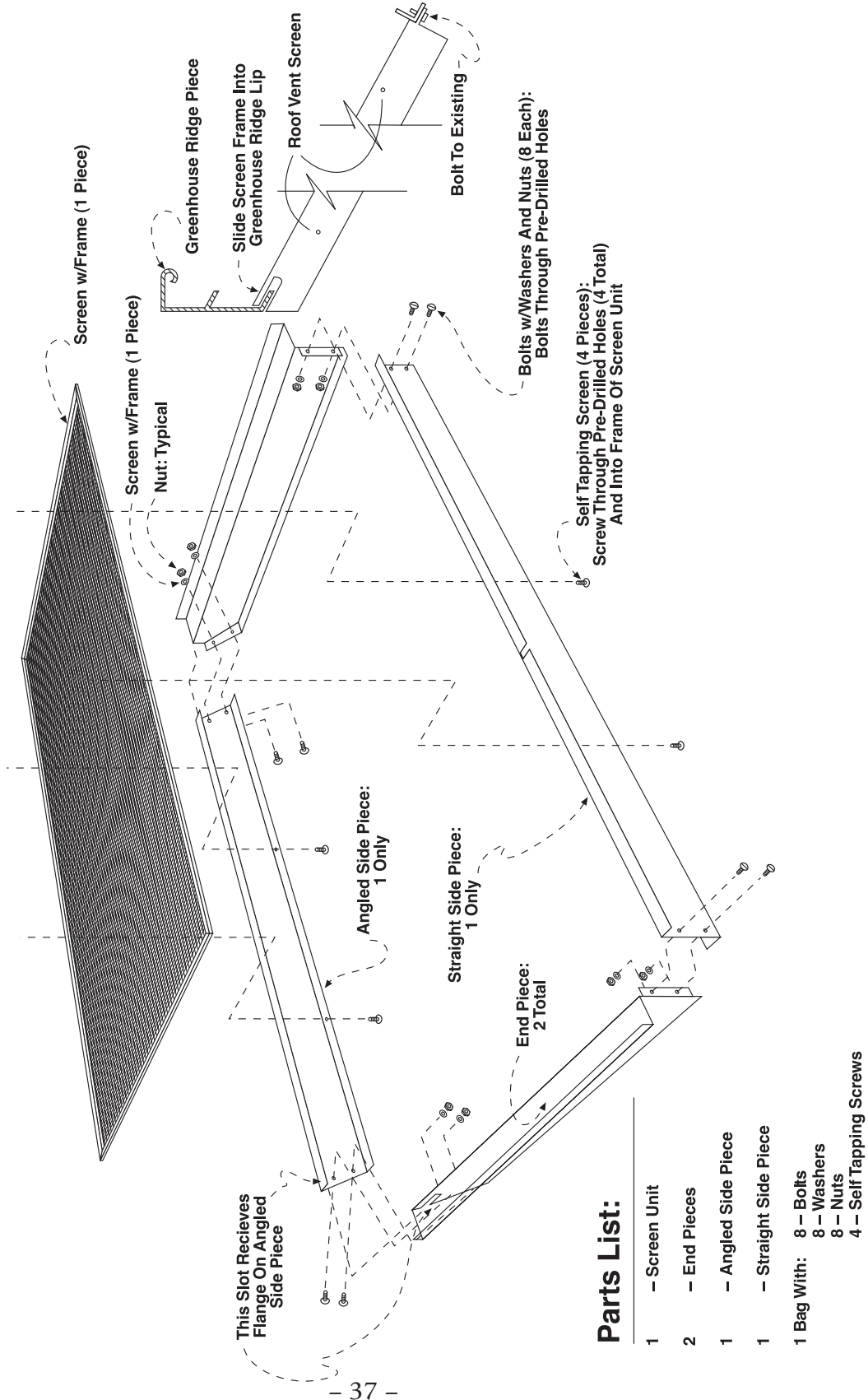

Appendix G – Side Vent Screen

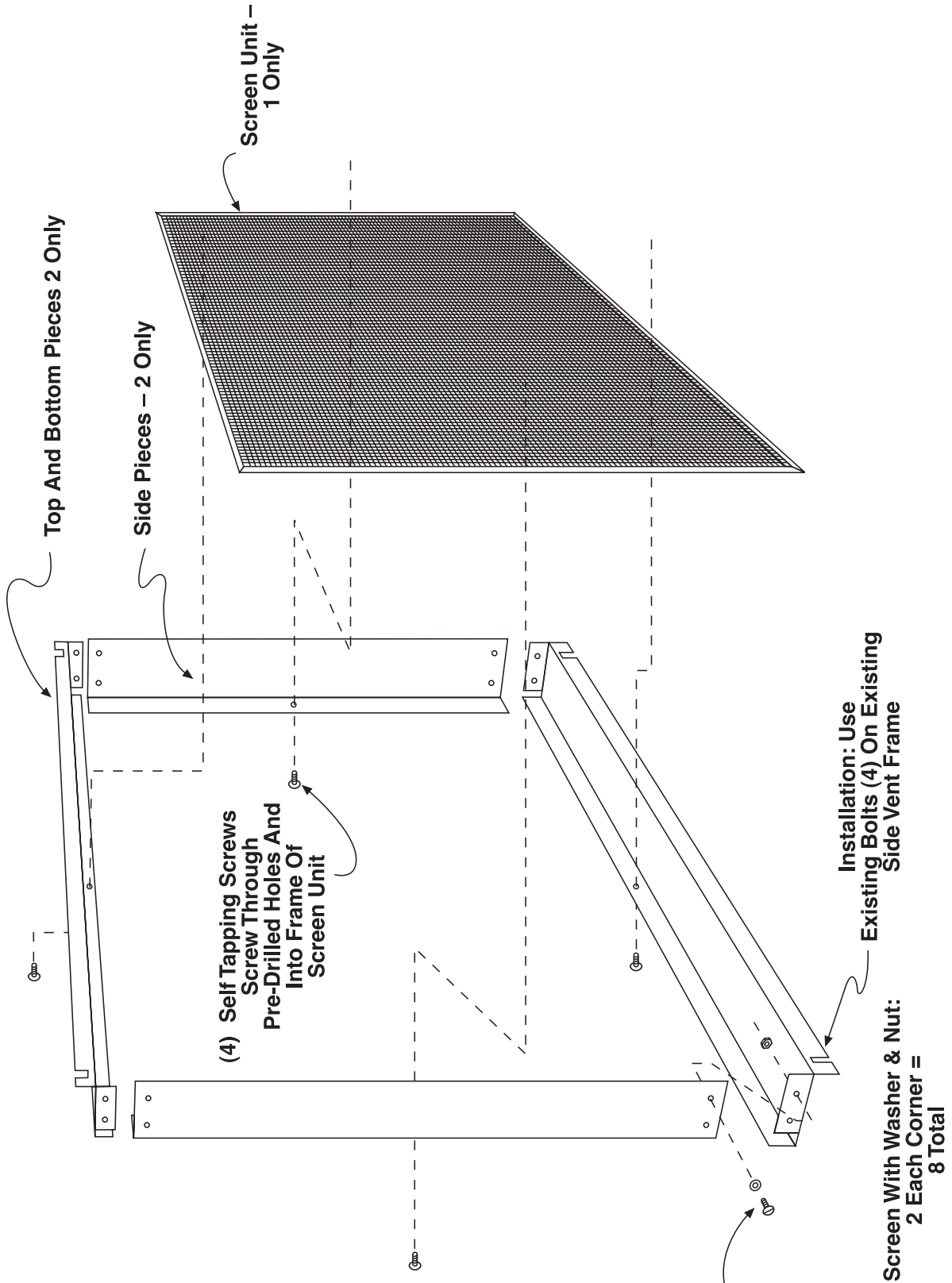

Appendix H – Wire Shelving

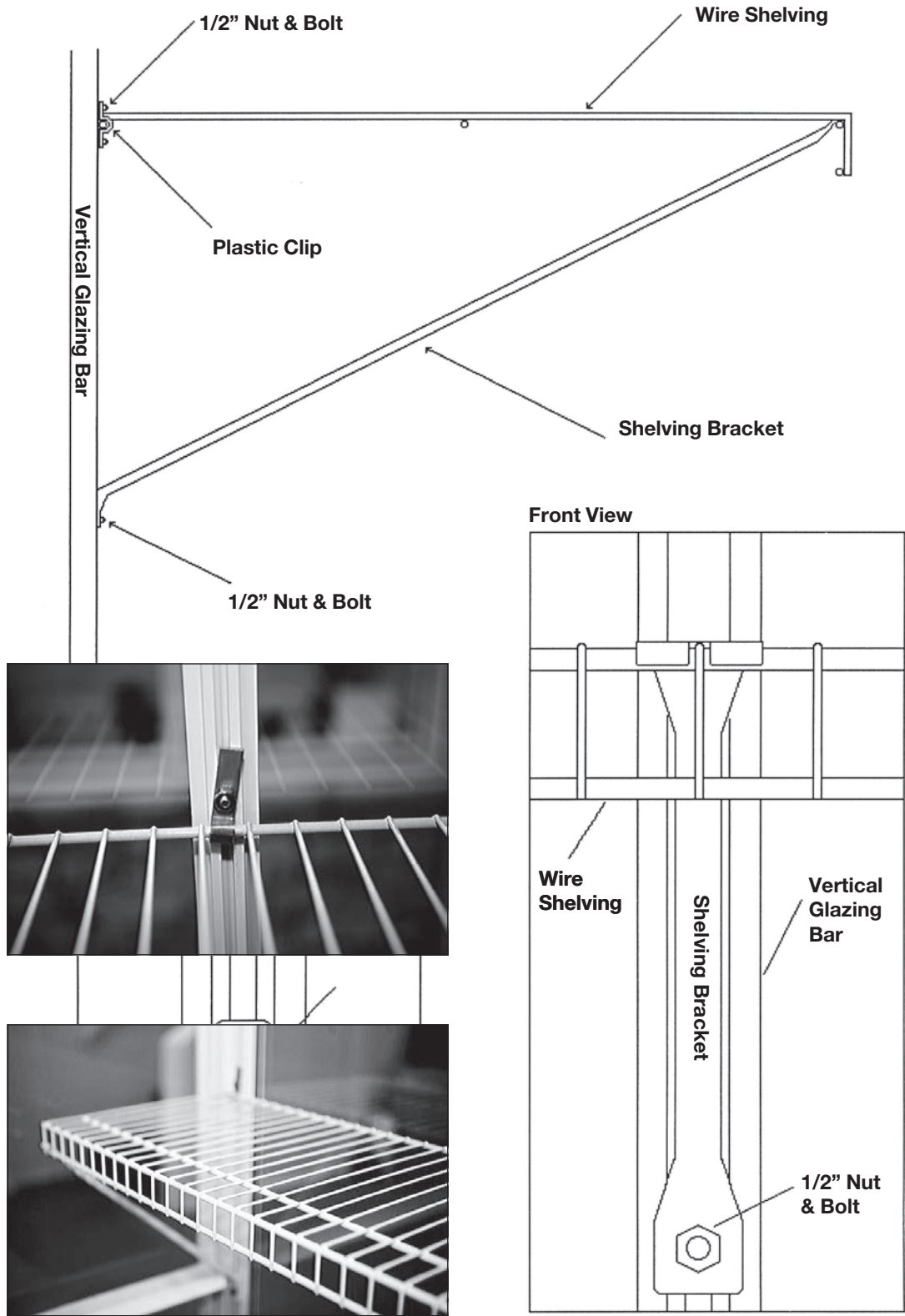



At this point, stand back and enjoy your workmanship.

*Your Cross Country Curved Lean To Greenhouse
should now be closed in and ready for use.*

Congratulations!