

Cross Country **Five-Wall Series** *Lean To Greenhouses*

Model TLT612FW

GREENHOUSE INSTRUCTIONS

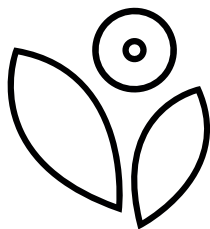

Greenhouse Style
CORPORATION

Telephone: 1-800-665-2124 | Fax: 1-888-273-1251

www.greenhousetyle.com • info@greenhousetyle.com

Contents

Foreword	2
User Notes	2
List of Drawings	3
Traditional Straight Series Component List	4
Foundations	5
Assembly of the Aluminum Frame	
A. Back Gable-End Assembly	9
B. Front Gable-End Assembly With Door	11
C. Sidewall Assembly	15
Aluminum Frame Installation	
1. Side Wall To Back Gable End	16
2. Side Wall To Front Gable End	16
3. Ridge	17
4. Truss Assembly Installation (If Necessary)	See Appendix A
5. Poly Bar With Sliders (#1 or #2)	17
6. Vent Frame Angle	17
7. Poly Bars	25
Taping Poly Bars with Foam	18
8. Fastening The Base/Sill To The Foundation	18
9. Side Vents, Intake Shutter and Exhaust Fan Installation (if necessary)	See Appendices B through E
Poly and Cap Installation	
General Information	26
10. Side / Poly Triple Wall	27
11. Roof / Poly Triple Wall	28
12. End Walls / Poly Triple Wall	29
13. Sealing The Greenhouse	30 & 31
Door And Vent Installation	
14. Door Installation	32
15. Vent Installation	34
16. Vent Assembly	35

Foreword

Your Cross Country greenhouse is designed and constructed to the highest engineering standards and provides structural strength and maintenance-free service for year-round gardening pleasure.

The Cross Country greenhouse must be built upon a firm, level surface. The greenhouse foundation or sill can be made from pre-treated timbers, concrete or bricks. Whatever your choice of material, the base must be square and level.

When selecting a site for your greenhouse, keep in mind that a flat, level site is essential so that the greenhouse can be easily installed and the complete structure is stable and secure. If possible, choose a site with proper water drainage.

Locating the greenhouse in a north-south position is most suitable for raising summer and autumn crops since the sun's rays will be on the greenhouse from daybreak until sunset. An east-west position is ideal for early spring and winter crops since the winter months, with shorter daylight hours, still allow six hours of light exposure to the greenhouse.

Try to locate your greenhouse for easy access, especially to the necessary power and water that is required for greenhouse gardening.

Please watch the enclosed video and follow the steps in this manual for your greenhouse installation. *Remember, if all else fails, read the instructions.*

PLEASE NOTE: *These instructions are generic. Other standard size greenhouses maintain the same details as shown. Amendment instruction sketches may be added to some greenhouses at time of delivery.*

User Notes

The Cross Country greenhouse structure has been designed to withstand extreme weather conditions such as high winds and accumulated snowfall. Hanging baskets and sidewall shelving can also be attached to its sturdy frame. The greenhouse design also makes it possible to add extra sections at a later date.

Sealing the polycarbonate sheets to the aluminum "H" (see sketch) and base is optional, however we highly recommend it.

By eliminating water from entering the inside of the aluminum, will prevent excessive moisture inside the panels.

Once a year the greenhouse needs to be completely washed inside and out. You should do this task when your greenhouse contains the least number of plants, generally just before the garden plants are brought in for wintering over. A recommended cleaning solution is a mixture of soap and water, this will not damage your polycarbonate sheets. Any benches, shelving, plastic trays, pots and baskets should also be cleaned thoroughly. *Prevention is the best known method for controlling pests and diseases in the greenhouse.*

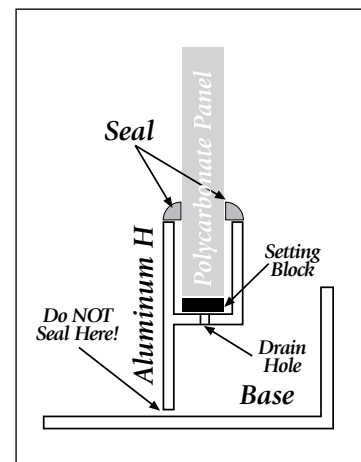

NOTE: Do not store polycarbonate sheets in the sun.

List of Drawings

Foundation Styles	5
Back Gable End Inside View <i>Picture</i>	7
Back Gable End Inside View <i>Detail Line Sketch 1 – 5</i>	8
Front Gable End <i>Detail Line Sketch 1 – 7</i>	10
Front Gable End Inside View <i>Picture</i>	11
Sidewall Inside View	15
Assembly Outline <i>Steps 1 – 3</i>	19
<i>Steps 4</i>	20
<i>Steps 5</i>	21
<i>Steps 6</i>	22
<i>Steps 7</i>	23
<i>Steps 8</i>	24
<i>Door Installation</i>	32
Vent Assembly - <i>Exploded View</i>	33
Vent Detail	35
Vent Assembly - Exploded View	36
Motorized Intake Shutter	Appendix A
Exhaust Fan	Appendix B
Side Vent	Appendix C
Glass Louvre	Appendix D
Perlin Installation	Appendix E
Greenhouse Bench	Appendix F
Roof Vent Screen	Appendix G
Side Vent Screen	Appendix H
Wire Shelving	Appendix I
Miscellaneous Assembly Details	

Cross Country Five-Wall Component List

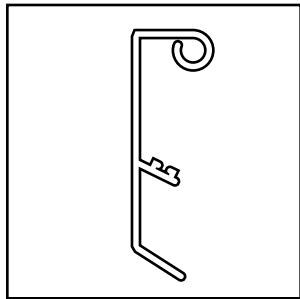

Ridge

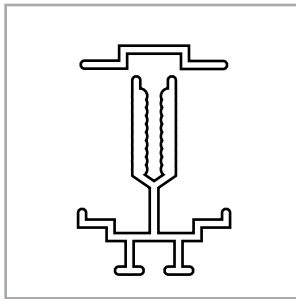

Poly Cap & Poly Bar

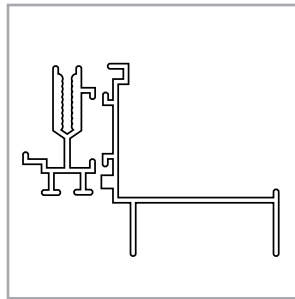

End Rafter

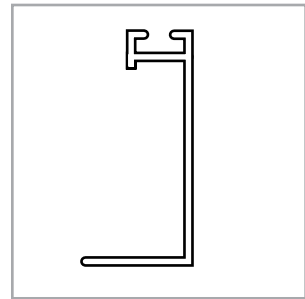

Ventframe Bottom

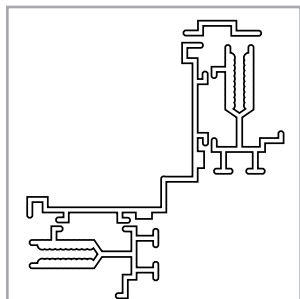

Corner Post

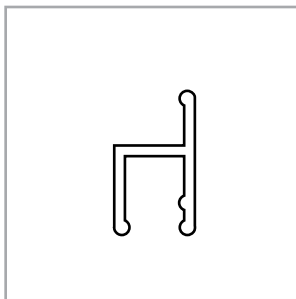

Aluminum "H"

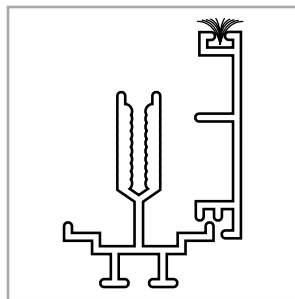

Vent Frame Sides

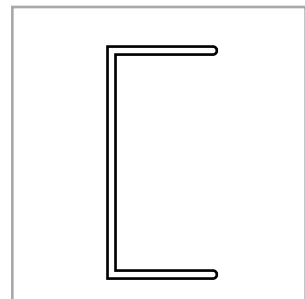

Perlin (if required)



Screws and Bolts

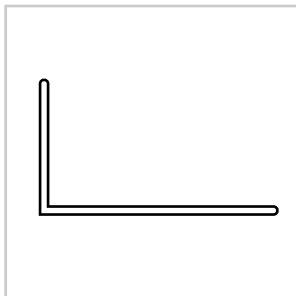

Base / Sill

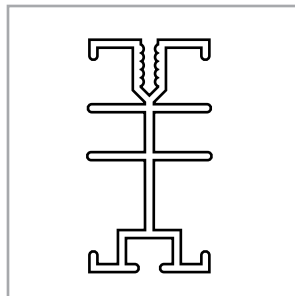

Door Frame

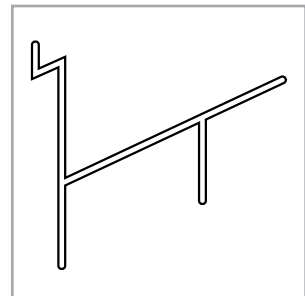

Gutter

Tool

- #2 Square head screw driver
- Measuring tape
- Level to check foundation
- 3/16" concrete bit (concrete foundation)
- 9/64" aluminum bit
- 15/64" aluminum bit fastening perlin to trusses (larger greenhouses)
- 7/16" wrench
- Razor blade cutter
- Caulking gun
- Ladder
- Hammer

Optional

- Automatic Opener
- Circulating Fan
- Max/Min Thermometer
- Benches
- Eyebolts
- Motorized Intake Shutter
- Exhaust Fan
- Thermostat
- Heater

Foundations

Check your local building codes for foundation requirements in your area.

CONCRETE FOUNDATIONS

When you prepare the concrete foundation, the size should be the same as the greenhouse's outside dimensions. One option is to fasten a treated 4" x 4" wooden sill on top of the foundation. *PLEASE NOTE: Especially with concrete, double check all sizes and ensure the forms as square and level prior to pouring.*

PRE-TREATED WOOD FOUNDATIONS

A greenhouse that is 6', 8' & 10' wide can be fastened to a 4" x 4" pre-treated wood timber foundation. For larger greenhouses, a 6" x 6" wood timber foundation is recommended. These timbers are placed on a 4" (10 cm) deep and 8" (20 cm) wide gravel bed. Wood timbers can be stacked to increase the height of the greenhouse. *One advantage of the wood foundation is that it is not classified as a permanent structure. Therefore, if you move, the greenhouse can be dismantled and moved to another location. IMPORTANT: Please see page 6 regarding treated wood information.*

A SQUARE AND LEVEL FOUNDATION

Check the width and length of the foundation's outside dimensions. Then, square the foundation by measuring diagonally from opposite corners in the form of an "X". Next, use a *long* carpenter's level to check and adjust the foundation until it is level. Finally, measure where the door will be placed (in most cases it is 34 1/2" wide). Mark these measurements on your foundation.

IMPORTANT NOTE: If pressure treated timbers are used, a 10mm polyethylene barrier must be used between the wood and the aluminum (see page 6)

Foundation Styles

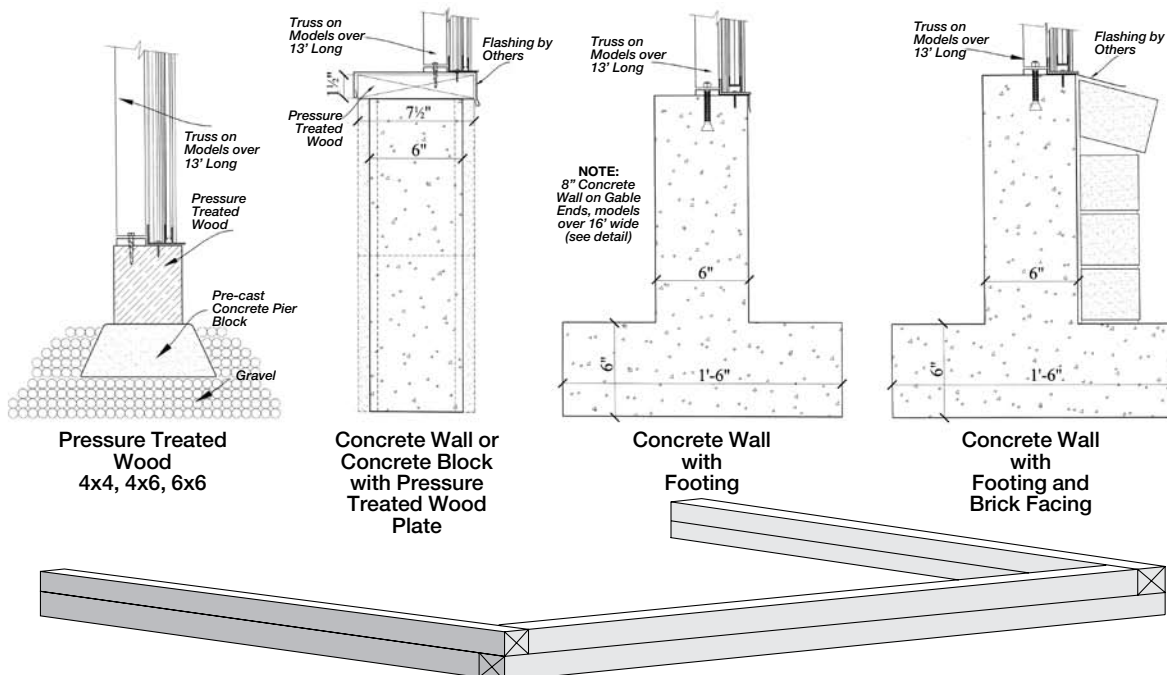

PRE-TREATED WOOD FOUNDATION

Pressure Treated Wood

WHAT IS NEW ABOUT PRESSURE TREATED WOOD?

As of January 2005, the chemicals used in pressure treated wood have been changed. Previous wood was treated with arsenic. However due to the potential long term health hazards this has been discontinued. New pressure treated wood is treated with copper.

The copper in the 'new' wood will be CORROSIVE TO ALUMINUM as well as other metals.

What are 'Greenhouse Friendly' solutions to the new pressure treated wood?

- 1 If you are using the new pressure treated wood, you must place a barrier between the wood and your aluminum frame. Popular barriers include 10 mil thick plastic sheeting, steel weather flashing, a rubber or foam weather membrane, or a row of weather resistant non-treated wood such as cedar or hemlock.
- 2 Other weather resistant non-treated woods are popular alternatives to pressure treated wood. These contain no harmful chemicals and will outlast pressure treated wood. Cedar timbers are a popular choice for greenhouse foundations.
- 3 Concrete foundations have always been suitable foundation alternatives for greenhouses. They can vary from poured concrete slabs, poured concrete perimeter walls to concrete block walls. Although these are usually more costly than wood alternatives, they have the benefit of lasting a lifetime. As they are usually considered a permanent foundation, it is important to check with your building codes to determine what you are able to build.

If you have any questions about using the 'New' pressure treated wood in conjunction with our aluminum greenhouses, please contact our office at 1-888-391-4433.

Back Gable (Inside view)

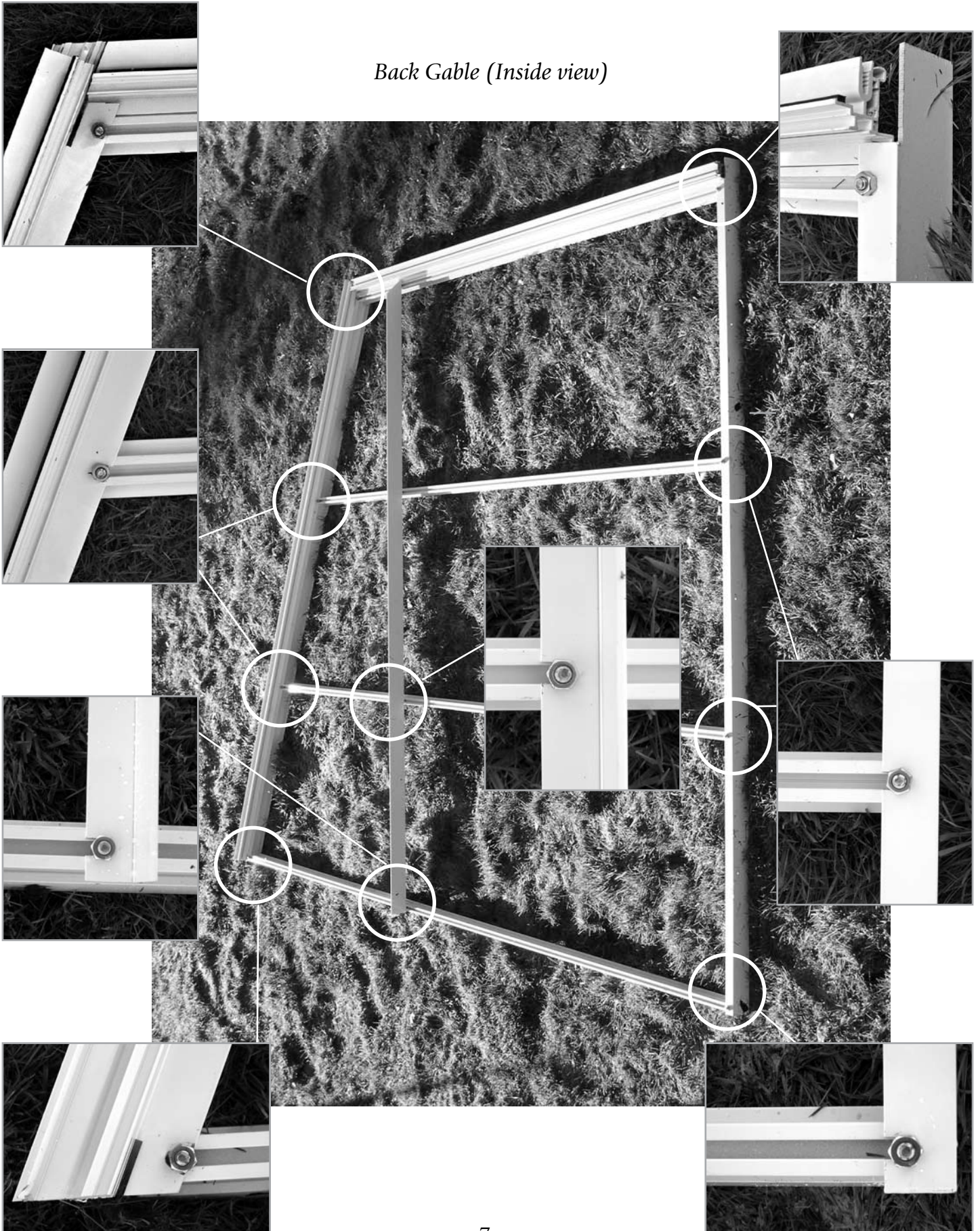

Back Gable End Line Drawing Assembly Procedure

1



Base
(See #9, Page 4)

2

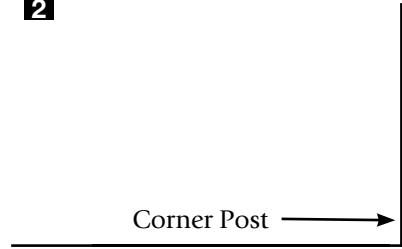

(See #5, Page 4)

3

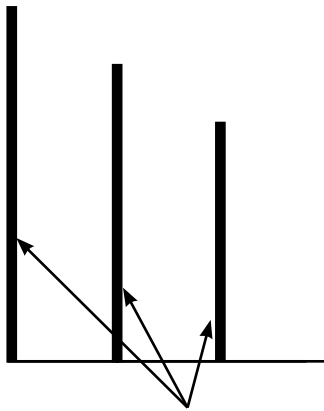

Poly Bars
(See #2, Page 4)

4

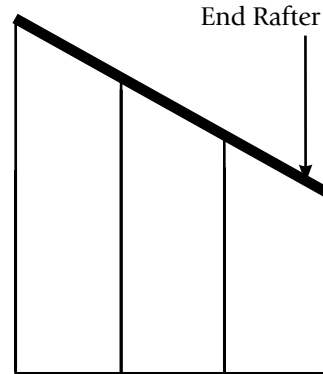

(See #3, Page 4)

5

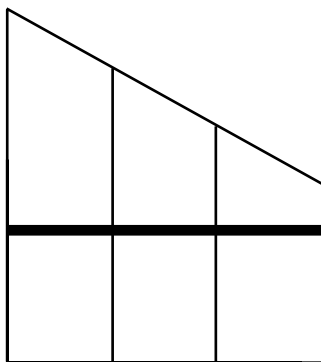

Back Brace
(See #9 or #8 if it is a larger
greenhouse, Page 4)

Back Gable End Assembly

BUILD BOTH FRONT AND BACK GABLE ENDS ON GROUND FIRST

All Poly Bars have a track for the bolts. The track must face up towards you when you assemble the gable ends. Slide the bolts in to the ends or use the notches that are punched out in the Poly Bars.

Lay out the back pieces into the shape of the end wall. See page 6 for details and refer to the line drawing on page 7.

1. The 1" x 2" angle / base laying on the ground should have the 1" side (with the slot punches out) facing up. (See Picture **A** and Sketch 1, page 8)
2. Bolt the corner post onto the base angle. (See Picture **B** and Sketch 2, page 8) (All straight cuts of poly bar and corner post bolt into 1" x 2" angle)
3. Bolt on all the end bars to the base. Make sure that the longest bar is at the end of the back wall, it will have holes in it for fastening to wall (Sketch 3, page 8).
4. End Rafter. When fastening end rafters to the cornerpost (See Picture **C**) and the long end Poly Bar, leave a 1/8" space for gutters and ridge (See Picture **D** and Sketch 4, page 8).
5. The angle horizontal brace is approx. 60" from the base bolted on with 1/4" x 1/2" bolts. (See Picture **E** and Sketch 5, page 8)

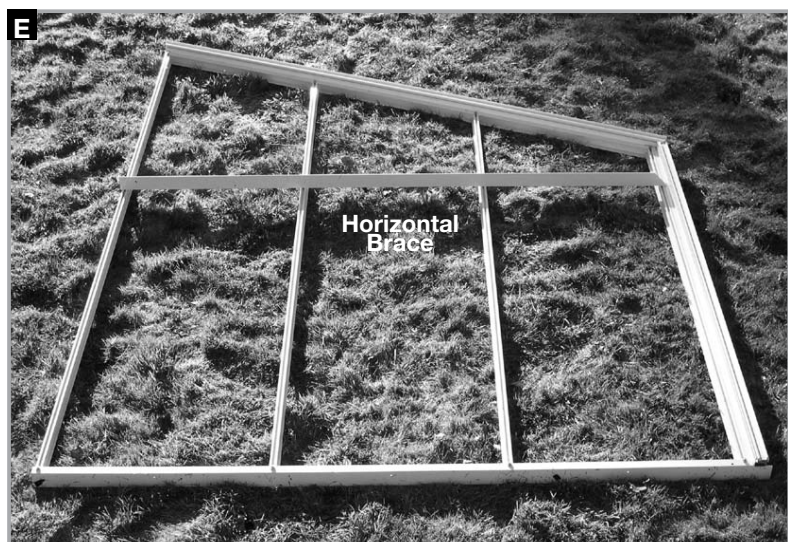
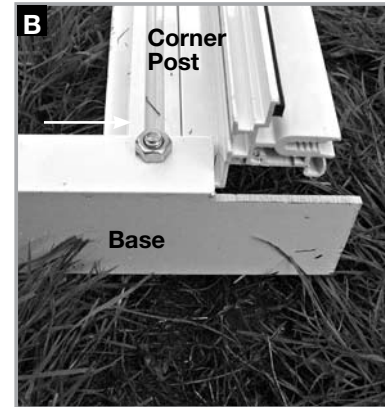
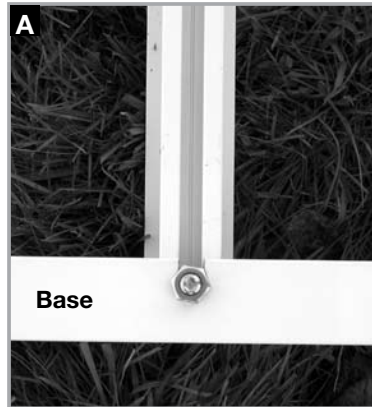

Front Gable End (with door) Line Drawing Assembly Procedure

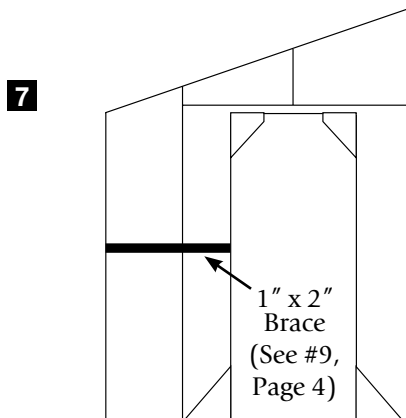
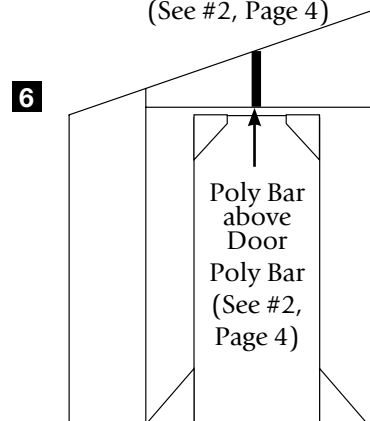
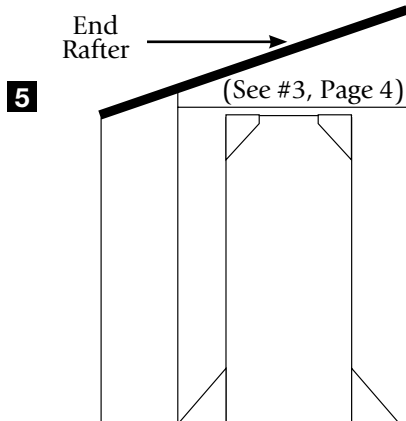
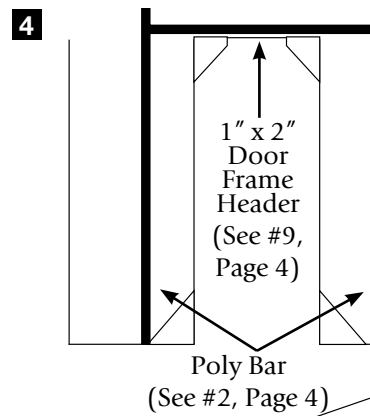
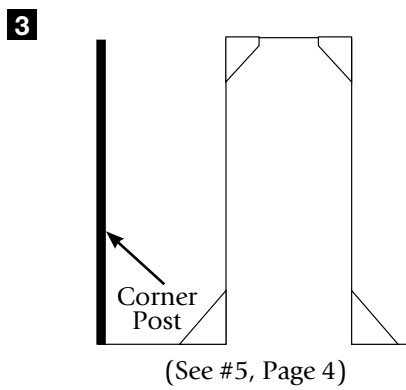
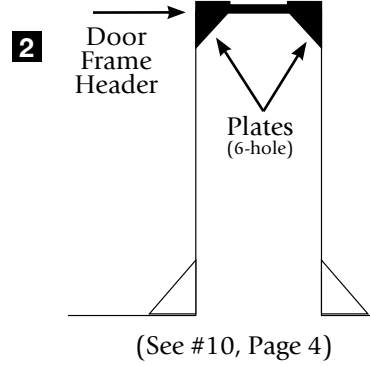
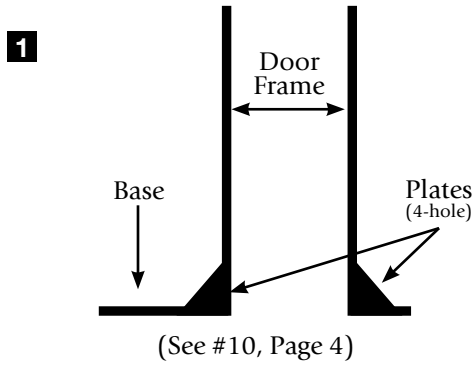

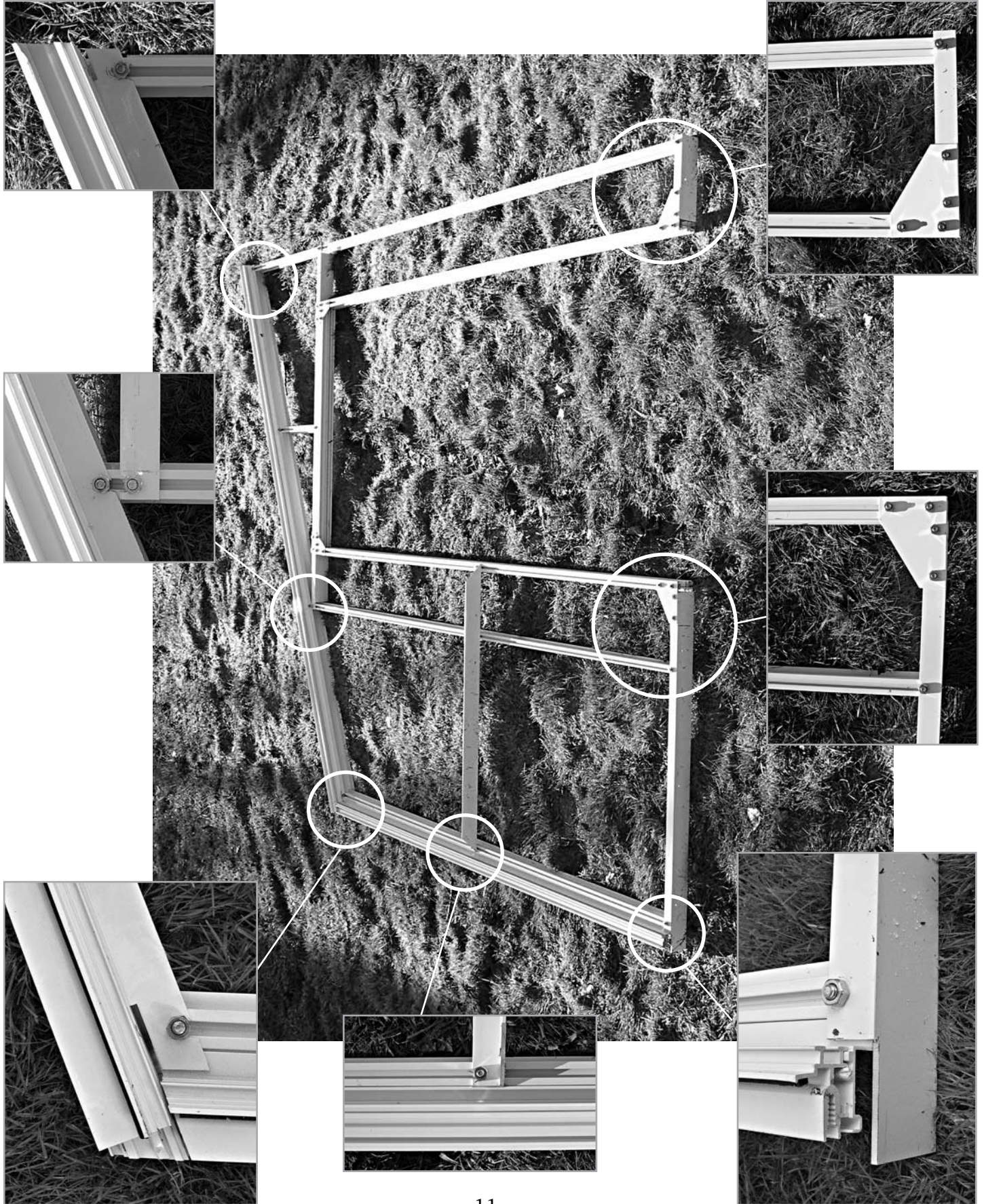

Front Gable End Assembly

Lay out the front pieces into the shape of an end wall. The doorframe and all Poly Bars have a track for the bolts. The track must face up towards you when you assemble the gable ends. Slide the bolts in to the ends or use the notches that are punched out in the Poly Bars. Refer to the line/detail drawings when assembling. *(the sketches/drawings/pictures are viewed from inside the greenhouse).*

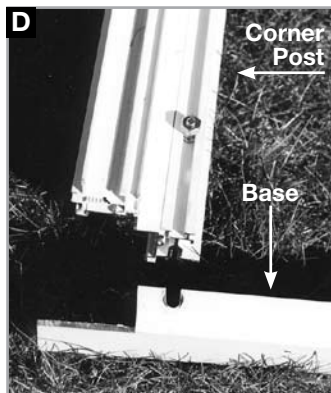
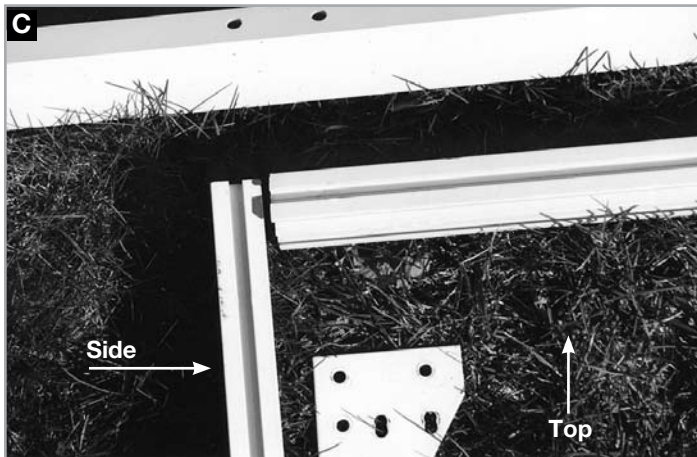

- Bolt the bottom plates (4 holes) to the base/sill and the doorframe sides using 1/4" x 1/2" stainless steel bolts (see Picture **A**, **B** and Sketch 1, page 10). Before tightening the bolts, be sure that it is square. *(If you ordered a greenhouse with a door drop, measure from the bottom of the doorframe to the underside of the base according to the specified distance.)* For door drop See Picture **E** and Picture **F**
- At the top of the doorframe, put on the doorframe header (which looks the same as the side pieces). Put the header *between* the two side pieces and bolt on the plates (6 holes) (See Picture **F** and Sketch 2, page 10). Use the 2 oblong holes to fasten doorframe to header. The plates should stick up 1" above the doorframe. Note how the plates are put on. Before tightening the bolts, be sure to square up the doorframe.
- Take the corner post (angle cut on top) and bolt it to the base (See Picture **D** and Sketch 3, page 10).

Front Gable End Assembly (contd.)

- Take the Poly Bars next to the door frame – (see Sketch 4 on Page 9) and bolt them to the base/sill. The angle cut should match the roofslope (See Picture **E**).

The 1" x 2" angle above the door (49³/₄" long) can now be bolted on. The 1/4" round holes should be lined up with the holes in the plates (See Picture **F**). The 2" side of the angle is facing down. If you put it the other way the centre Poly Bar cannot be bolted on. Each end of the 1" x 2" angle has a slot punched out to accommodate the bolt that is lined up with the Poly Bars 24 1/2" from the center. Slide a bolt in the top of the Poly Bar and fasten the angle to it (See Picture **G**).

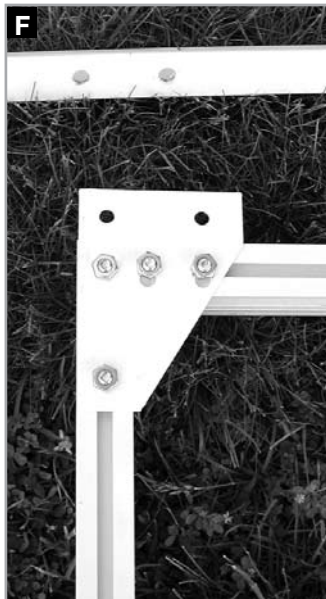

Door Frame Assembly

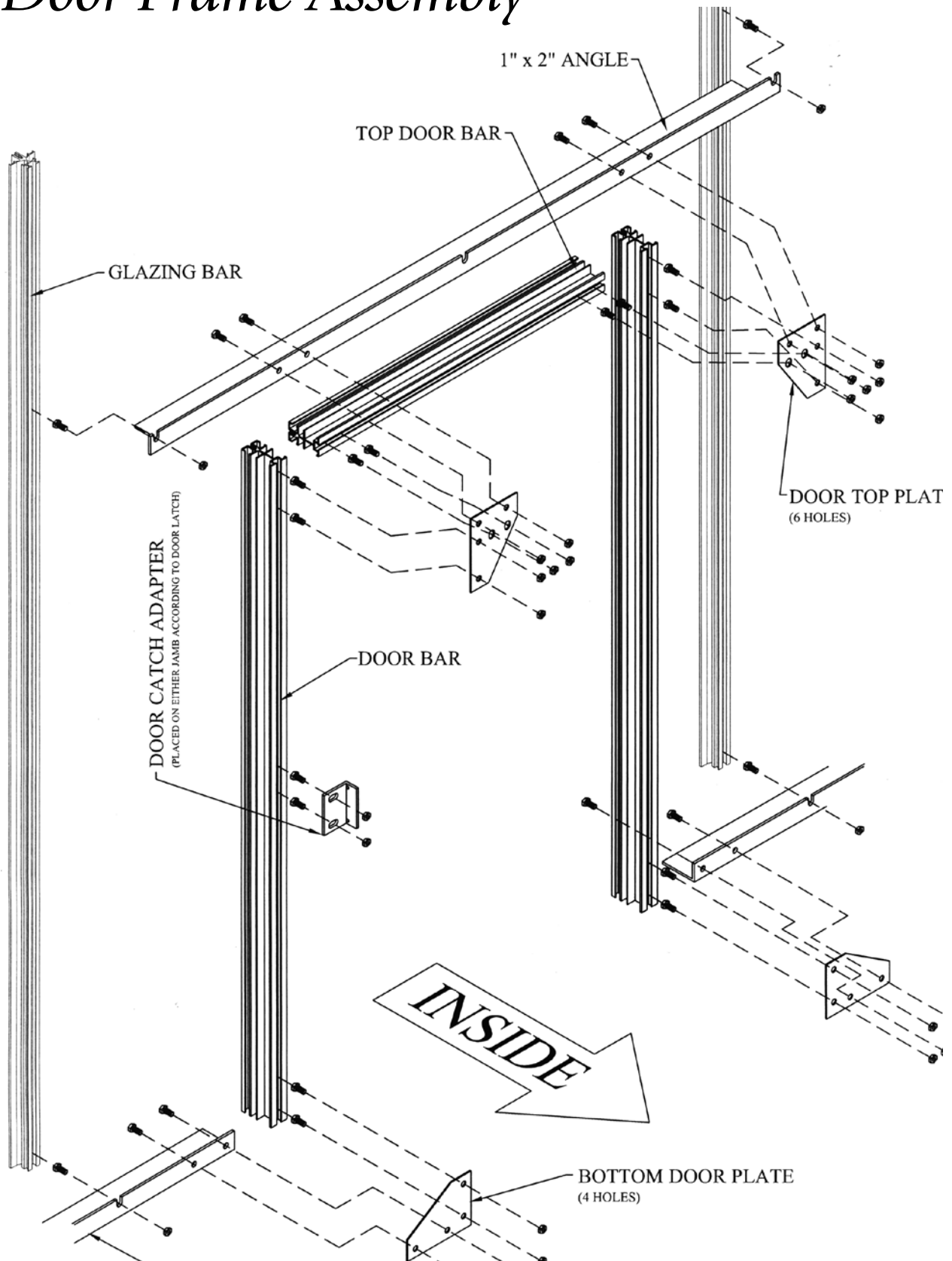

Front Gable End Assembly (contd.)

- End Rafter - when fastening end rafters to the corner post, and long Poly Bar, leave a 1/8" space for the gutter and ridge to slide through (Picture **H** and Sketch 5, page 10). The punch marks in the end rafter will line up with end Poly Bars. Slide the bolts in the top of the Poly Bar before you put on the end rafter.

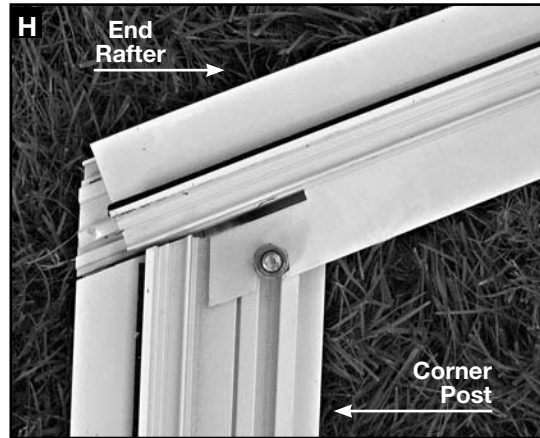

- At this point, you can install all the end Poly Bars. (A smaller greenhouse will only have 1-bar above the door) (See Picture **I** and Sketch 6, page 10).



- Smaller sized greenhouses have a horizontal brace (See Picture **J** and Sketch 7, page 10). Larger sized greenhouses will have a diagonal brace from the top door frame plate to base/sill 2" from the corner post.

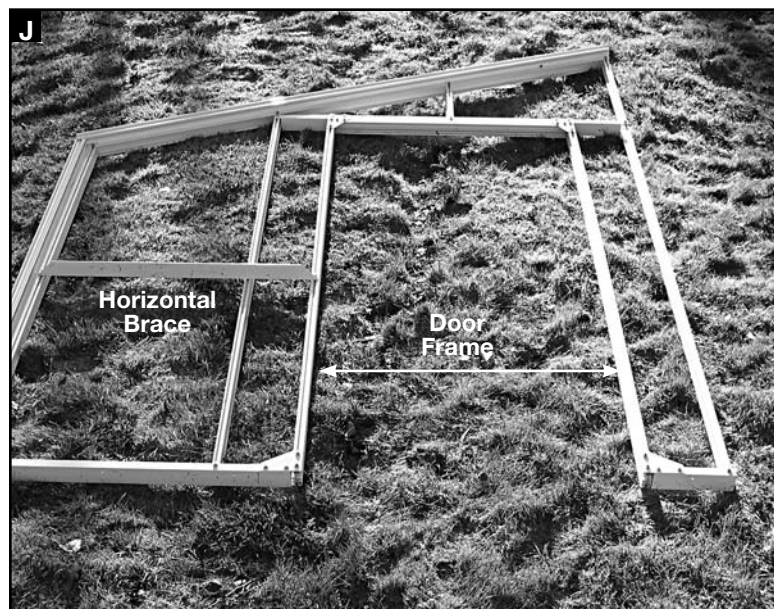

Sidewall Assembly

Lay out the sidewall with the gutter at the top - base at the bottom (See Picture **A**). You will notice that each sidewall Poly Bar has a straight and an angle cut. The straight end fits against the base (See Picture **B**) and the angle goes towards the gutter (See Picture **C**). Always face the bolt slot in the Poly Bar towards you.

1. Take all the Poly Bars and bolt them to the gutter (See Picture **D**). Start your bars approximately 25" in from the end of the gutter and base (See Picture **E**) (Corner post will be fastened to the ends when the greenhouse is assembled).
2. Bolt the Poly Bars to the base. Ensure all Poly Bars fit tight at gutter and base.

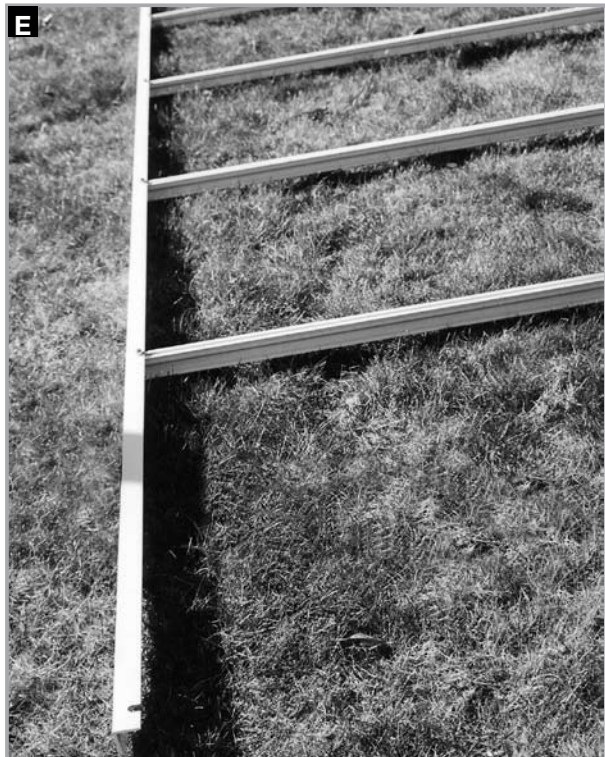
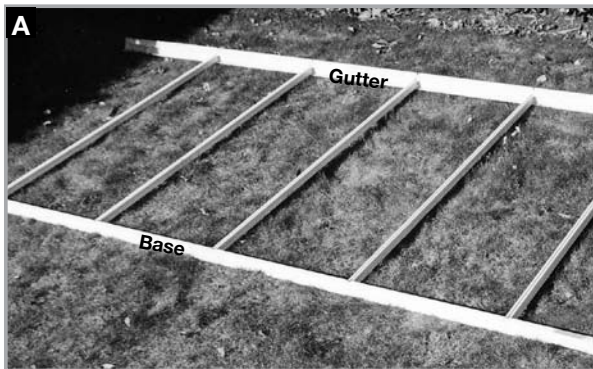

Aluminum Frame Assembly & Installation

1. BACK GABLE END (See Page 19)

Take the assembled back gable end and stand it up on your foundation. (Slide a bolt into the top of the corner post or use the push-out in the back of the Poly Bar, move it down approximately 3" and temporarily tighten the bolt.)



2. SIDE WALL (See Page 19)

Stand up side wall. Slide the gutter (sidewall) in between the end rafter and the corner post. (There should be a 1/8" space - See Picture **A**). By sliding the gutter in as far as it goes, the punched out slots line up with the bolt track in the back of the Poly Bar (See Picture **B**). Undo the bolt in the corner and slide it up into the slot and tighten up. Fasten the bottom base (See Picture **C**). Make sure the side base fits in between the corner and end base.



3. FRONT GABLE END (See Page 19)

Follow the same procedure as the back gable end.



Aluminum Frame Assembly & Installation (contd.)

4. RIDGE (See Page 20)

NOTE: Refer to drawings for ridge height. Before you slide in the ridge, put one bolt in the top of each end rafter bar (*temporarily tighten*). Take the ridge (*one person at each end*) and slide it between the end rafter on the top. You will notice the punched-out slots in the bottom flange of the ridge. The end slot lines up with the bottom side of the end rafter Poly Bar. Now slide in the ridge and loosen the nut, slide the bolt up into the ridge slot. Make sure that the Poly Bar is tight against the ridge – use a 7/16 flat wrench (*at this time you can temporarily fasten the ridge to keep it from moving around*) (See Picture **E**).

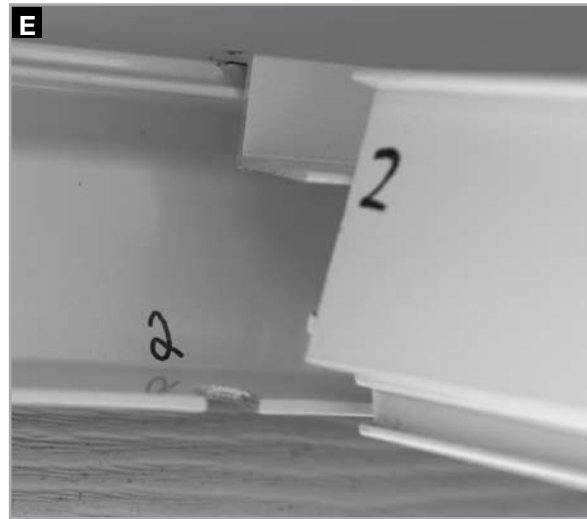

5. POLY BAR WITH VENT SLIDERS (See Page 21)

Each Poly Bar may have a small vent frame slider on it. They are marked 1/2/3/4 etc. On the ridge there will be the same markings. Slide a bolt in the top of the Poly Bar. Put into place with the angle cut on top (*Note that the numbers are the same*). Line it up with the punched out slot in the Ridge. Slide up the bot and fasten it. (See Picture **F**).



6. VENT FRAME BOTTOM SECTION (See Page 22)

The vent frame bottom fits in between the Poly Bars that you have just installed (See Picture **G**). The 2" side of the angle faces towards the Ridge. Move the bolt up the Poly Bar from the bottom and slide it up to fasten it.



7. REMAINING POLY BARS (See Page 23)

All remaining Poly Bars can now be installed. Make sure that the top is against the ridge. Before you tighten the Poly Bar on the gutter, eyeball the gutter to see if it is straight. There is usually about a 1/8" space between the Poly Bar and the gutter.

8. ROOF PURLIN (CHANNEL) *(See Page 24)*

When installing the roof purlin, mark it out by measuring from the ridge. The roof purlin should be located approximately the center between the ridge and the gutter, on models up to 16' wide. Models over 16' have extra purlins. Always face the open end of the purlin up towards the ridge so that it can be used for hanging baskets. Every Poly Bar has notches punched out so that the head of the bolts can be inserted and can slide up or down on the bar *(for larger greenhouses the purlin will be thicker and heavier and you will have to use longer bolts, 1/4" x 3/4", to fasten the Poly Bar to fit)*.

9. TAPE ALL POLY BARS *(See Page 25)*

Complete all taping with the 1/8" foam tape - *install side vent frame sliders before taping the bars (if it was not done before)*.

Don't put foam strips between the poly and the base, and beside the door frame and gutter.

10. FASTENING THE BASE

(See Pages 30 & 31)

Use caulking to seal the base to the foundation as well as against the wall, behind the ridge / upright bars. Before you seal behind the ridge and end Poly Bars, square your greenhouse using the 3/4/5 method

(see sketch). Sometimes the foundation is level but your wall is not plumb. You may have to decide to pull the greenhouse away from the wall or make your foundation off-level.

When your greenhouse is squared up, mark the edge of the ridge on your wall and pull your greenhouse away from the wall and seal behind it. Push the greenhouse back to the wall and fasten it with screws. **NOTE:** *Sealing can also be done after greenhouse is finished and before the vents are installed.*

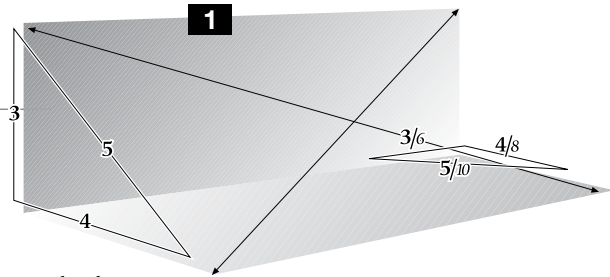

11. SIDE VENTS, INTAKE SHUTTER AND EXHAUST FANS INSTALLATION (IF NECESSARY) SEE APPENDIXES B THRU E. THEN RETURN TO THE NEXT PAGE AND CONTINUE

Note: *Make sure the greenhouse is fastened to the foundation with 1" screws. Square corner-to-corner and ensure base/sill is level.*

IMPORTANT OPTIONALS

SIDE VENTS, INTAKE SHUTTERS AND EXHAUST FAN INSTALLATION: See Appendix B-E *(Pages 39 – 41)*.

TRUSS: If the greenhouse is larger than the instructions show, it will require a truss. Insert a truss after the Ridge *(See #4 Page 17)*. Follow up with installation of the Perlin *(See #8, this page)*. Truss assembly sketch is on Page 36.

Assembly Outline

Step 1:
Back Gable End

Step 2: Side Wall

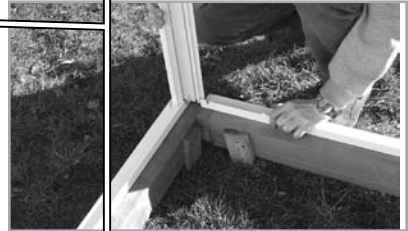
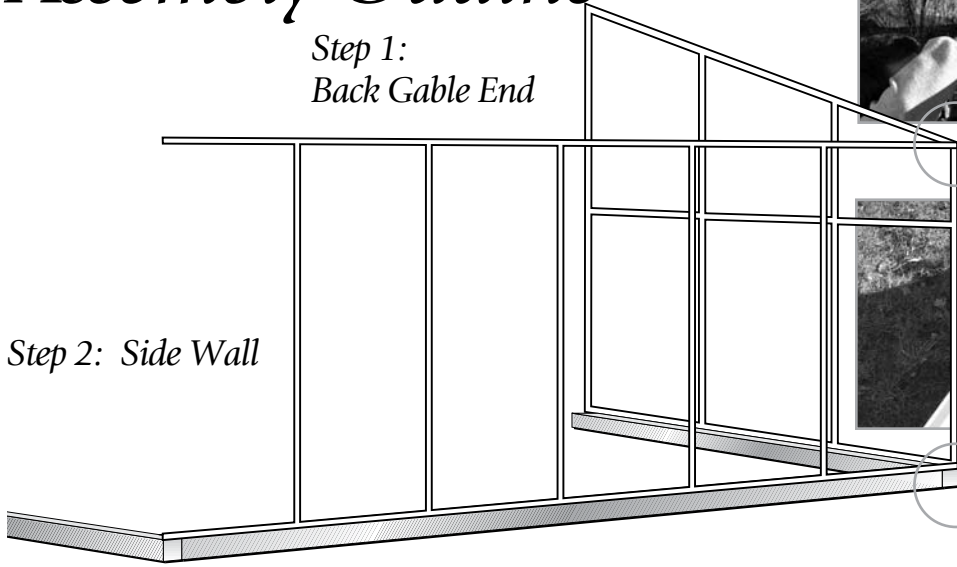

Step 3:
Front
Gable
End . . .

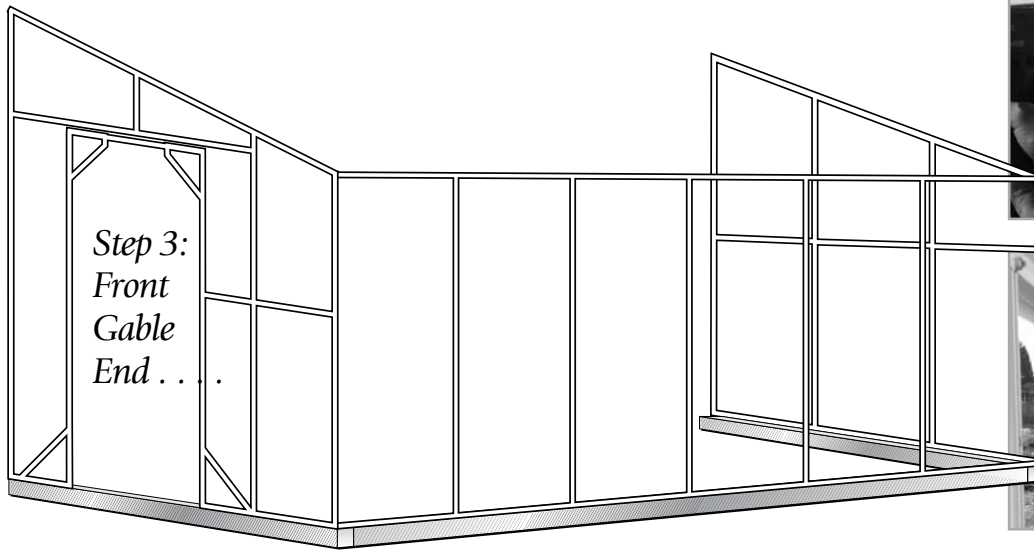

Step 4: Ridge

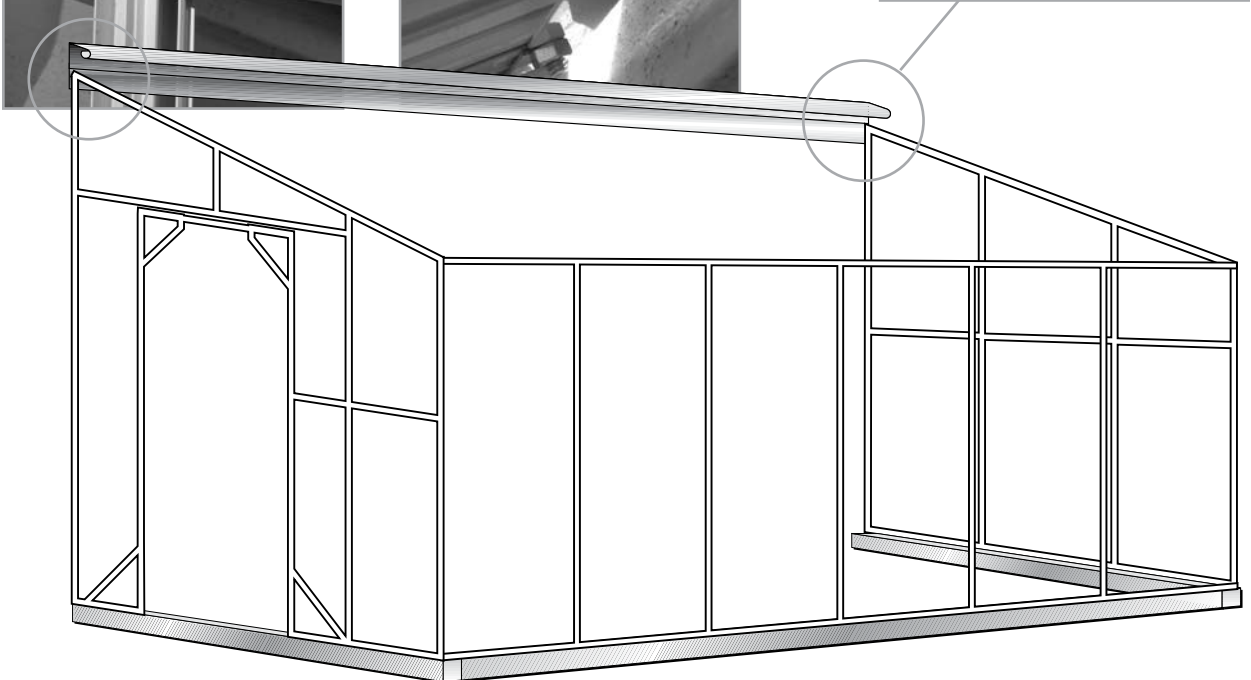

Step 5: Poly Bar with Vent Frame Sliders

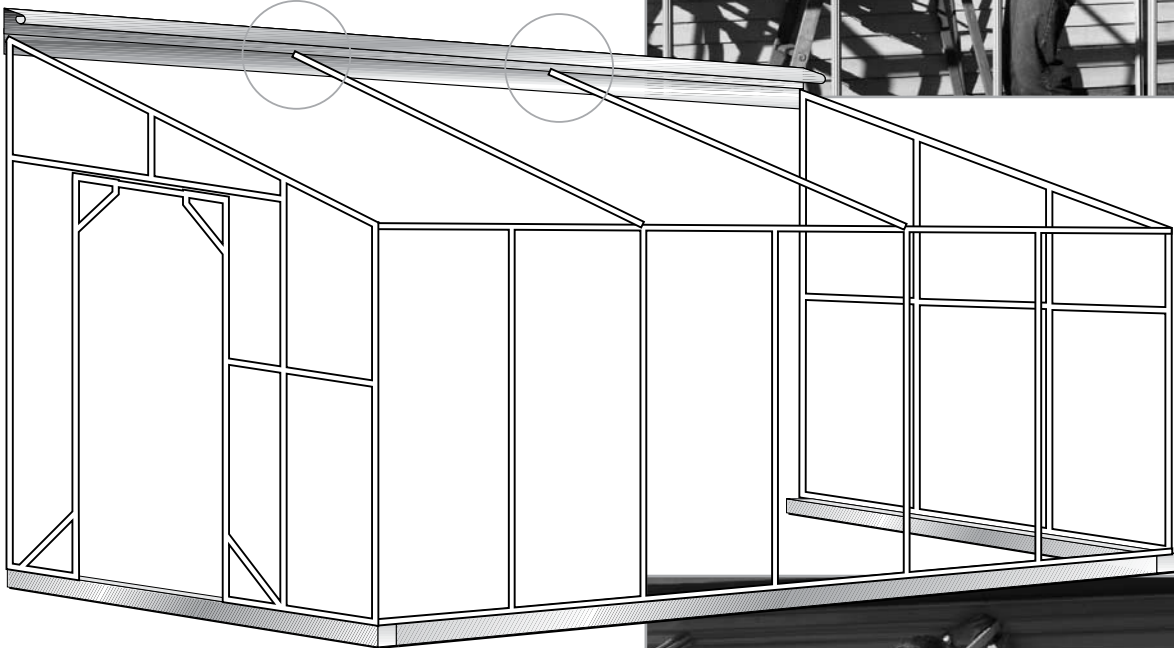

Step 6: Vent Frame Bottom

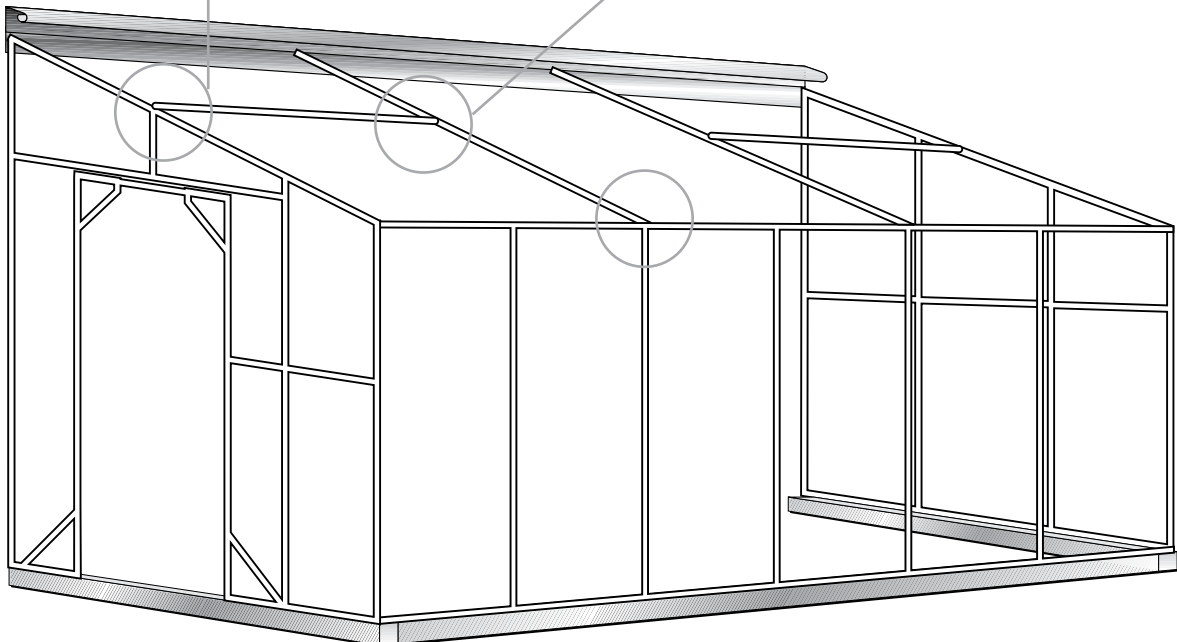

Step 7: Install All Remaining Poly Bars

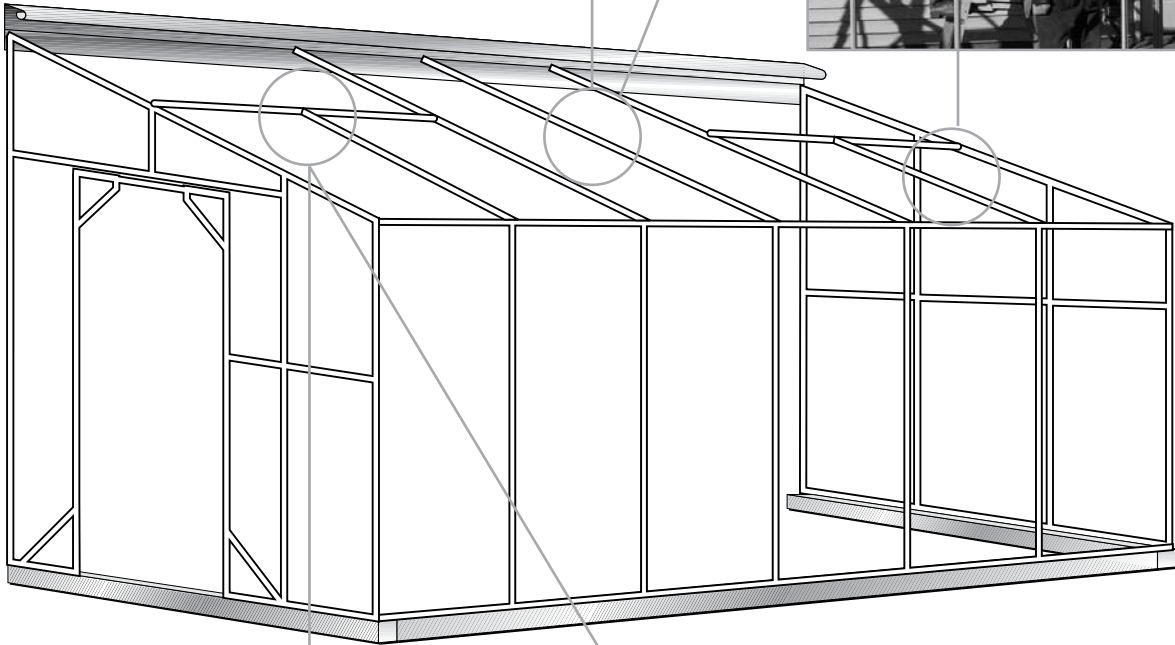

Step 8: Roof Purlin

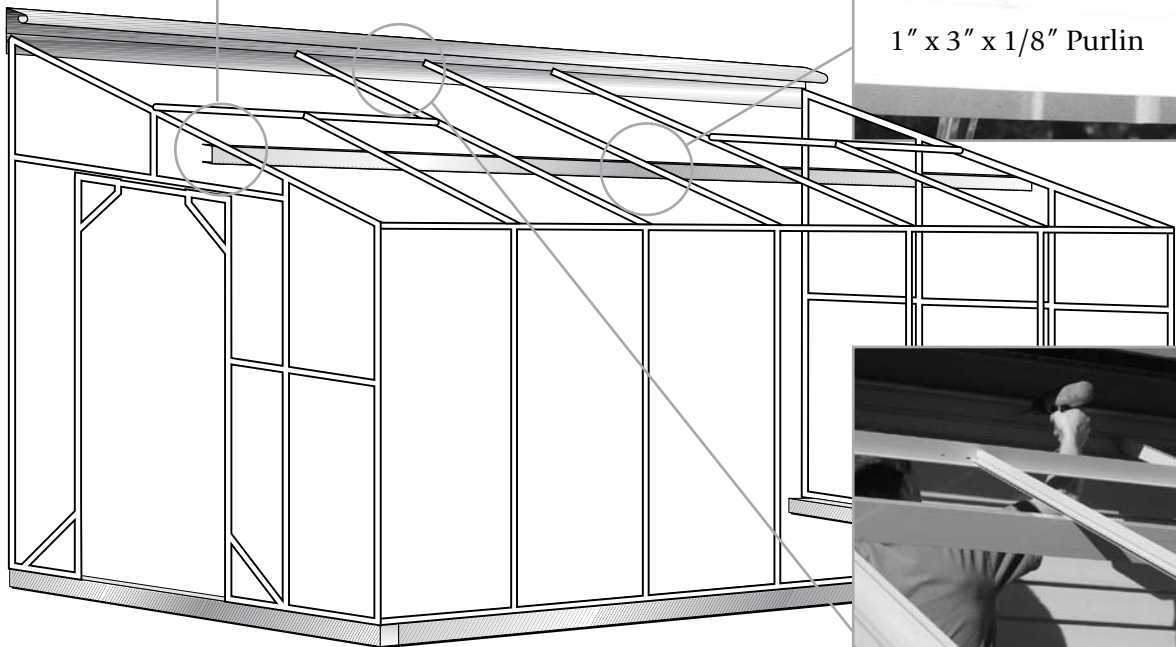
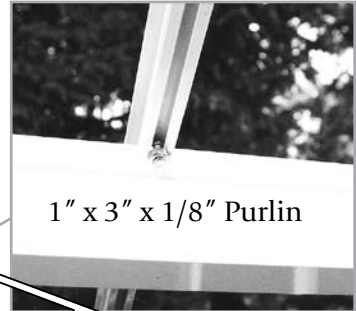

TAPING POLY BARS WITH FOAM

Tape all the aluminum polybars with 1/8" foam tape both sides. Take a roll of tape and start at one end and press on the bar. *Make sure that the aluminum is dry.* Slowly roll down the tape toward the outer edge and press it down at the same time (*See Pictures*). *Be careful* because sometimes the edge of the paper is quite sharp. Do not remove the paper until later.

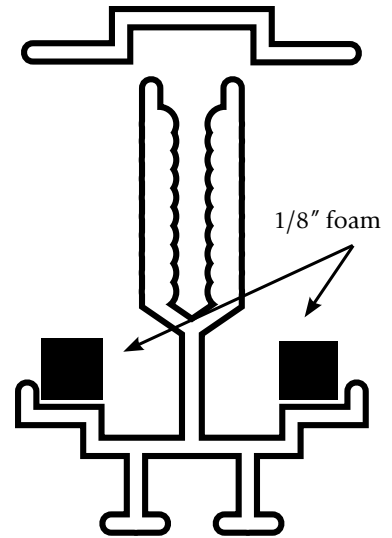

NOTE:

Taping the greenhouse can be done before you put the frame together.

If the weather is bad or dark outside, bring everything inside the garage and put the foam strips on the bars.

Make sure that the front / back / side / roof bars don't get mixed up, it would make it much harder to put it together.

Polycarbonate Panels & Cap Installation

GENERAL INFORMATION ABOUT HANDLING POLYCARBONATE

All polycarbonate sheets are covered with a thin sheet of plastic on both sides to prevent the sheets from becoming dirty and scratching during handling. One side is a clear plastic while the other side is blue or some other colour, depending on the manufacturer. This latter side should be installed so that it faces out. (**VERY IMPORTANT: Mark the sheet to indicate which side should face out.**)

ONLY THE BOTTOM ALUMINUM "H" that goes on the bottom end of the panels has drain holes.

FOIL TAPE

All five-wall panels should be taped on both ends (*keeps bugs out*). Take the panel, peel off the protective plastic (*make sure the outside corner is marked*). Or if you do it before installation you can just peel back the edges.

TOP OF THE PANEL uses a **SOLID** foil tape. Take off the backing of the tape and lay it on the end of the panel, press the edges down a little and move your hand along the panel to the end. Be careful when you slide your finger along the edge of the tape – it is sharp! When finished go back and bend the edge all the way over.

BOTTOM OF THE PANEL use the **VENTILATED TAPE** (*this tape has breathing / drain holes*). To cut this tape you will have to use a knife or scissors. Put it on the same way as solid tape.

(Do not lay your panels on the grass – it WILL burn your lawn.

Also do not store polycarbonate bundles outside.

Instead, store them in a cool dark place, such as a garage, until you are ready to use them.)

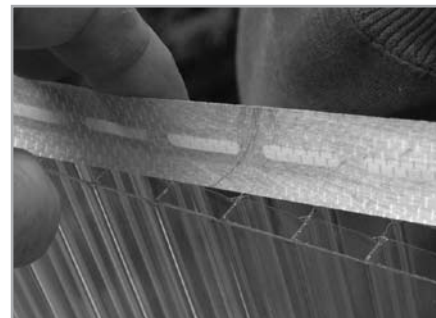
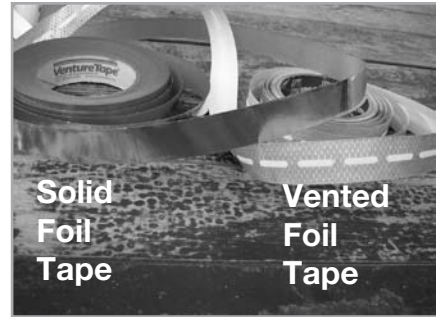

SIDEWALLS

Take side panels and peel back the protective plastic. Mark the outside top corner with a marker – apply foil tape, ventilated for the bottom / solid for the top (*you can do all the panels before hand or 1 at a time*). After the tape is applied, take an aluminum “H” and put it on the top first (*see Picture **A***). Remember to remove the paper from the foam strips. On a hot day lightly spray the foam with water so the polycarbonate sheets / glass will not stick when you install the panels. Next put one on the bottom (*put in setting blocks – donot cover drain holes – see Picture **B***) and push the panel up behind the gutter edge. Push the panel against the foam, make sure the Greenhouse is square and screw on the cap using #8 x 3/4” screws. If the weather is calm you can position all the panels first and then fasten all the caps.

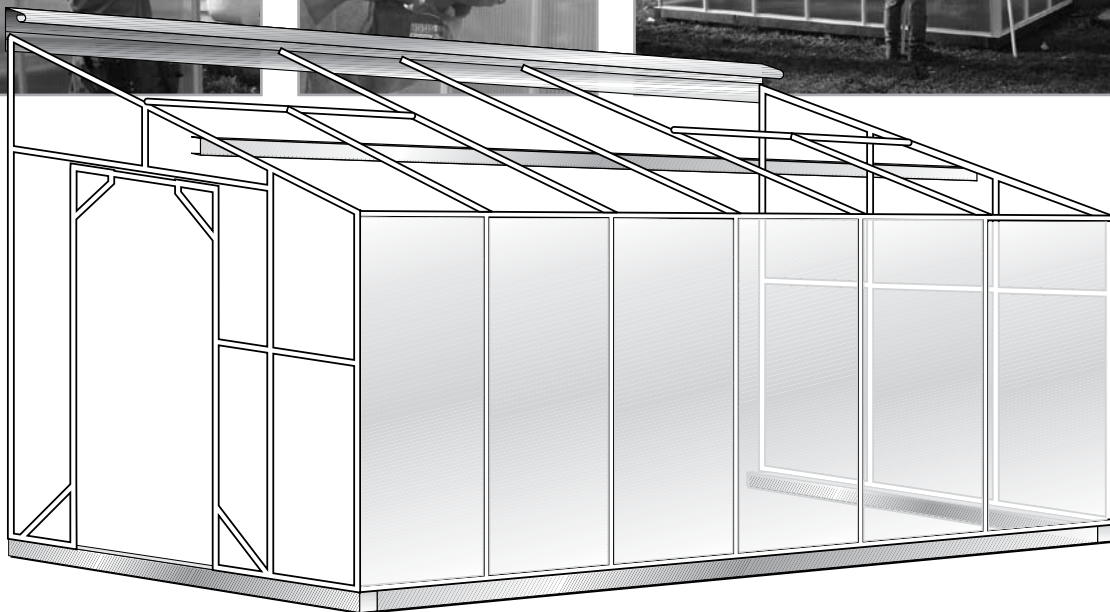
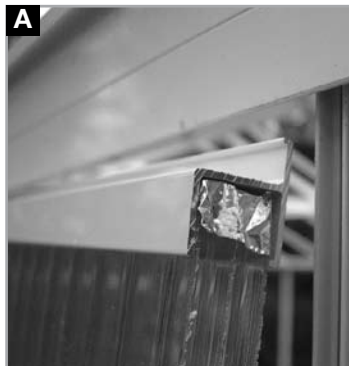
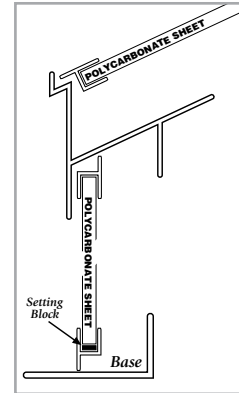

ROOF PANELS

Start off the same way as the end walls – peel back the protective coating, mark the corner with a marker so you know which side is out. Apply foil tape, ventilated for the bottom / solid for the top (*you can do all the panels before hand or 1 at a time*).

NOTE: *The panels below the vents have an aluminum "H" on BOTH ends - all long panels have an aluminum "H" on the bottom only.*

Take an aluminum "H" and put it on the bottom of the panel, do not forget the setting blocks (see pic on previous page), place setting blocks 6" from each end, push the panel up to the ridge and slide under the ridge flange (if the foam is sticking, spray it with a bit of water). Square the greenhouse up to the panel and fasten the cap using #8 x 3/4" screws. At this time you can seal the roof panels with clear silicone or wait until all the panels are place.

After the first panel is installed, continue with the second panel, etc.

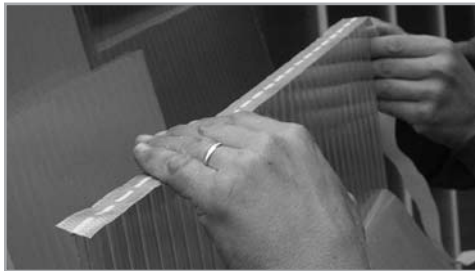

Seal outside after the panels are installed.

Polycarbonate Panel

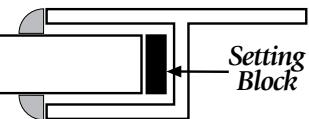

NOTE: *Seal the INSIDE of the "H" before installing the panel on the roof with silicone.*



END WALLS

Start off the same way as the sidewalls and roof panels – peel back the protective coating, mark the corner with a marker so you know which side is out. Apply foil tape, ventilated for the bottom / solid for the top (*you can do all the panels before hand or 1 at a time*).

Start with a corner first and work towards the centre. Put aluminum “H” on the bottom of panels (*drop in 2 setting blocks*). There is no aluminum “H” on the top of the sheets with the exception of the 2 panels *beside* the door.

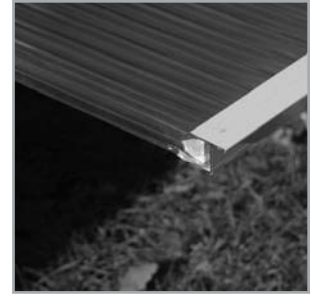

After the polycarbonate panels have been installed, take the round foam and fill the space between the panels and the aluminum



SEALING THE GREENHOUSE

When all the polycarbonate sheets are installed, take a tube of **CLEAR SILICONE SEALANT (A)** and seal all the panels that fit into the aluminum tracks on the top, the bottom, the inside and the outside. In this way, you can keep out most of the moisture from the end of the panels. If this sealing process is not done, water may sit in the bottom and fill the inside of the panels and grow algae.

1. Unscrew the plastic nozzle on the tube of silicone sealant.
2. Cut the top of the tube.
3. Screw on the plastic nozzle again.
4. Cut approximately 1/8" off the end of the plastic nozzle at a 30-degree angle.
5. Put the tube into the caulking gun. When using the gun, squeeze the handle slowly.
6. Wherever the polycarbonate sheets are sitting in a side / base track or aluminum "H". Also seal the inside of the "H" on the ends and sidewalls because greenhouse humidity runs down the panels into the "H" track.
7. Seal the vents before you slide them into place. Seal the places where the panes fit into the door frame bar and the "H" under the above door angle.

CAULKING (B) / SEALING (Do not get caulking on polycarbonate, use only silicone)

- Seal the door frame bar where the base/sill meets the door frame. (See **A**)
- Seal the inside of the base/sill along the perimeter of the foundation.
- Top or behind the ridge
- End brs against the wall

Do Not seal the "H" to the base! Any condensation in the polycarbonate needs to be allowed out.

(See additional pictures

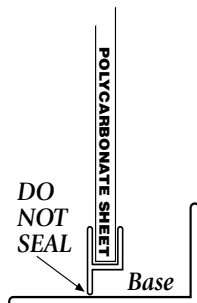

on next page)



Inside view



Outside View



SEALING THE GREENHOUSE *continued*

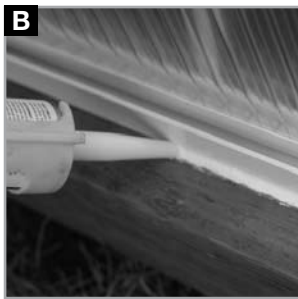
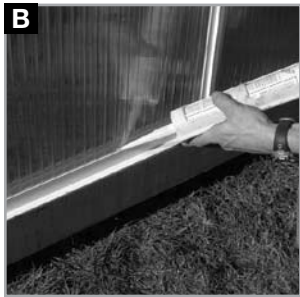
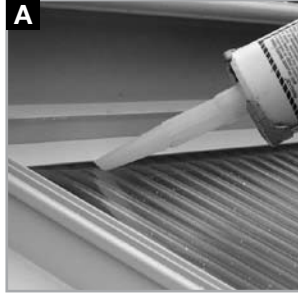
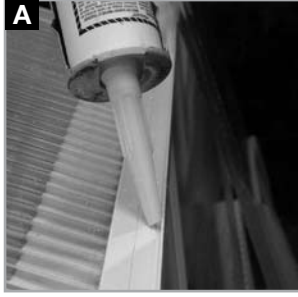

Door Installation

(Refer to the drawing.) Take the door and set it inside the door frame. Lift it up as high as possible on the hinge side and put the screws through the existing holes in the door frame. Now the door will hang by itself.

Remove the plastic clip from the "Z" bar and put one screw into the door frame to hold the "Z" bar. Open the door, take off the clips and put back the screws. Close the door and check that it is square. If the frame and the door are square, then fasten the "Z" bar to the frame. If not, move the "Z" bar up or down to square it. If this is not enough, loosen the bolts in the top plates and move the frame to make it square. When it is in place, tighten all the bolts.

Next install the door handle (see the instructions inside the box). To install the door catch angle, slide in two bolts into the back of the door frame. Bolt on a

small angle (provided with the door handle). Face the angle towards the door, line it up with the center of the door handle, and then tighten the two bolts (see picture to the right). Take the door catch out of the door handle box and screw it on. Close the door and adjust the door sweep at the bottom of the door to eliminate potential gaps.

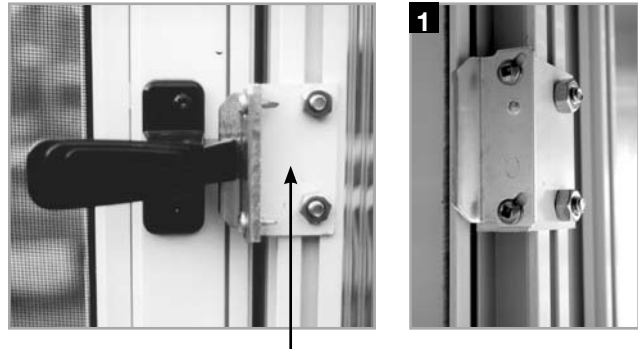

Door Catch Angle

NOTE: There are two types of manufactured doors. The door catch angle on the white door may have to be returned the opposite way as shown on Picture 1.

Run a bead of silicone under the angle above the door and against the door frame. Also silicone the poly beside the door to ensure an airtight seal.



Door Installation

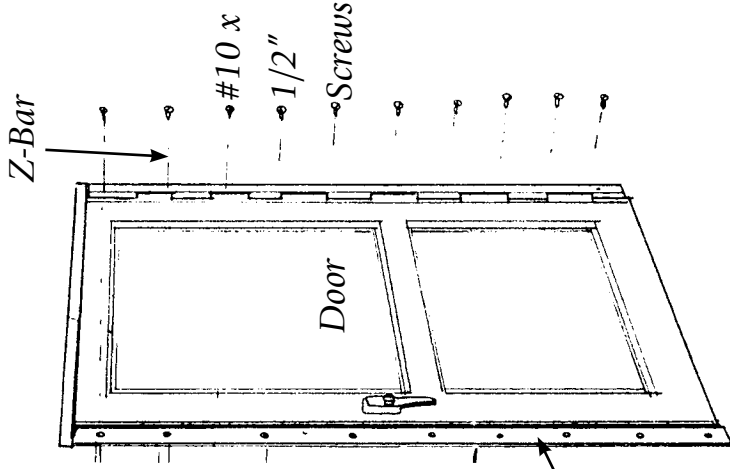
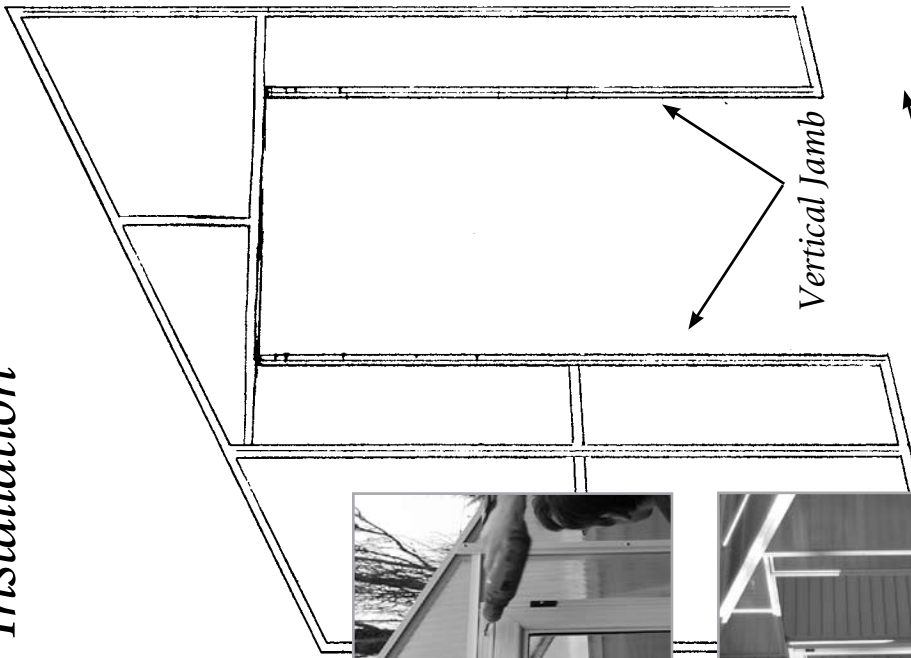

Plan View

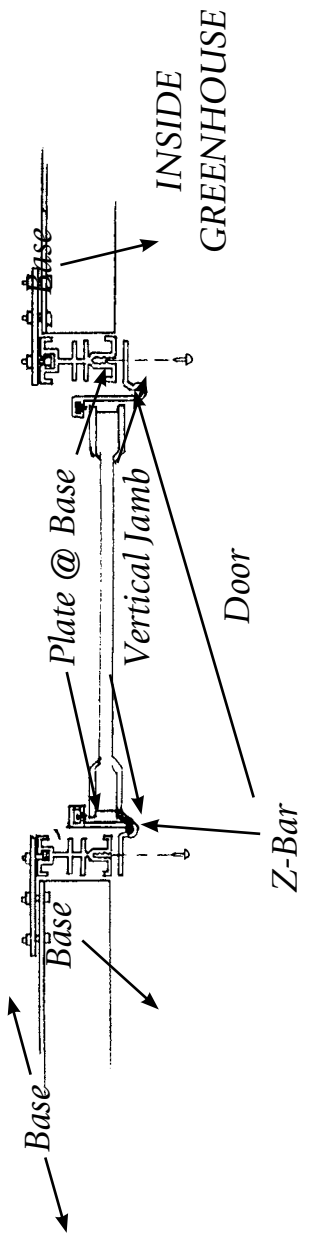

VENT ASSEMBLY (SEE PICTURES & PAGE 36 & 37)

1. Lay down the gutter with the punches facing up towards you.
2. Polybars with sliders on are for the end. Lay them down with the bolt slot facing up.
3. Hinge with punches facing up towards you.
4. Slide the bolts into both ends of the end bar. Take the gutter and line up the bolt with the 1st punch, slide the bolt down and tighten it. Do the same with the hinge, other side and center bar. Make sure that the polybars are tightly fitted to the gutter and hinge after vent assembled.
5. Turn it over and put a square where the polycarbonate goes. Push / pull to square it up.
6. Put 1/8" foam on the polybars.
7. Take polycarbonate panel, remove the film (*clear inside*) and slide it into the hinge track. Before you do this; remove the paper from the foam tape and lightly spray with water so that it doesn't stick. Lay it on the foam and slide it into the hinge (top) section and then down into the gutter track. Do the same with the next piece.
8. Take the caps and lay them on the bars, center them, fasten with 1/2" screws.
9. Take the silicone gun and seal where the sheets slide into the track. *Inside and out.*
10. 3/4" screw through hinge and gutter into glass bars.

VENT INSTALLATION

Take vent and slide it in the end of the ridge **A** (*you will have to remove a the screw in the ridge*). Then push it into place and put the screw back in **B**. Now attach an automatic opener.

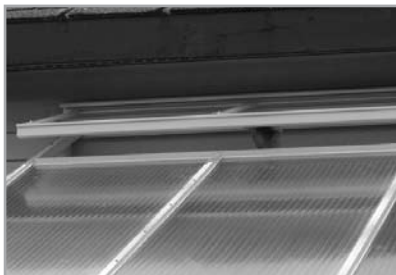

Vent Opener

INSTALLING THE BAYLISS AUTOMATIC VENT OPENERS

Detailed instructions are included in the box with the control (there are a few extra parts).

Use #10 stainless steel screws to fasten the Bayliss and the vent sill ① and the ② vent

All holes are already drilled.

After the Bayliss is fastened in place, install the threaded adjuster into the swivel block. This is made easier by lifting the vent with one hand until the piston rod only projects 1/2" through the swivel block.

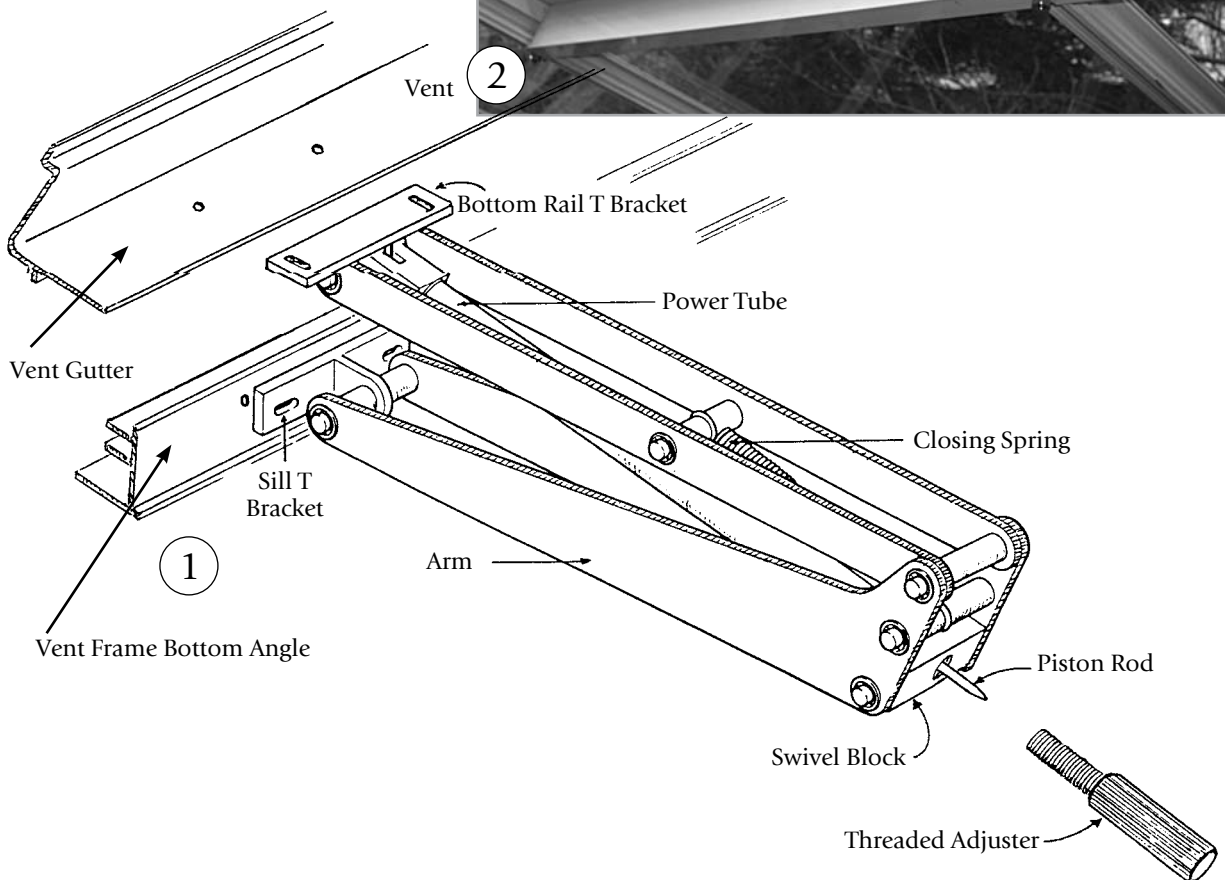

Greenhouse Roof Vent Details

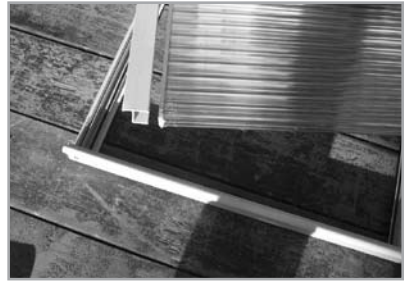
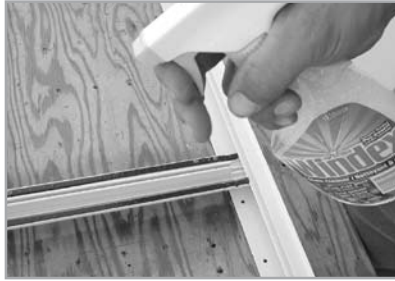
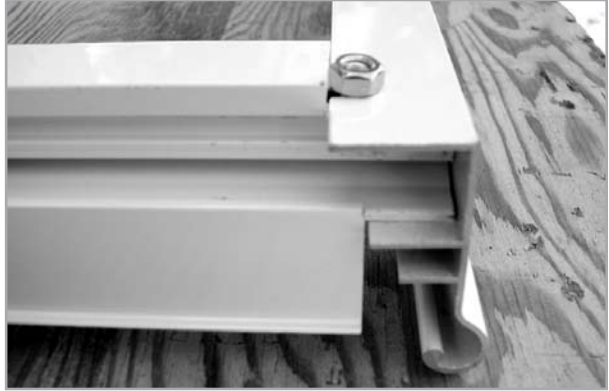

5-Wall Polycarbonate Roof Vent

5 WALL POLYCARBONATE ROOF VENT

- ALL BOLTS SHOWN ARE $\frac{3}{8}$ " LONG
- ALL FACE CAP SCREWS ARE $\frac{3}{4}$ " LONG
- GUTTER END SCREWS ARE $\frac{3}{4}$ " LONG
- VENT HINGE END SCREWS ARE 1" LONG

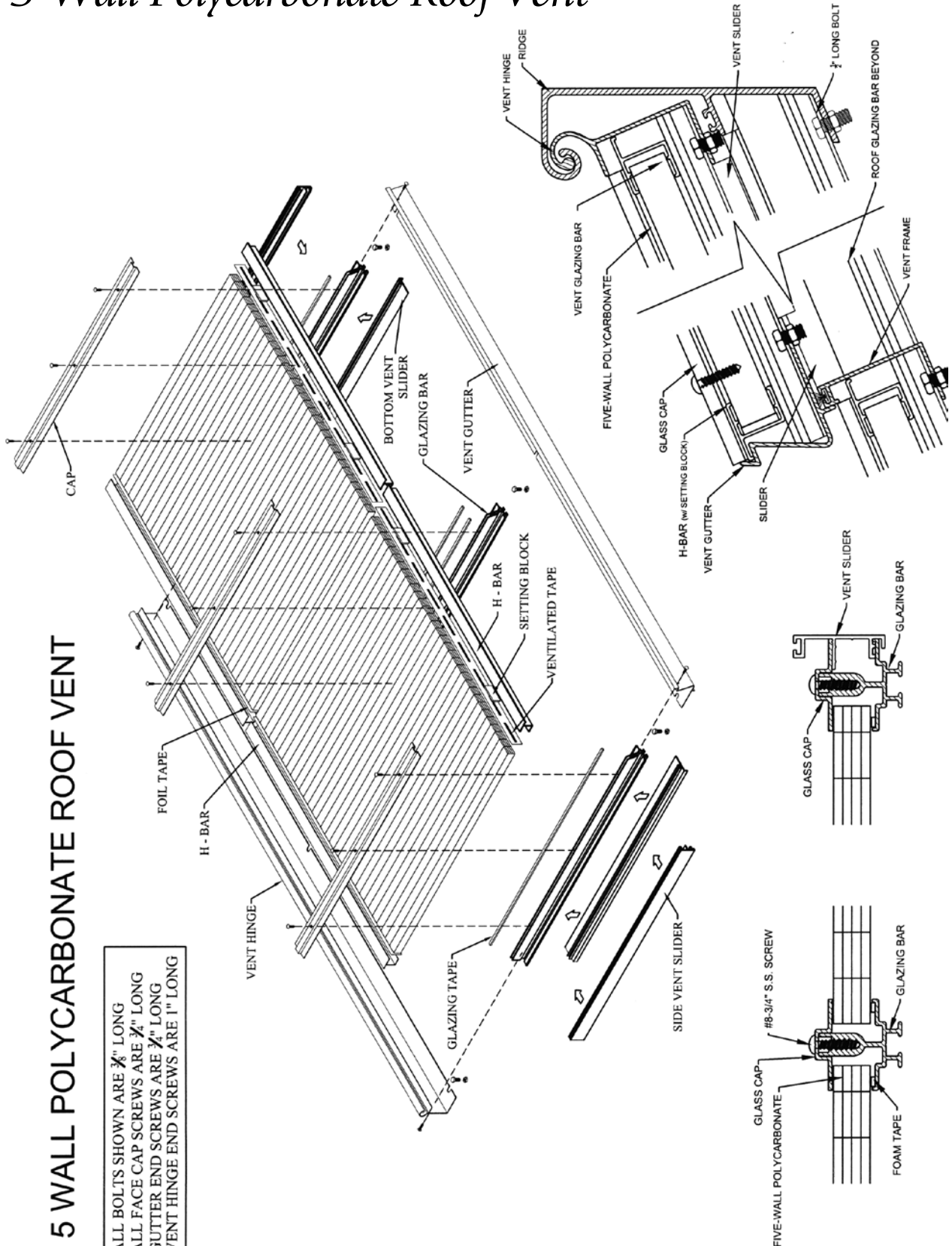



General Notes After Installation:

- If the gutter fills up with water, drill a few small weep holes (*check gutter for level*).
- Small beads of silicon will not adhere unless they are molded into corners with a moist fingertip.
- Adjusting the door can be done by loosening up the bolts in door plates and/or putting shims under the door frame.
- When vents hang up on top of vent frame – check the vent bolts (*in the hinge*) to make sure that the bolts do not hit the ridge when closed.
- After the greenhouse has been up for more than 6 months (*the greenhouse will have settled*) recheck the screws and bolts to ensure everything is tight.

Appendix A – Motorized Intake Shutter

NOTE: Installation of the intake shutter is the same for a glass or polycarbonate greenhouse

- Slide bolts in through notches provided (a small piece of foam stuffed in track under bolt keeps it from sliding down).
- Ensure the blades open with flaps facing down.
- Install glass or polycarbonate on frame of intake shutter.
- Seal around the intake shutter after glass or polycarbonate is installed.

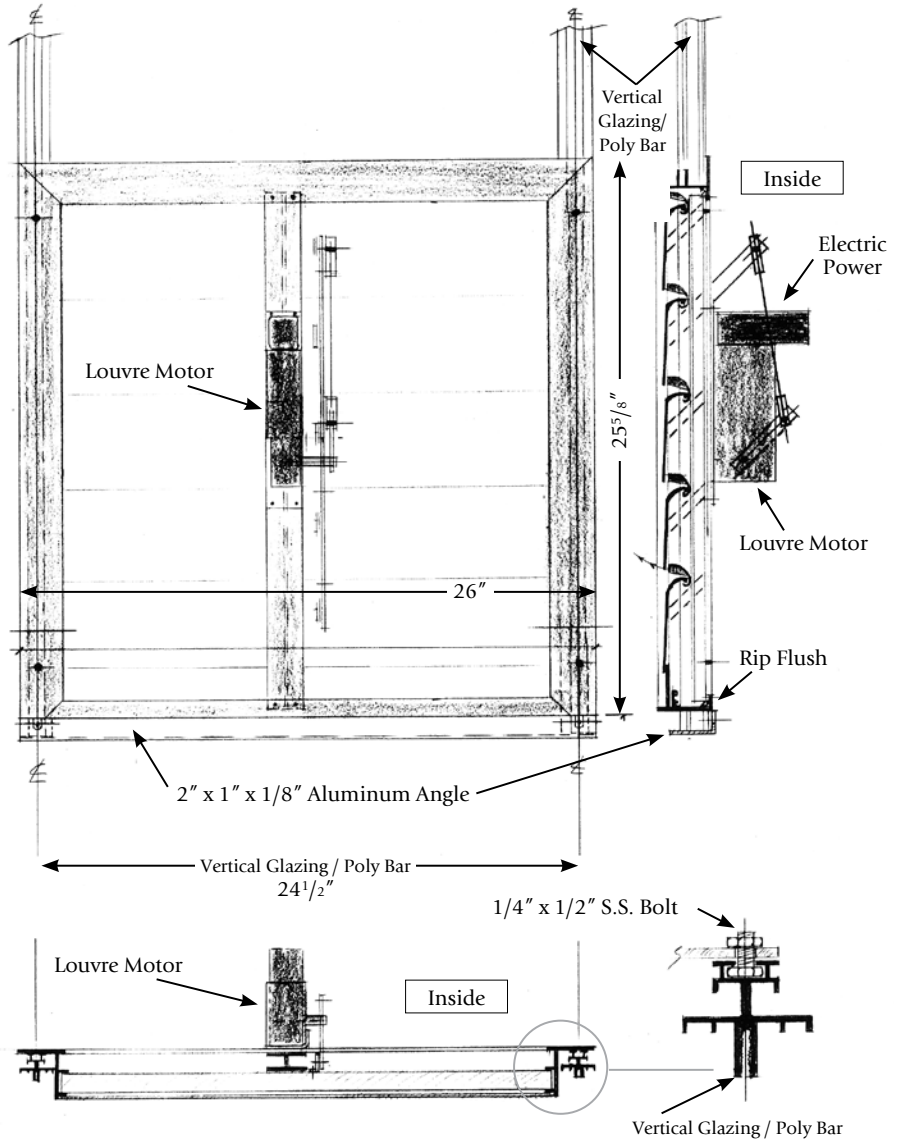

Inside View



Appendix B – Exhaust Fans

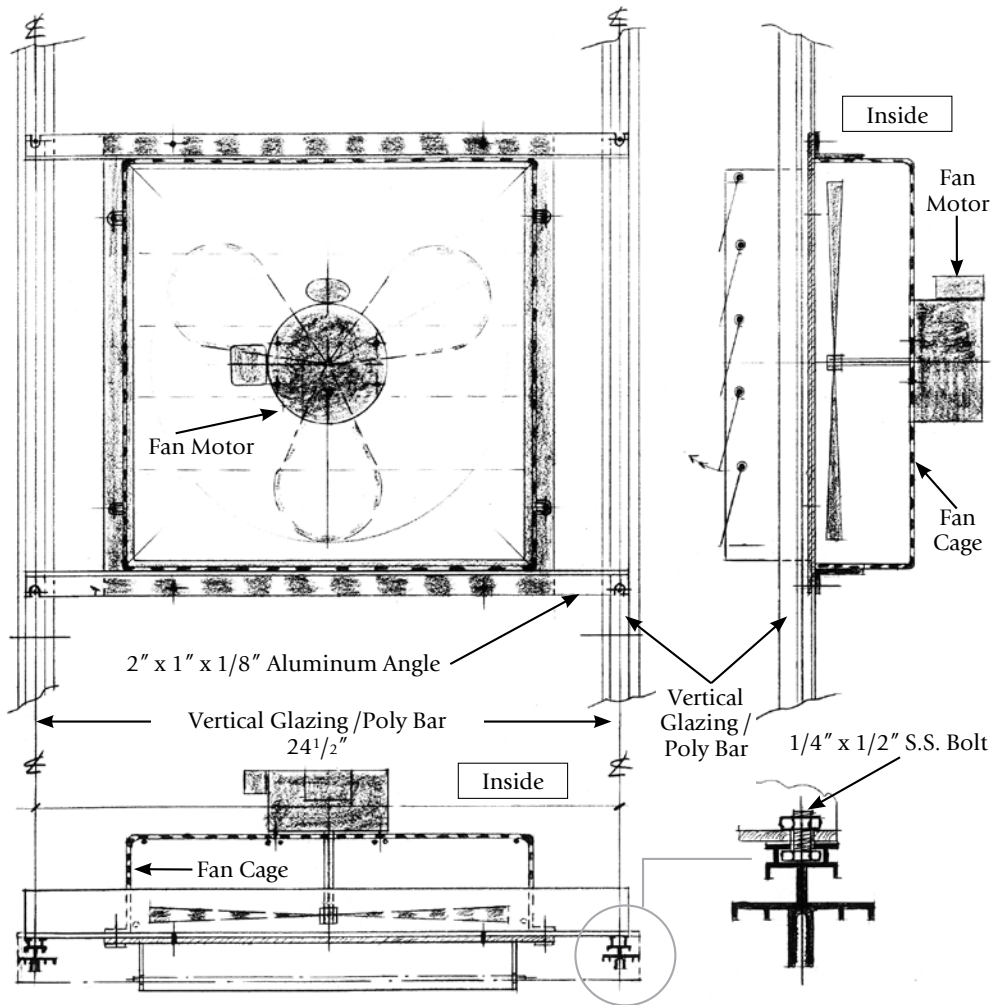

- Slide bolts into vertical bars beside fan bottom.
- Temporarily tighten.
- Insert fan in square cutout of acrylic piece.
- Slide bolts into slots on angle and tighten
- Seal around shutter on outside.



Appendix C – Side Vent

GLASS OR POLYCARBONATE SIDE VENT ASSEMBLY

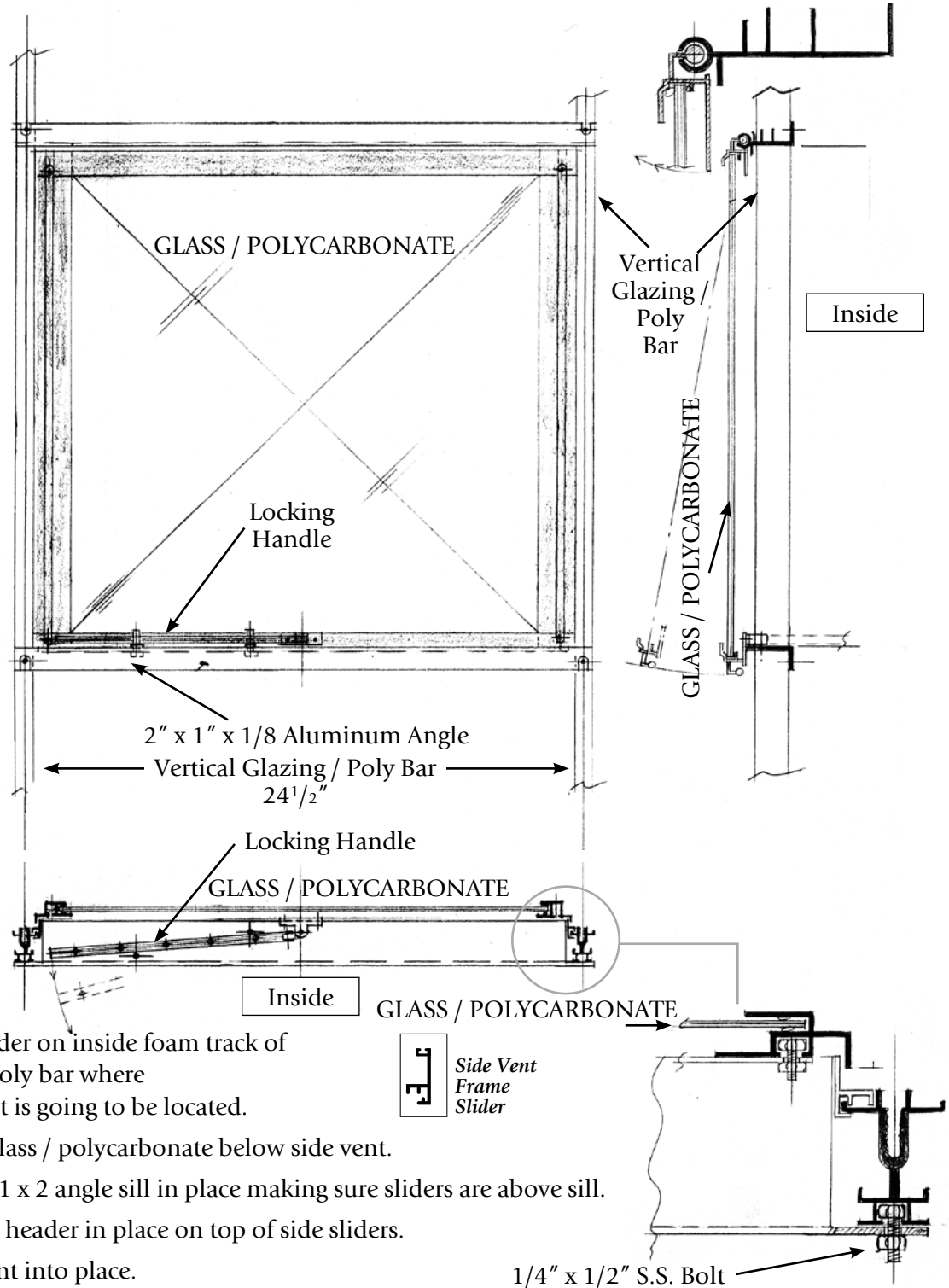

1. Slide slider on inside foam track of glass / poly bar where side vent is going to be located.
2. Install glass / polycarbonate below side vent.
3. Bolt on 1 x 2 angle sill in place making sure sliders are above sill.
4. Bolt top header in place on top of side sliders.
5. Slide vent into place.
6. Install automatic or manual opener.

Appendix C – Side Vent CONTINUED

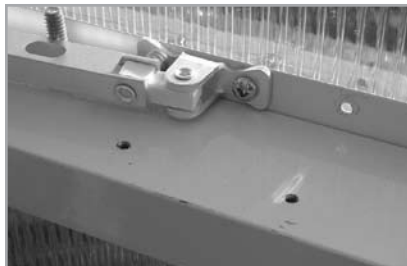
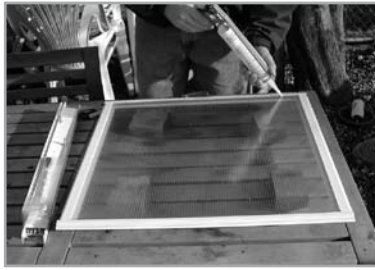
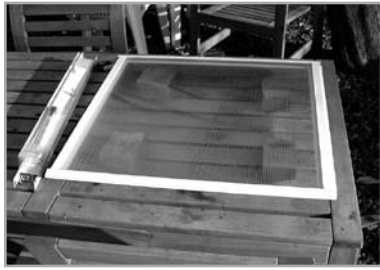

Appendix D – Glass Louvre

GLASS OR POLYCARBONATE GLASS LOUVRE ASSEMBLY



Appendix E – Perlin Installation

Larger greenhouses have perlin to increase strenght in roof structures. A perlin can be a heavy or light channel. It usually sits on top of a truss and is bolted to the roofbars in the centre of he roof.

Heavy perlin (*at least 1/4" thick*) requires 1/4" x 3/4" bolts. Smaller greenhouses use a light channel – bolts used are the same as the greenhouse bolts, 1/4" x 1/2."

Installation of a perlin is a simple matter of sliding the bolts into the roof bars and feasting the perlin (*see photos*).

Bolt Perlin with the open side facing up if you wish to use it for hanging baskets.

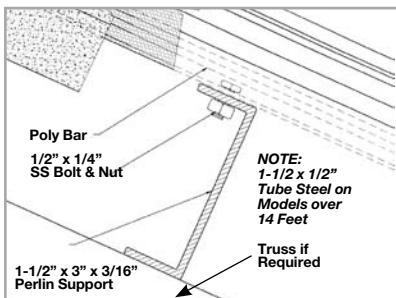
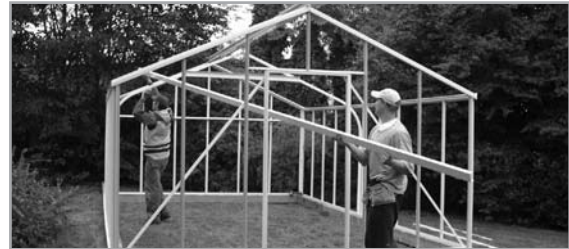
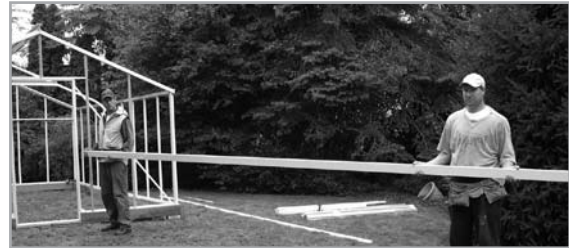

Appendix F – Greenhouse Bench

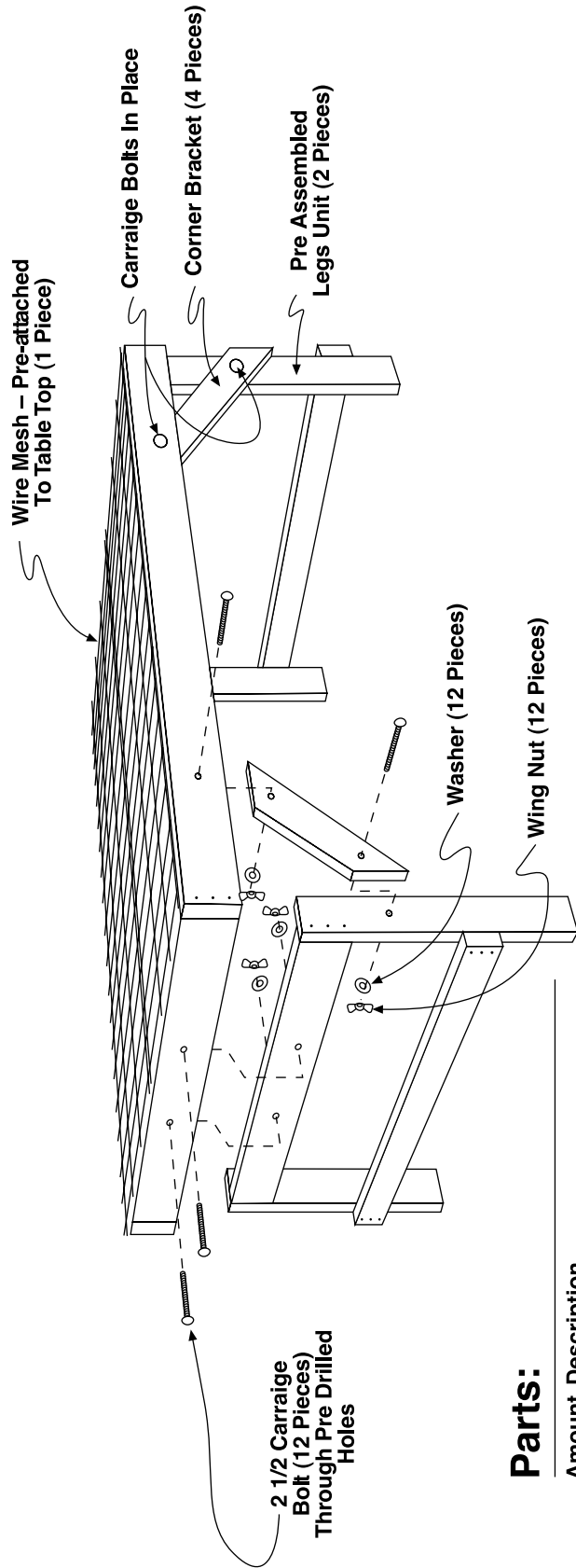

Parts:

Amount Description

- 1 – Table Top = W/ Pre-attached Wire Mesh
Plastic Coated W/Guide Holes
- 2 – Leg Units = Pre-assembled W/ Guide Holes
- 4 – Corner Brackets = W/ Guide Holes
- 1 Bag – Contains: 12 – 2 1/2 Carrage Bolts
12 – Washers
12 – Wing Nuts

Appendix G – Roof Vent Screen

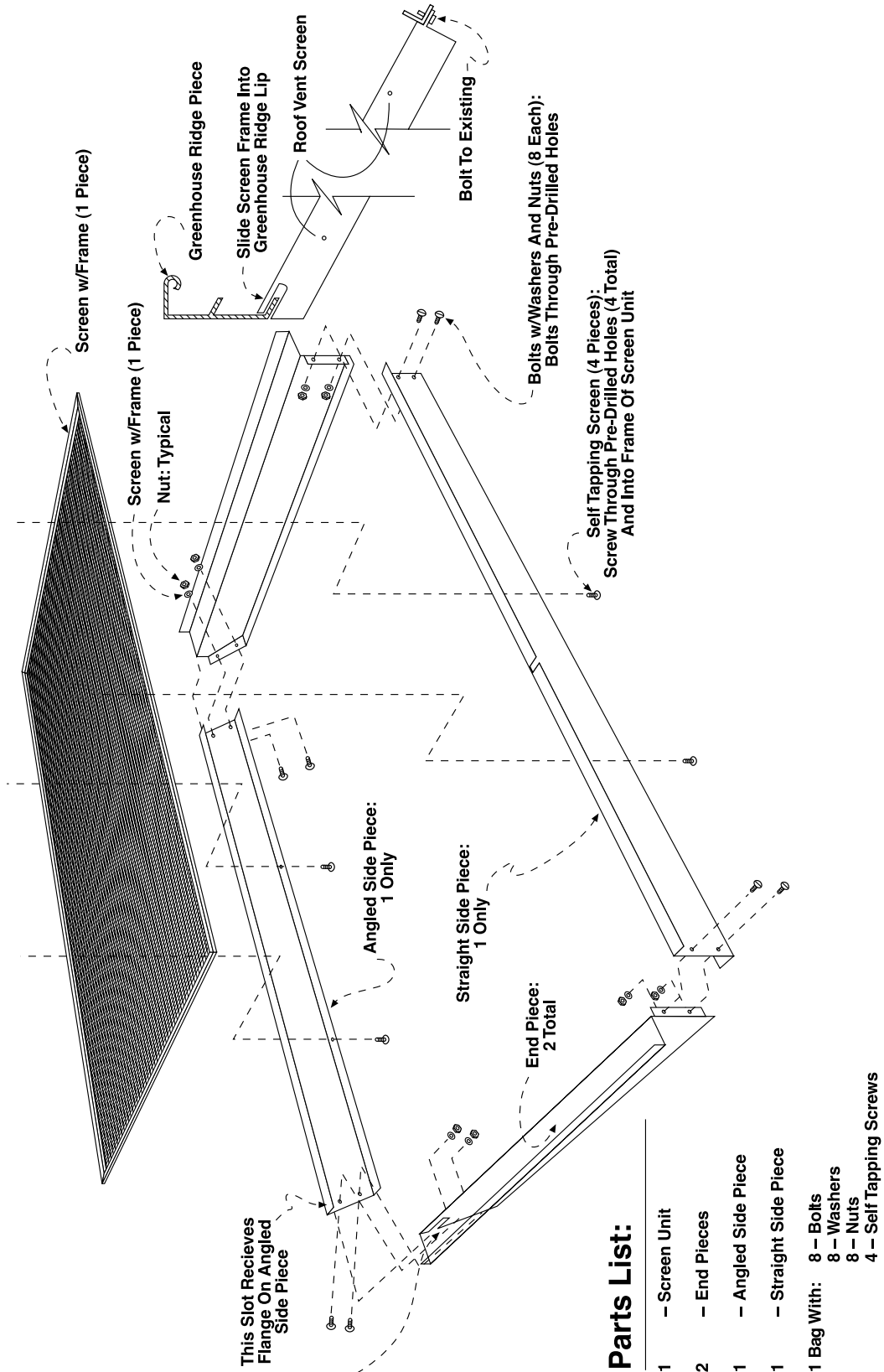

Appendix H – Side Vent Screen

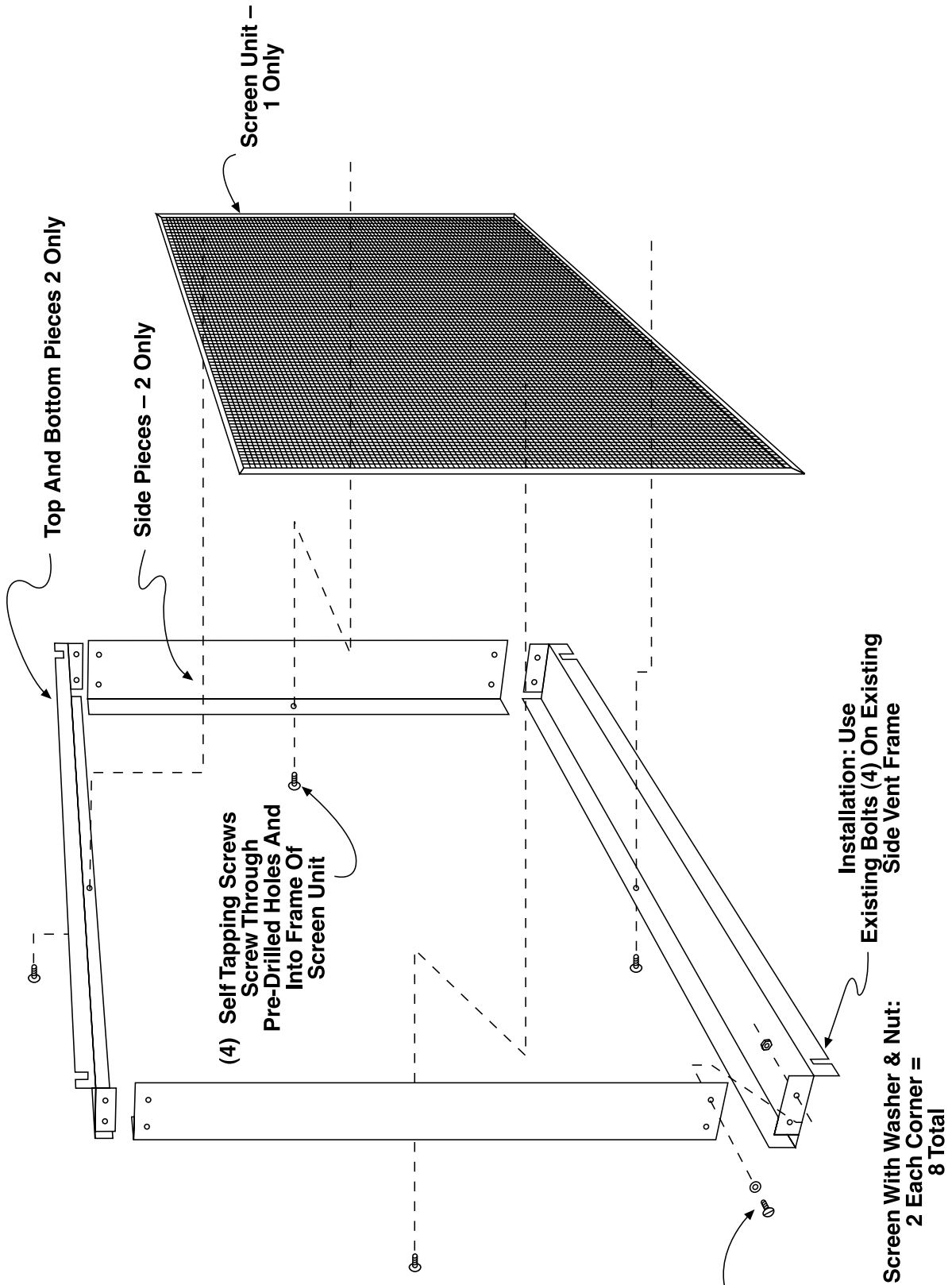

Appendix I – Wire Shelving

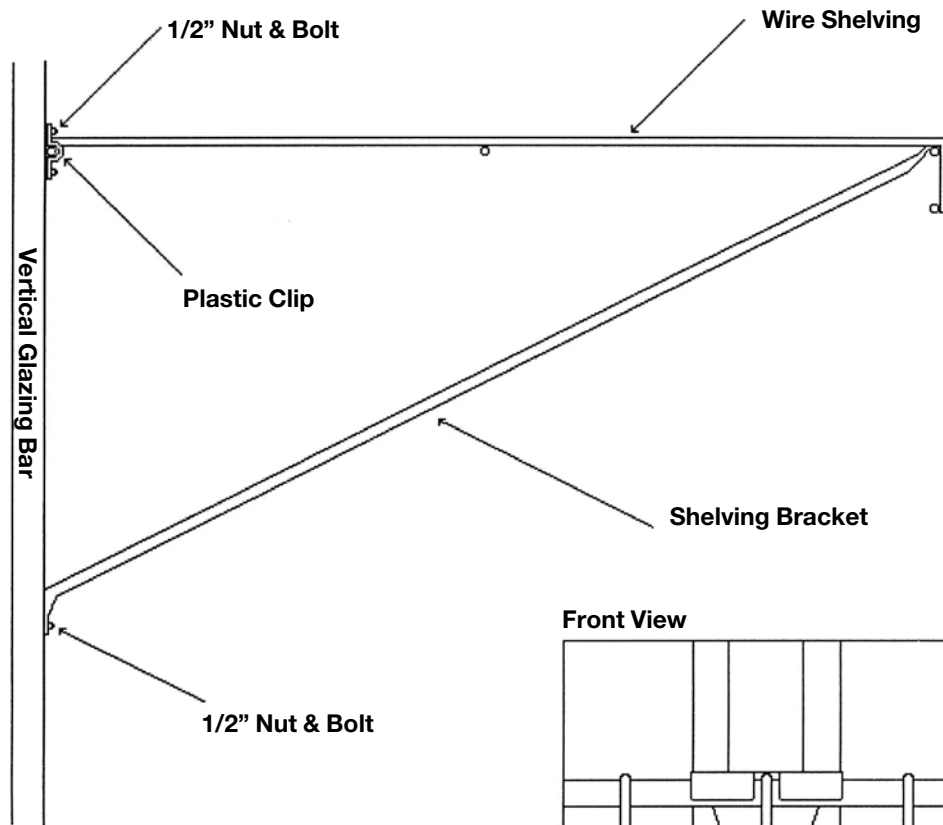

Front View

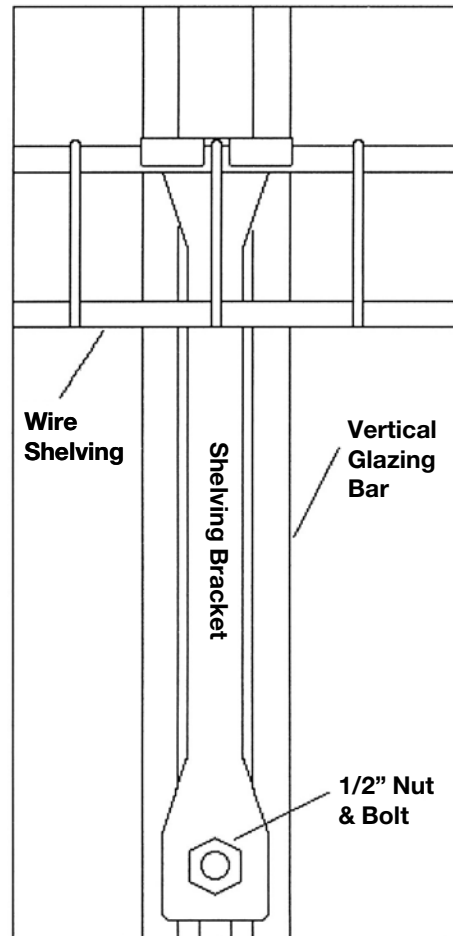

Front View: Plastic Clip

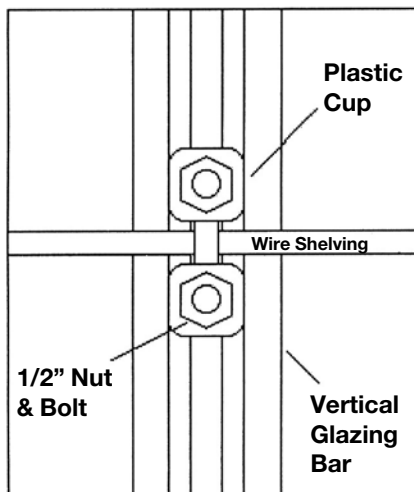

Miscellaneous Assembly Details – 1

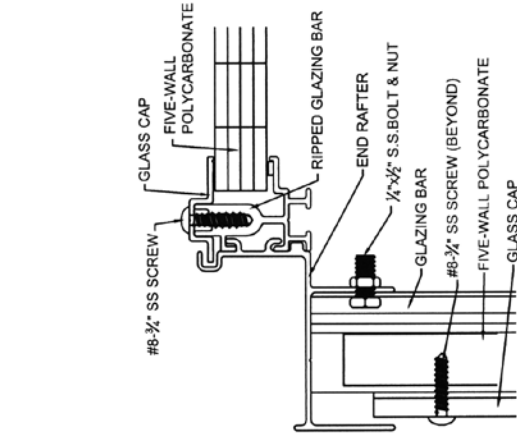

END RAFTER SECTION
Scale: 6" = 1'-0"

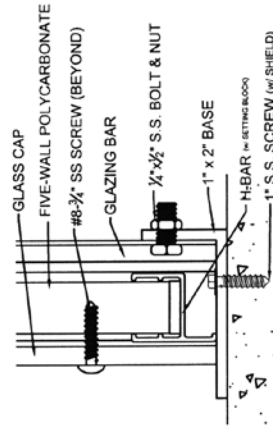

BASE SECTION
Scale: 6" = 1'-0"

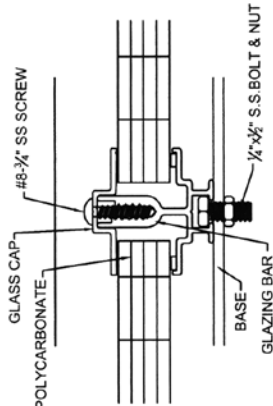

GLAZING BAR
Scale: 6" = 1'-0"

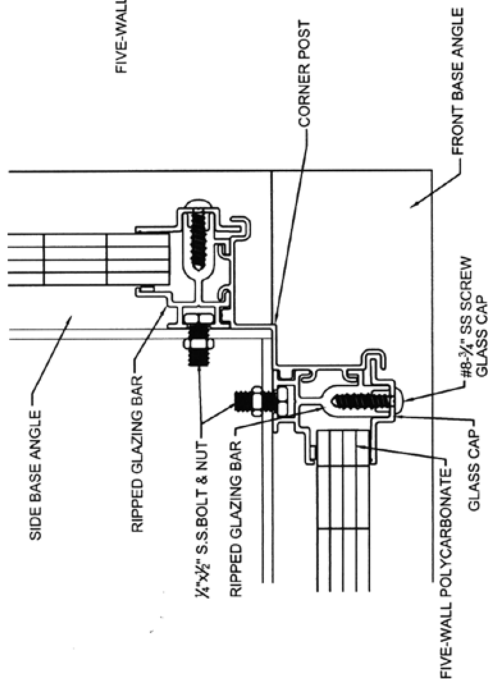

CORNER POST DETAIL
Scale: 6" = 1'-0"

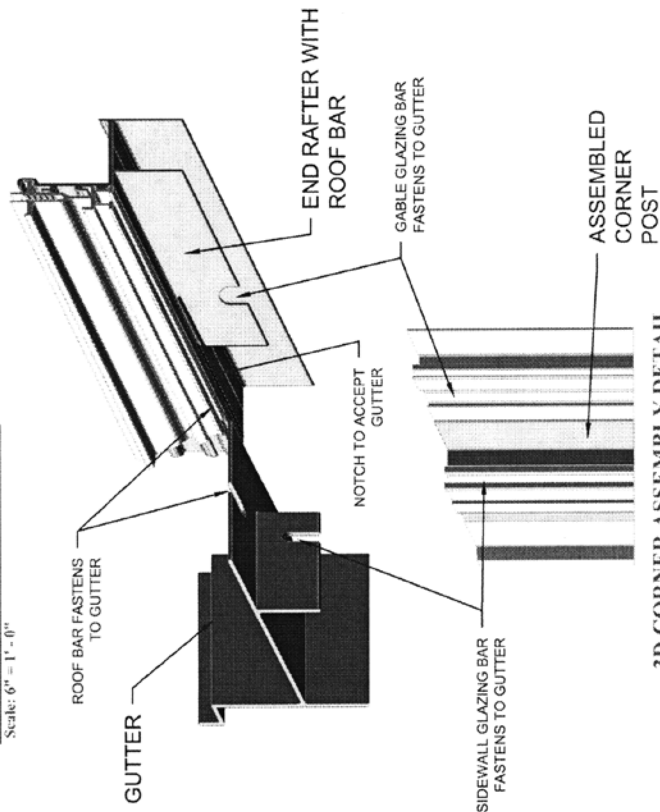

3D CORNER ASSEMBLY DETAIL
Scale: NTS



At this point, stand back and enjoy your workmanship.

*Your Cross Country Triple Wall Lean To Greenhouse
should now be closed in and ready for use.*

Congratulations!