

# *Traditional Series* Straight Lean To

Model TLT612SG

---

## GREENHOUSE INSTRUCTIONS

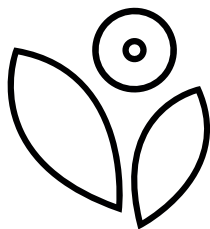

Greenhouse Style  
CORPORATION

Telephone: 1-800-665-2124 | Fax: 1-888-273-1251

[www.greenhousetyle.com](http://www.greenhousetyle.com) • [info@greenhousetyle.com](mailto:info@greenhousetyle.com)

# Contents

Foreword . . . . .	2
User Notes . . . . .	2
List of Drawings . . . . .	3
Traditional Straight Series Component List . . . . .	4
Foundations . . . . .	5
<b>Assembly of the Aluminum Frame</b>	
A. Back Gable-End Assembly . . . . .	8
B. Front Gable-End Assembly With Door . . . . .	11
C. Sidewall Assembly . . . . .	14
<b>Aluminum Frame Installation</b>	
1. Side Wall To Back Gable End. . . . .	15
2. Side Wall To Front Gable End . . . . .	15
3. Ridge . . . . .	16
4. Truss Assembly Installation (If Necessary) . . . . .	See Appendix A
5. Glass Bar With Sliders (#1 or #2) . . . . .	16
6. Vent Frame Angle . . . . .	16
7. Glass Bars . . . . .	16
Taping Glass Bars with Foam. . . . .	17
8. Fastening The Base/Sill To The Foundation . . . . .	17
9. Side Vents, Intake Shutter and Exhaust Fan Installation (if necessary). . . . .	See Appendices B through E
<b>Glass and Cap Installation</b>	
General Information. . . . .	25
10. Side Glass . . . . .	25
11. Roof Glass . . . . .	27
12. End Walls Glass. . . . .	28
13. Sealing The Greenhouse. . . . .	29
<b>Door And Vent Installation</b>	
14. Door Installation . . . . .	30
15. Vent Installation . . . . .	32
16. Vent Assembly . . . . .	33

# Foreword

Your Traditional greenhouse is designed and constructed to the highest engineering standards and provides structural strength and maintenance-free service for year-round gardening pleasure.

The Traditional greenhouse must be built upon a firm, level surface. The greenhouse foundation or sill can be made from pre-treated timbers, concrete or bricks. Whatever your choice of material, the base must be square and level.

When selecting a site for your greenhouse, keep in mind that a flat, level site is essential so that the greenhouse can be easily installed and the complete structure is stable and secure. If possible, choose a site with proper water drainage.

Locating the greenhouse in a north-south position is most suitable for raising summer and autumn crops since the sun's rays will be on the greenhouse from daybreak until sunset. An east-west position is ideal for early spring and winter crops since the winter months, with shorter daylight hours, still allow six hours of light exposure to the greenhouse.

Try to locate your greenhouse for easy access, especially to the necessary power and water that is required for greenhouse gardening.

Please watch the enclosed video and follow the steps in this manual for your greenhouse installation. *Remember, if all else fails, read the instructions.*

## User Notes

The Traditional greenhouse structure has been designed to withstand extreme weather conditions such as high winds and accumulated snowfall. Hanging baskets and sidewall shelving can also be attached to its sturdy frame. The greenhouse design also makes it possible to add extra sections at a later date.

Once a year the greenhouse needs to be completely washed inside and out. You should do this task when your greenhouse contains the least number of plants, generally just before the garden plants are brought in for wintering over. A recommended cleaning solution is a mixture of hot water with a disinfectant such as Lysol or Pinesol. Any benches, shelving, plastic trays, pots and baskets should also be cleaned thoroughly. *Prevention is the best known method for controlling pests and diseases in the greenhouse.*

***PLEASE NOTE: The Illustrations found in this manual may not be specific to your greenhouse, however the detail of aluminum shapes are all consistent. The user notes are a generic instruction for all Traditional Series Greenhouses – assembly instructions are common, only the sizes number of pieces and sizes vary.***

# List of Drawings

Foundation Styles . . . . .	5
Back Gable End Inside View <i>Picture</i> . . . . .	7
Back Gable End Inside View <i>Detail Line Sketch 1 – 5</i> . . . . .	8
Front Gable End <i>Detail Line Sketch 1 – 7</i> . . . . .	10
Front Gable End Inside View <i>Picture</i> . . . . .	11
Sidewall Inside View . . . . .	15
Assembly Outline <i>Steps 1 – 3</i> . . . . .	16
<i>Steps 4 – 7</i> . . . . .	17
<i>Steps 8 – 12</i> . . . . .	18
<i>Door Installation</i> . . . . .	31
Vent Assembly - <i>Exploded View</i> . . . . .	34
Vent Detail. . . . .	35
Truss Assembly . . . . .	Appendix A
Intake Shutter . . . . .	Appendix B
Exhaust Fan . . . . .	Appendix C
Side Vent . . . . .	Appendix D
Glass Louvre . . . . .	Appendix E
Polycarbonate Roof Panels Installation. . . . .	Appendix F
Perlin Installation . . . . .	Appendix G
Greenhouse Bench . . . . .	Appendix H
Roof Vent Screen . . . . .	Appendix I
Side Vent Screen . . . . .	Appendix J
Wire Shelving . . . . .	Appendix K
Miscellaneous Assembly Details: 1& 2	

# Traditional Component List

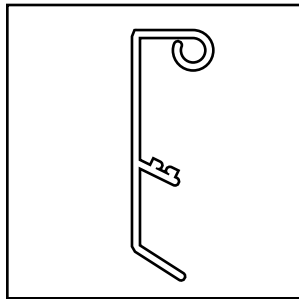

Ridge

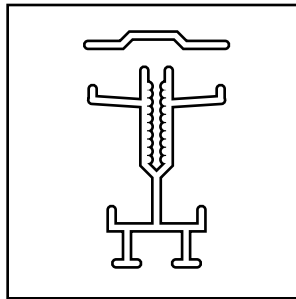

Glass Cap & Glass Bar

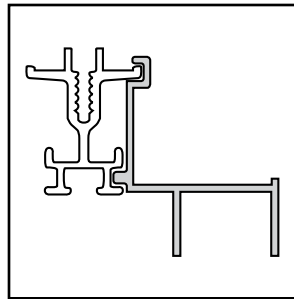

End Rafter

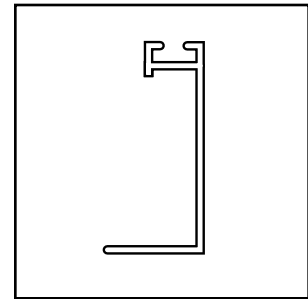

Ventframe Bottom

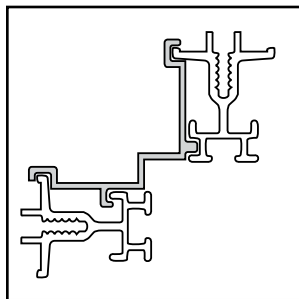

Corner Post

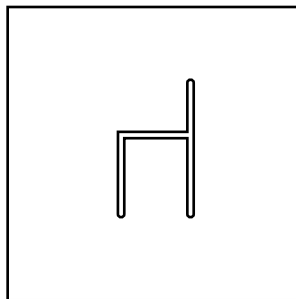

Plastic H

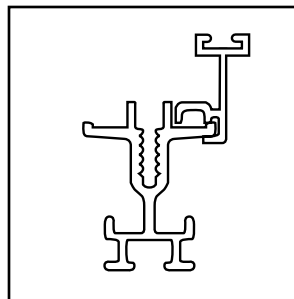

Vent Frame Sides

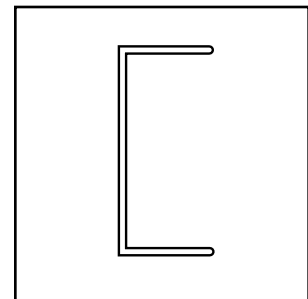

Perlin (if required)

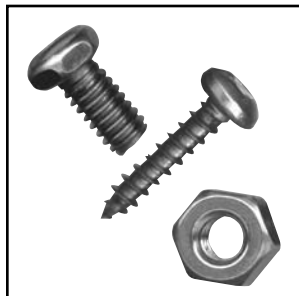

Screws and Bolts

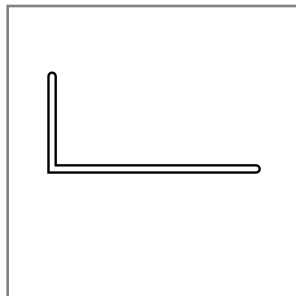

Base / Sill

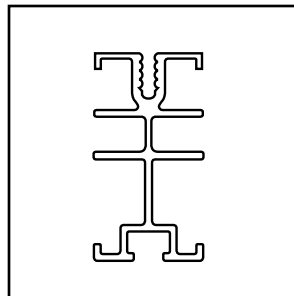

Door Frame

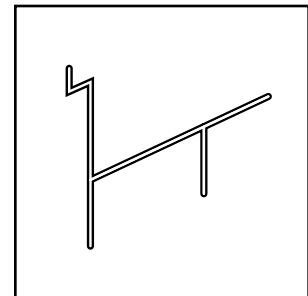

Gutter

## Tool

- #2 square head screw driver
- Measuring tape
- Level to check foundation
- 3/16" concrete bit (concrete foundation)
- 9/64" aluminum bit
- 15/64" aluminum bit fastening perlin to trusses (larger greenhouses)
- 7/16" wrench
- Razor blade cutter
- Caulking gun
- Ladder
- Hammer

## Optional

- Automatic Opener
- Circulating Fan
- Max/Min Thermometer
- Benches
- Eyebolts
- Motorized Intake Shutter
- Exhaust Fan
- Thermostat
- Heater



# *Pressure Treated Wood*

## *WHAT IS NEW ABOUT PRESSURE TREATED WOOD?*

As of January 2005, the chemicals used in pressure treated wood have been changed. Previous wood was treated with arsenic. However due to the potential long term health hazards this has been discontinued. New pressure treated wood is treated with copper.

*The copper in the 'new' wood will be CORROSIVE TO ALUMINUM as well as other metals.*

What are 'Greenhouse Friendly' solutions to the new pressure treated wood?

- 1 If you are using the new pressure treated wood, you must place a barrier between the wood and your aluminum frame. Popular barriers include 10 mil thick plastic sheeting, steel weather flashing, a rubber or foam weather membrane, or a row of weather resistant non-treated wood such as cedar or hemlock.
- 2 Other weather resistant non-treated woods are popular alternatives to pressure treated wood. These contain no harmful chemicals and will outlast pressure treated wood. Cedar timbers are a popular choice for greenhouse foundations.
- 3 Concrete foundations have always been suitable foundation alternatives for greenhouses. They can vary from poured concrete slabs, poured concrete perimeter walls to concrete block walls. Although these are usually more costly than wood alternatives, they have the benefit of lasting a lifetime. As they are usually considered a permanent foundation, it is important to check with your building codes to determine what you are able to build.

If you have any questions about using the 'New' pressure treated wood in conjunction with our aluminum greenhouses, please contact our office at 1-888-391-4433.

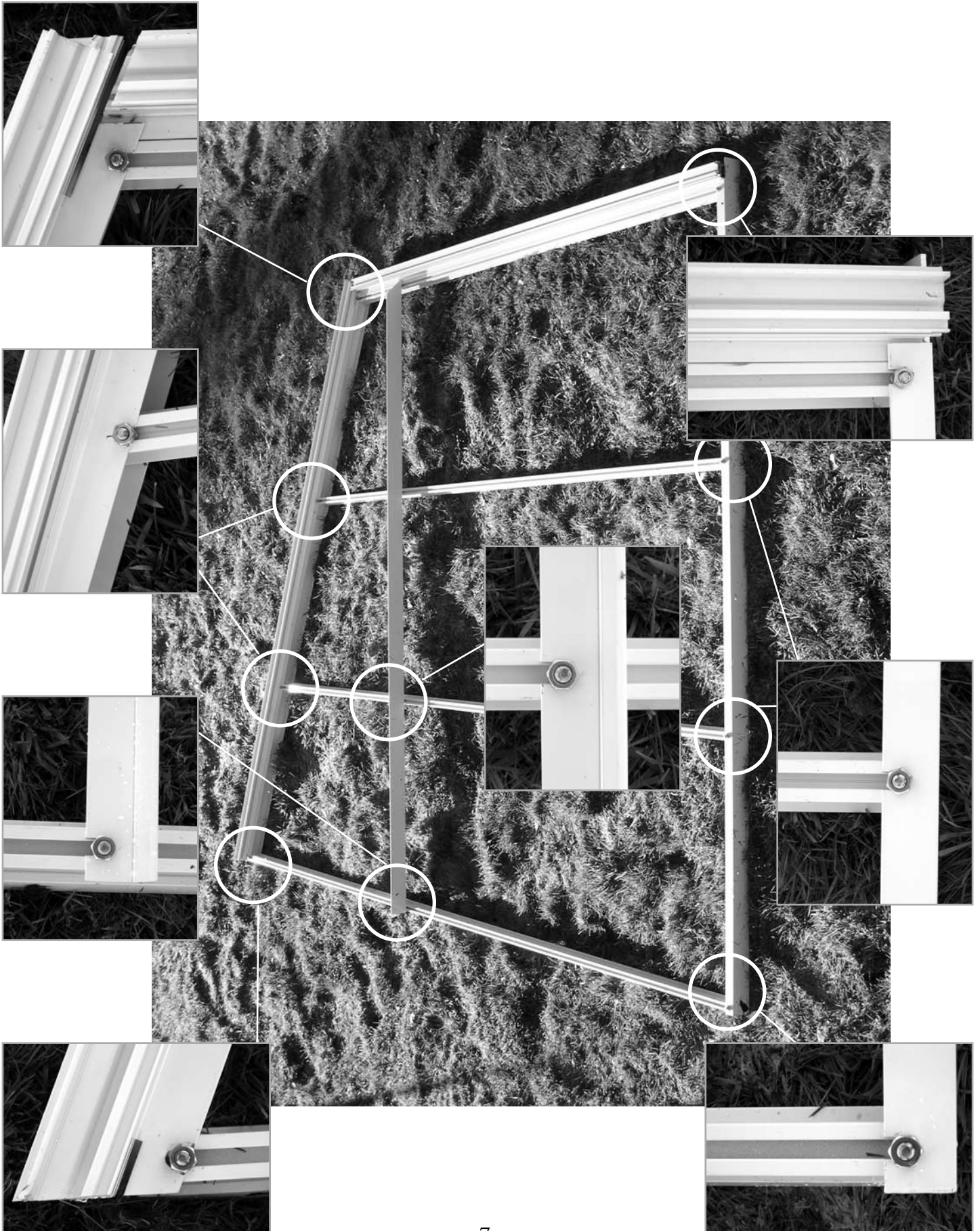



### *Back Gable End Line Drawing Assembly Procedure*

**1**

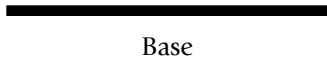

**2**

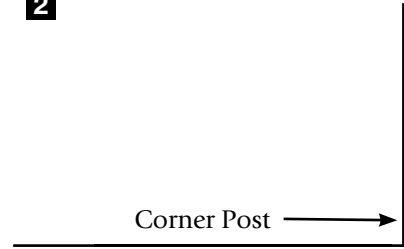

**3**

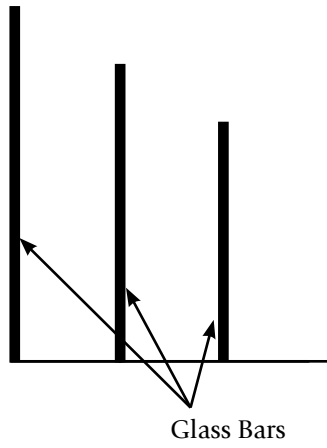

**4**

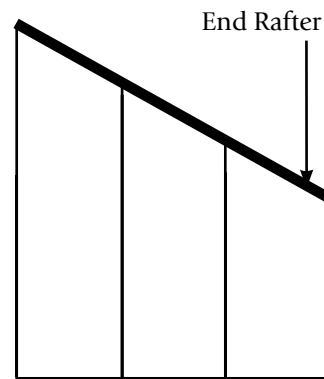

**5**

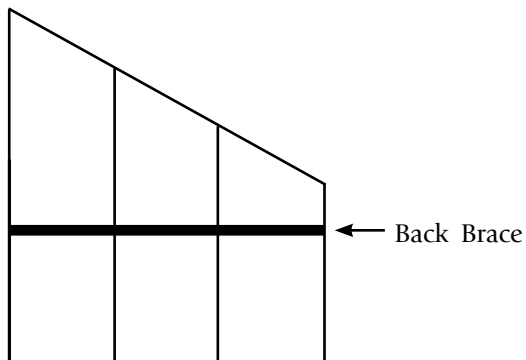

# Back Gable End Assembly

Lay out the back pieces into the shape of the end wall. See page 6 for details and refer to the line drawing on page 7.

1. The 1" x 2" angle / base laying on the ground should have the 1" side (with the slot punches out) facing up. (See Pic **A** and Sketch 1, page 8)
2. Bolt the corner post onto the base angle. (See Pic **B** and Sketch 2, page 8)
3. Bolt on all the end bars to the base. Make sure that the longest bar is at the end of the back wall. (Sketch 3, page 8)
4. End Rafter. When fastening end rafters to the cornerpost (See Pic **C**) and the long end Glass Bar, leave a 1/8" space for gutters and ridge (See Pic **D** and Sketch 4, page 8).
5. The angle horizontal brace is approx. 60" from the base bolted on with 1/4" x 1/2" bolts. (See Pic **E** and Sketch 5, page 8)

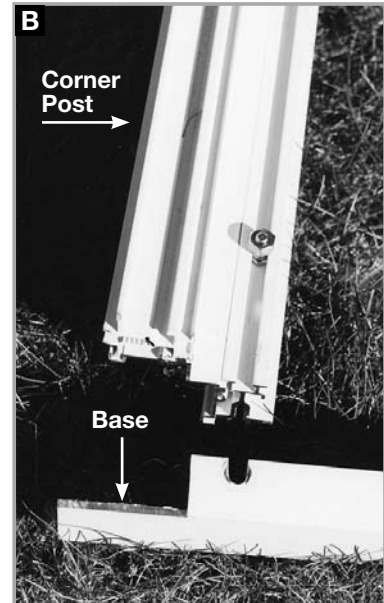

*Front Gable End (with door) Line Drawing Assembly Procedure*

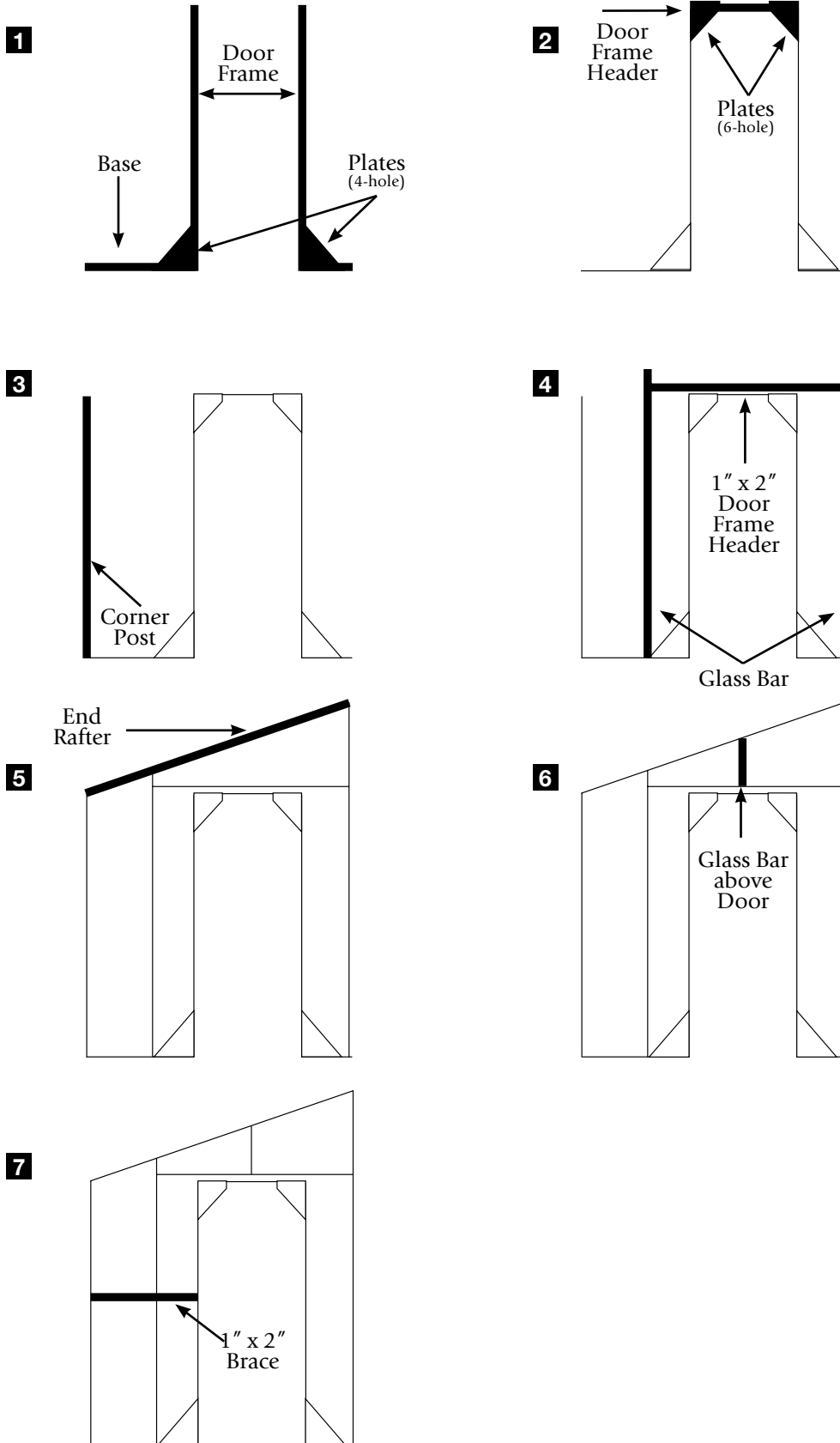

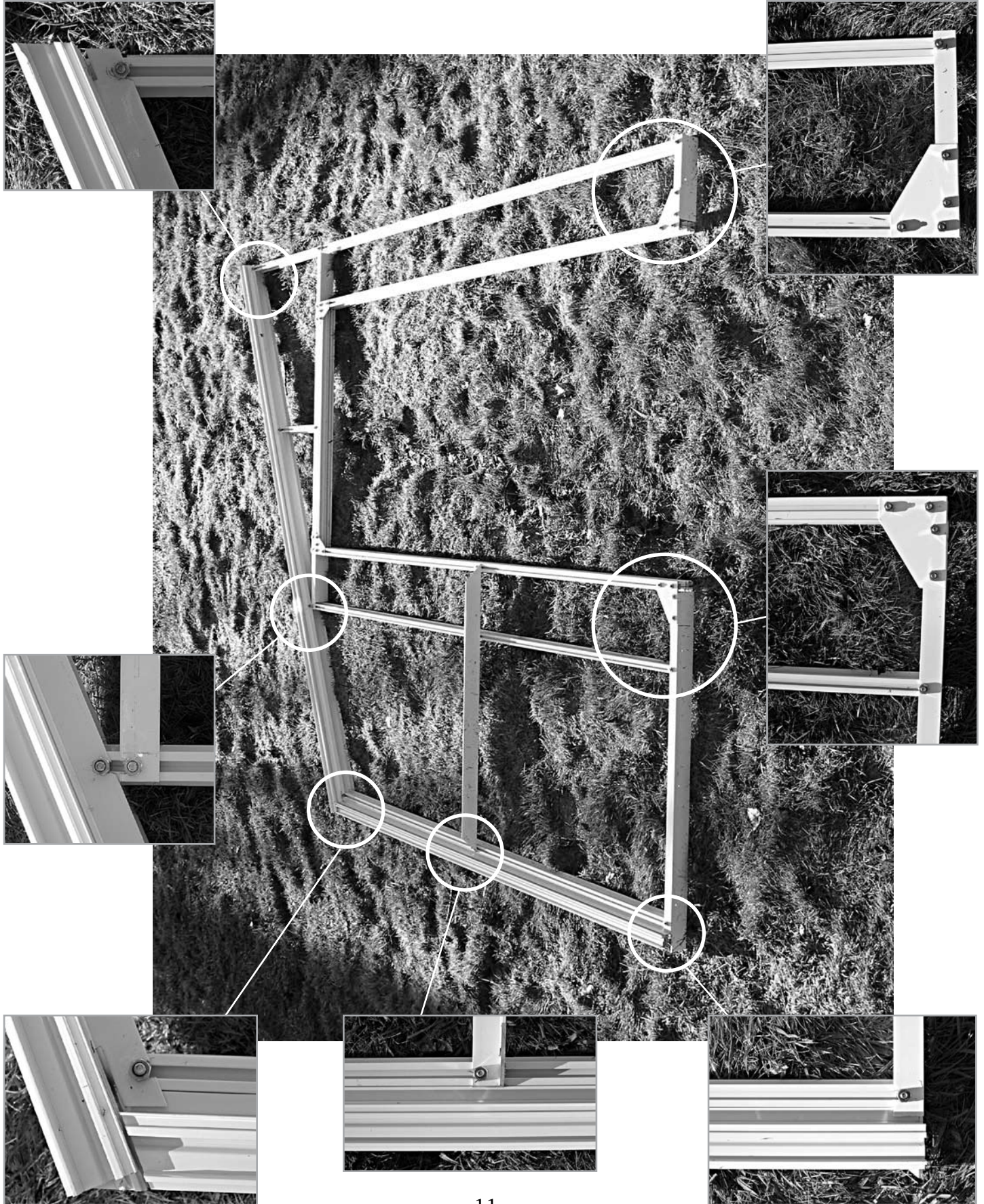

# Front Gable End Assembly

Lay out the front pieces into the shape of an end wall. The doorframe and all Glass Bars have a track for the bolts. The track must face up towards you when you assemble the gable ends. Slide the bolts in to the ends or use the notches that are punched out in the Glass Bars. Refer to the line/detail drawings when assembling. *(the sketches/drawings/pictures are viewed from inside the greenhouse).*

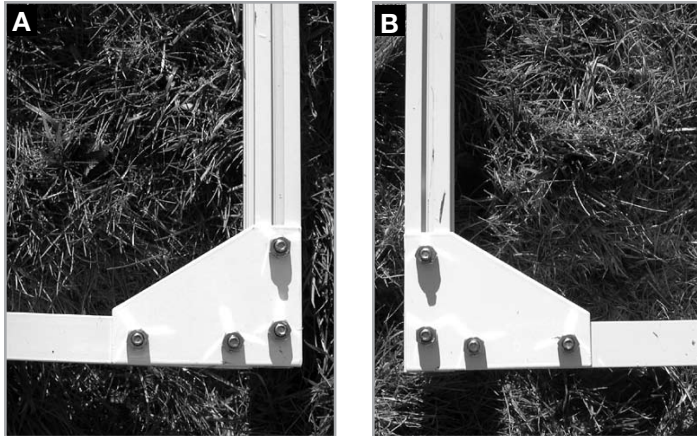

Door drop detail

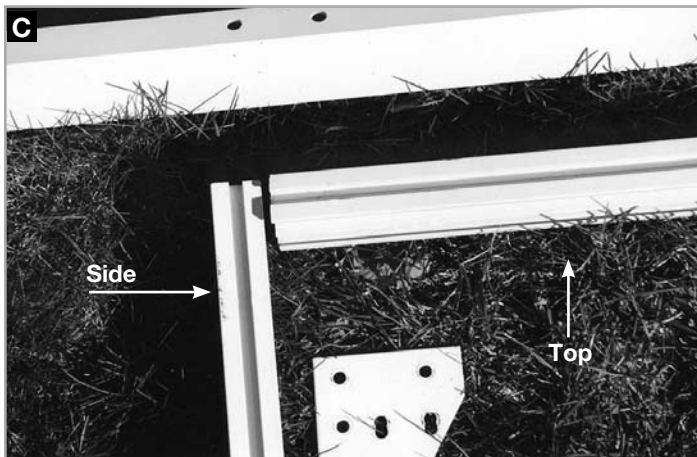
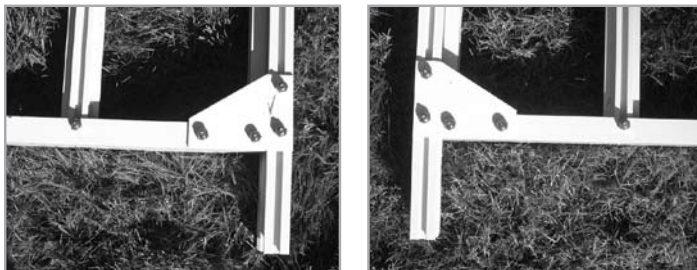

- Bolt the bottom plates (4 holes) to the base/sill and the doorframe sides using 1/4" x 1/2" stainless steel bolts (see Picture **A**, **B** and Sketch 1, page 10). Before tightening the bolts, be sure that it is square. *(If you ordered a greenhouse with a door drop, measure from the bottom of the doorframe to the underside of the base according to the specified distance.)*
- At the top of the doorframe, put on the doorframe header (which looks the same as the side pieces). Put the header *between* the two side pieces and bolt on the plates (6 holes) (See Picture **C** and Sketch 2, page 10). The plates should stick up 1" above the doorframe. Note how the plates are put on. Before tightening the bolts, be sure to square up the doorframe.
- Take the corner post (angle cut on top) and bolt it to the base (See Pictures 12 and Sketch 3, page 9).

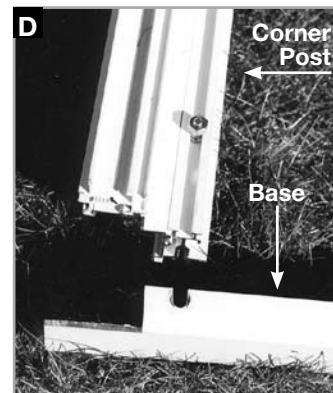

# Front Gable End Assembly (contd.)

- Take the Glass Bars next to the door frame - (see Sketch 4 on Page 9) and bolt them to the base/sill. The angle cut should match the roof slope (See Picture **E**).

The 1" x 2" angle above the door (49<sup>3</sup>/<sub>4</sub>" long) can now be bolted on. The 1/4" round holes should be lined up with the holes in the plates (See Picture **F**). Each end of the 1" x 2" angle has a slot punched out to accommodate the bolt that is lined up with the Glass Bars 24 1/2" from the center.

Slide a bolt in the top of the Glass Bar and fasten the angle to it (See Picture **G**).

- Bolt the 1" x 2" horizontal brace at approximately 3' from sill/base. On larger greenhouses, a diagonal 1" x 2" is sometimes used.

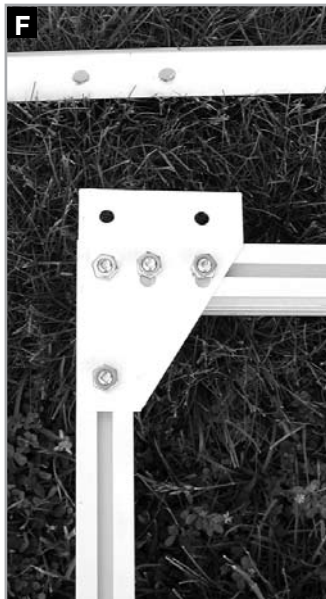

# Door Frame Assembly

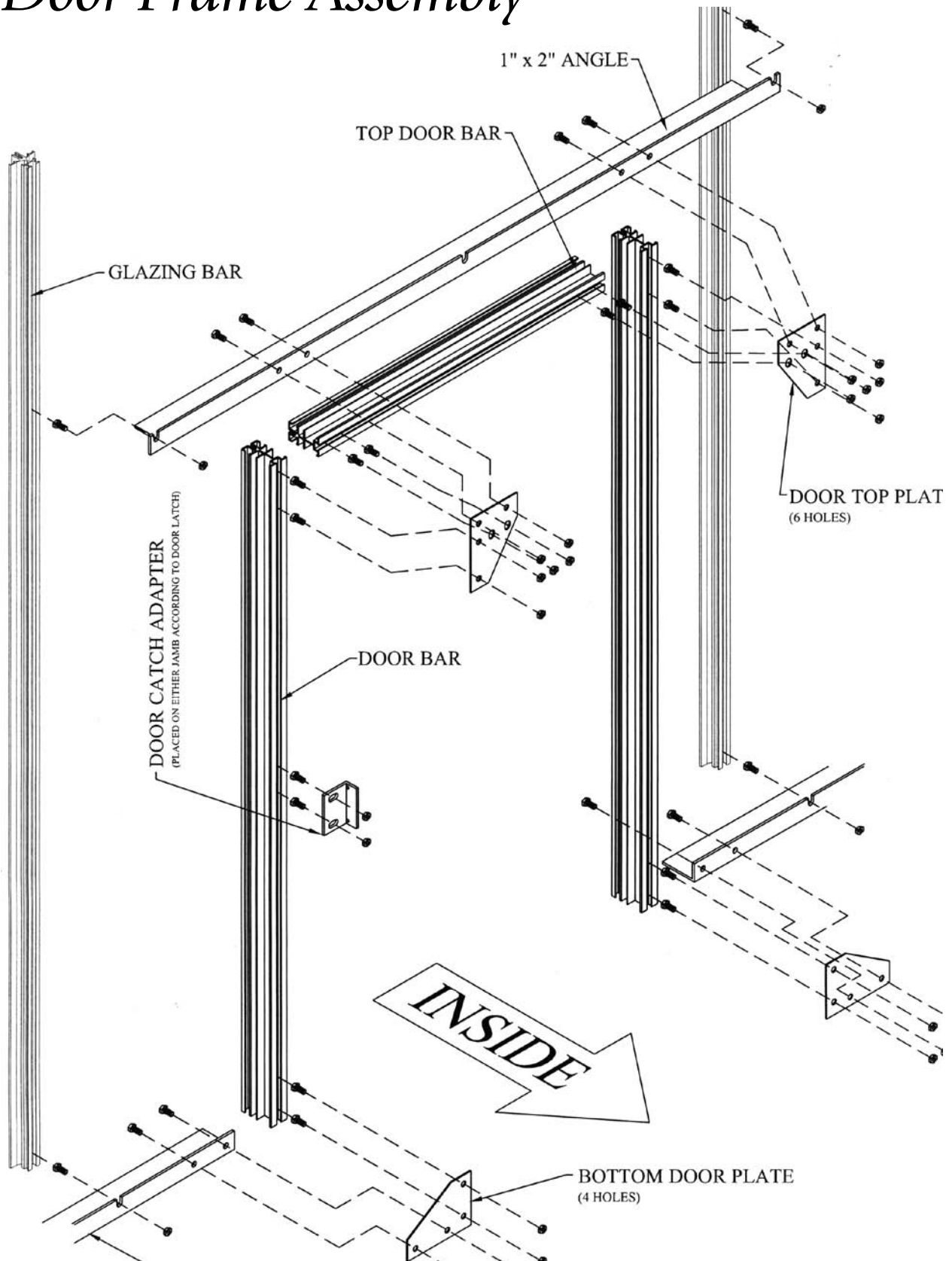

# Front Gable End Assembly (contd.)

- End Rafter - when fastening end rafters to the corner post, and long Glass Bar, leave a 1/8" space for the gutter and ridge to slide through (Picture **H** and Sketch 5, Page 10). The punch marks in the end rafter will line up with end Glass Bars. Slide the bolts in the top of the Glass Bar before you put on the end rafter.



- At this point, you can install all the end Glass Bars. (A smaller greenhouse will only have 1-bar above the door) (See Picture **I** and Sketch 6, page 10).



- Smaller sized greenhouses have a horizontal brace (See Picture **J** and Sketch 7, Page 10). Larger sized greenhouses will have a diagonal brace from the top door frame plate to base/sill 2" from the corner post.

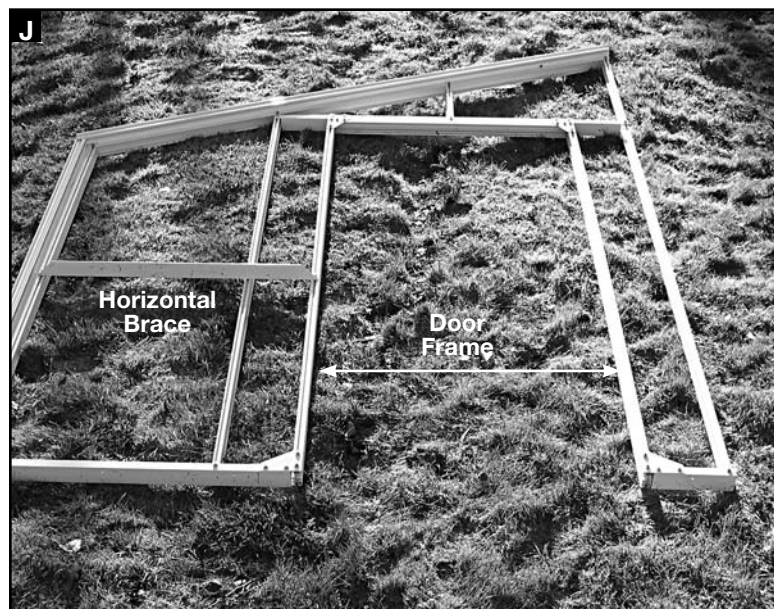



# Sidewall Assembly

Lay out the sidewall with the gutter at the top - base at the bottom *See Picture **A***. You will notice that each sidewall Glass Bar has a straight and an angle cut. The straight end fits against the base (*See Picture **B***) and the angle goes towards the gutter (*See Picture **C***). Always face the bolt slot in the Glass Bar towards you.

1. Take all the Glass Bars and bolt them to the gutter (*See Picture **D***). Start your bars approximately 2' in from the end of the gutter and base (*See Picture **E***) (*Corner post will be fastened to the ends when the greenhouse is assembled.*)
2. Bolt the Glass Bars to the base.

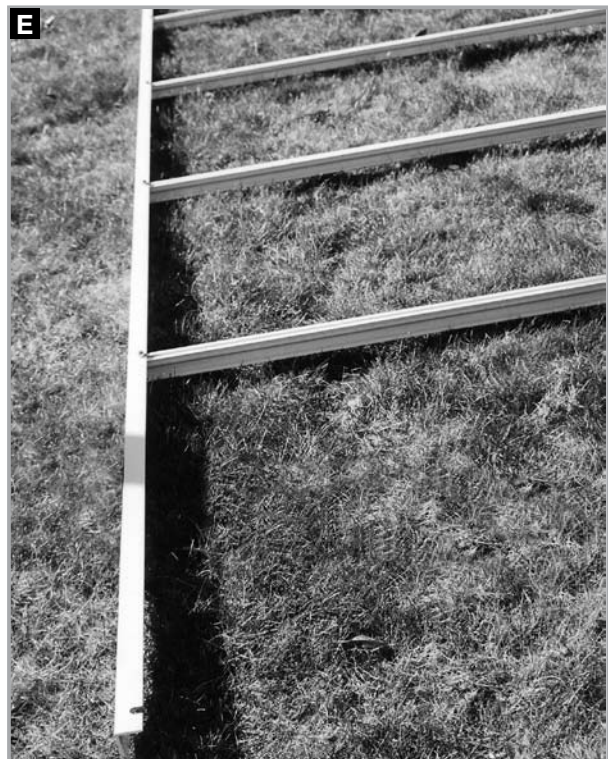
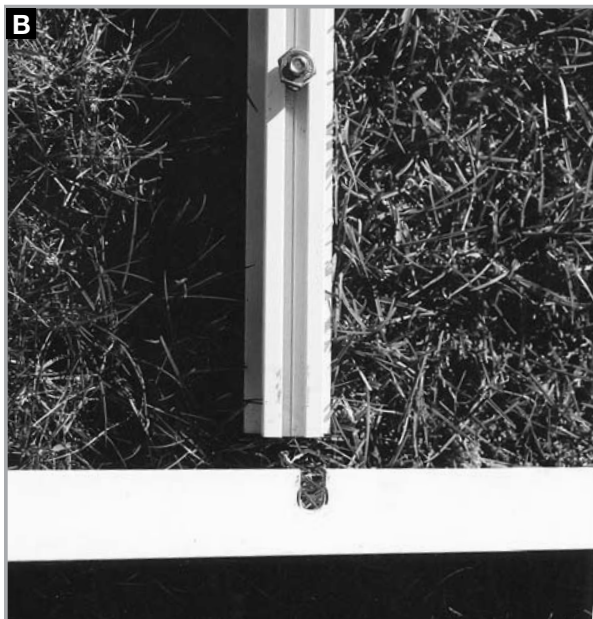
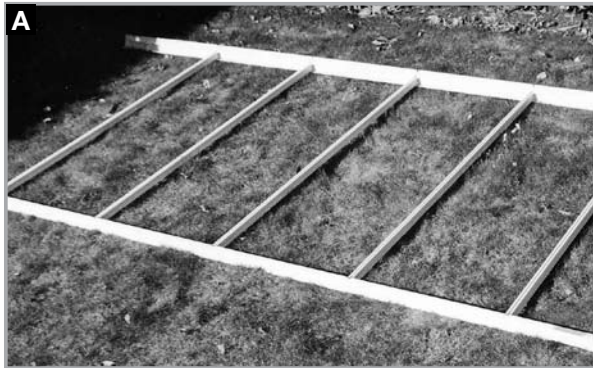

# Aluminum Frame Assembly & Installation

## 1. BACK GABLE END (See Page 19)

Take the assembled back gable end and stand it up on your foundation. (Slide a bolt into the top of the corner post, move it down approximately 3" and temporarily tighten the bolt).

## 2. SIDE WALL (See Page 19)

Stand up side wall. Slide the gutter (sidewall) in between the end rafter and the corner post. (There should be a 1/8" space – see Picture **A**). By sliding the gutter in as far as it goes, the punched out slots line up with the bolt track in the back of the Glass Bar (See Picture **B**). Undo the bolt in the corner and slide it up into the slot and tighten up. Fasten the bottom base (See Picture **C**). Make sure the side base fits in between the corner and end base.

## 3. FRONT GABLE END (See Page 19)

Follow the same procedure as the back gable end.



# Aluminum Frame Assembly & Installation (contd.)

## 4. RIDGE (See Page 20)

**NOTE:** Refer to drawings for ridge height. Before you slide in the ridge, put one bolt in the top of each end bar. Take the ridge (one person at each end) and slide it between the end rafter on the top. You will notice the punched-out slots in the bottom flange of the ridge. The end slot lines up with the bottom side of the end rafter Glass Bar. Now slide in the ridge and slide the bolt up into the ridge slot. Make sure that the Glass Bar is tight against the ridge – use a 7/16 flat wrench (at this time you can temporarily fasten the ridge to keep it from moving round) (See Picture **E**).



## 5. GLASS BAR WITH VENT SLIDERS (See Page 21)

Each Glass Bar has a small vent frame slider on it. They are marked 1/2/3/4 etc. On the ridge there will be the same markings. Slide a bolt in the top of the Glass Bar. Put into place with the angle cut on top (Note that the numbers are the same). Line it up with the punched out slot in the Ridge. Slide up the bolt and fasten it. (See Picture **F**).



## 6. VENT FRAME BOTTOM SECTION (See Page 22)

The vent frame bottom fits in between the Glass Bars that you have just installed (See Picture **G**). The 2" side of the angle faces towards the Ridge. Move the bolt up the Glass Bar and fasten it.



## 7. REMAINING GLASS BARS (See Page 22)

All remaining Glass Bars can now be installed. Make sure that the top is against the ridge. Before you tighten the Glass Bar on the gutter, eyeball the gutter to see if it is straight. There is usually about a 1/8" space between the Glass Bar and the gutter.

## 8. ROOF PURLIN (CHANNEL) *(See Page 24)*

When installing the roof purlin, mark it out by measuring from the ridge. The roof purlin should be located approximately the center between the ridge and the gutter. Always face the open end of the purlin up towards the ridge so that it can be used for hanging baskets. Every Glass Bar has notches punched out so that the head of the bolts can be inserted and can slide up or down on the bar.

## 9. TAPE ALL GLASS BARS *(See Page 25)*

Complete all taping with the 1/8" foam tape - *install side vent frame sliders before taping the bars (if it was not done before)*.

Do not put foam strips in between the glass and the base, and beside the door frame.

## 10. FASTENING / SEALING THE GREENHOUSE TO THE WALL

Before you seal behind the ridge and end Glass Bars, square your greenhouse using the 3/4/5 method *(see sketch)*. Sometimes the foundation is level but your wall is not plumb. You may have to decide to pull the greenhouse away from the wall or make your foundation off-level. When your greenhouse is squared up, mark the edge of the ridge on your wall and pull your greenhouse away from the wall and seal behind it. Push the greenhouse back to the wall and fasten it with screws.  
**NOTE:** *Sealing can also be done after greenhouse is finished and before the vents are installed.*

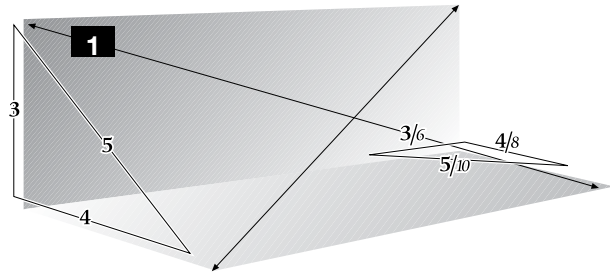

## 11. SIDE VENTS, INTAKE SHUTTER AND EXHAUST FANS INSTALLATION (IF NECESSARY) SEE APPENDIXES B THRU E. THEN RETURN TO THE NEXT PAGE AND CONTINUE

**Note:** *Make sure the greenhouse is fastened to the foundation with 1" screws.*

## OPTIONALS

**SIDE VENTS, INTAKE SHUTTERS AND EXHAUST FAN INSTALLATION:** See Appendix B-E *(Pages 39 – 41)*.

**TRUSS:** If the greenhouse is larger than the instructions show, it will require a truss. Insert a truss after the Ridge *(See #4 Page 17)*. Follow up with installation of the Perlin *(See #8, this page)*. Truss assembly sketch is on Page 38.

# Assembly Outline

Step 1:  
Back Gable End



Step 2: Side Wall

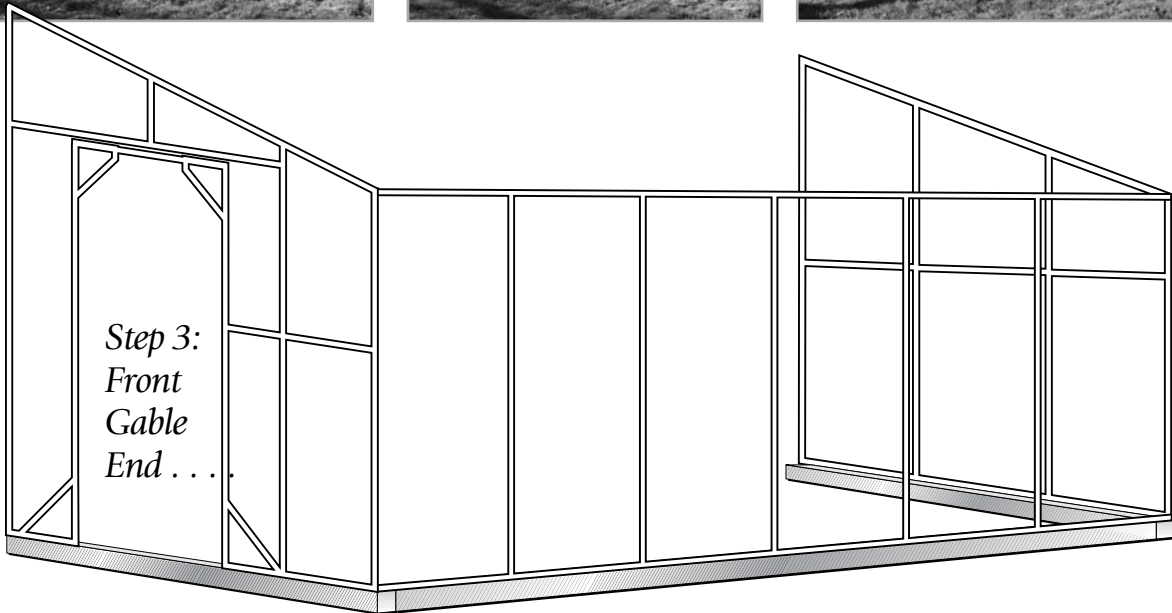
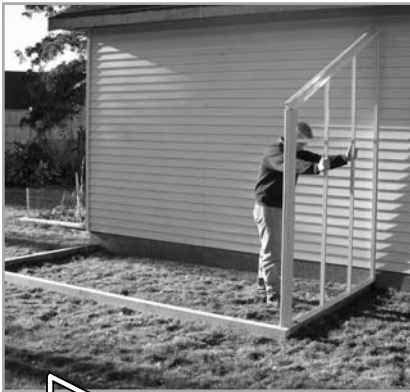
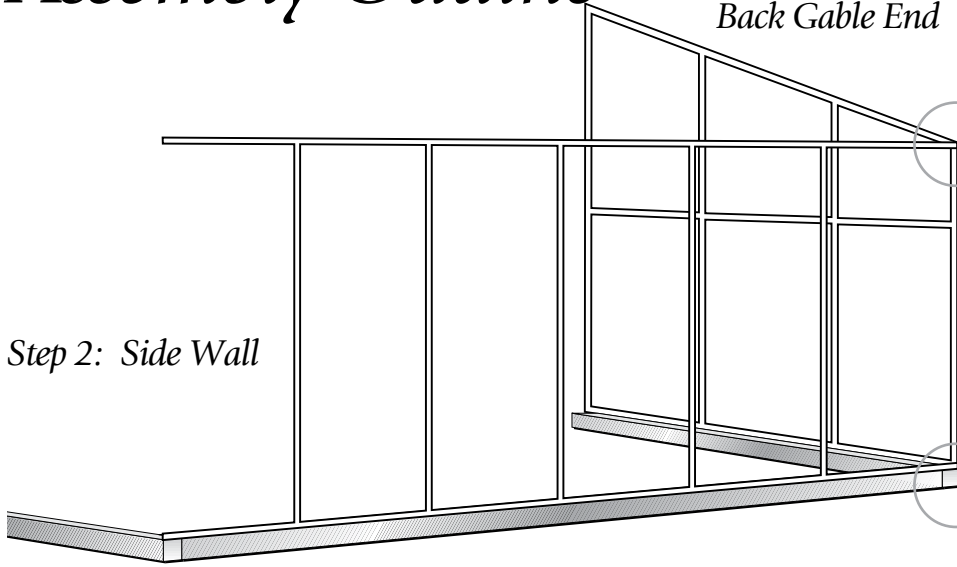

Step 3:  
Front  
Gable  
End . . . .

*Step 4: Ridge*



*Outside view*

*Inside view*



*Outside view*



*Inside view*

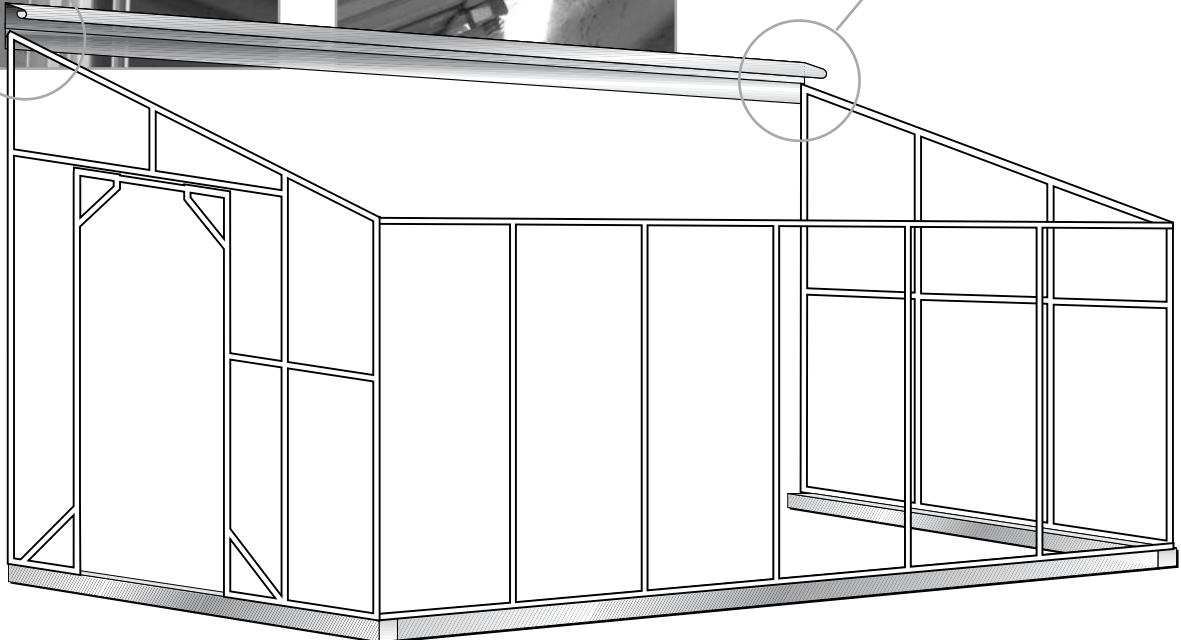

*Step 5: Glass Bar with Vent Frame Sliders*

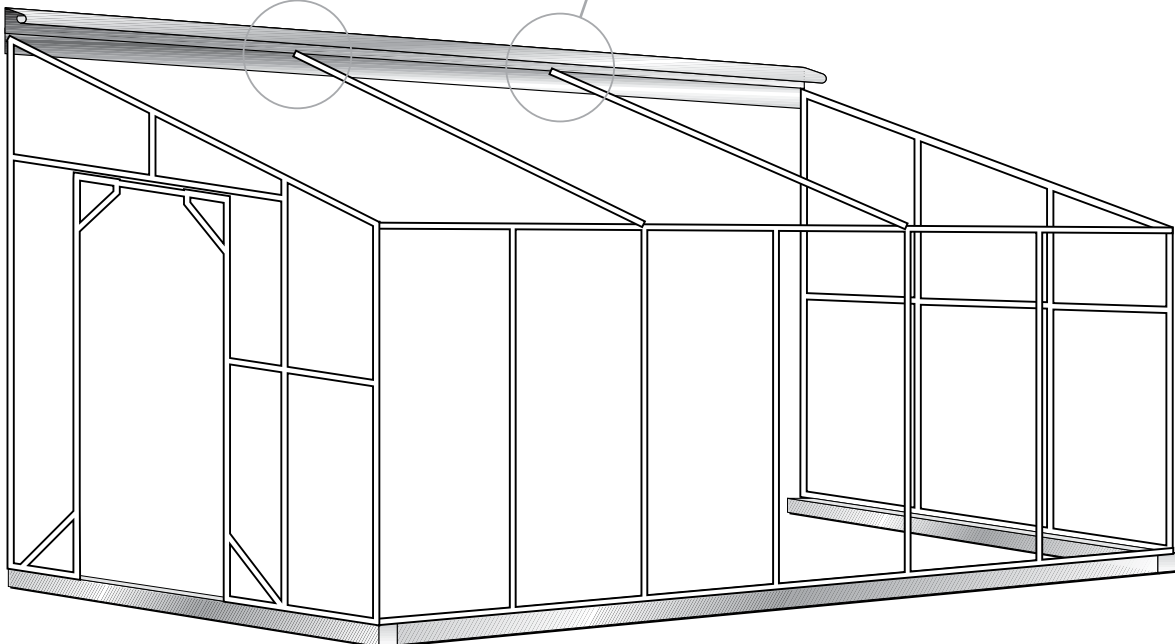
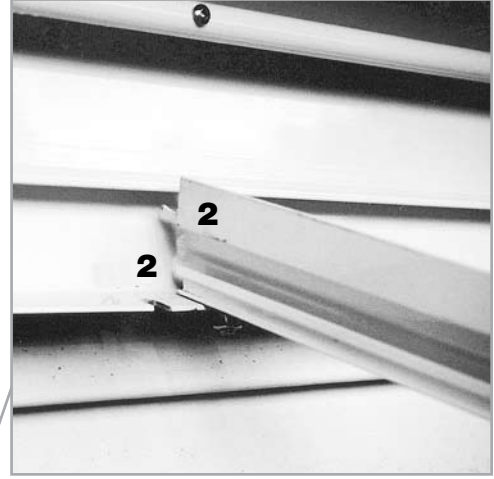

*Step 6: Vent Frame Bottom*

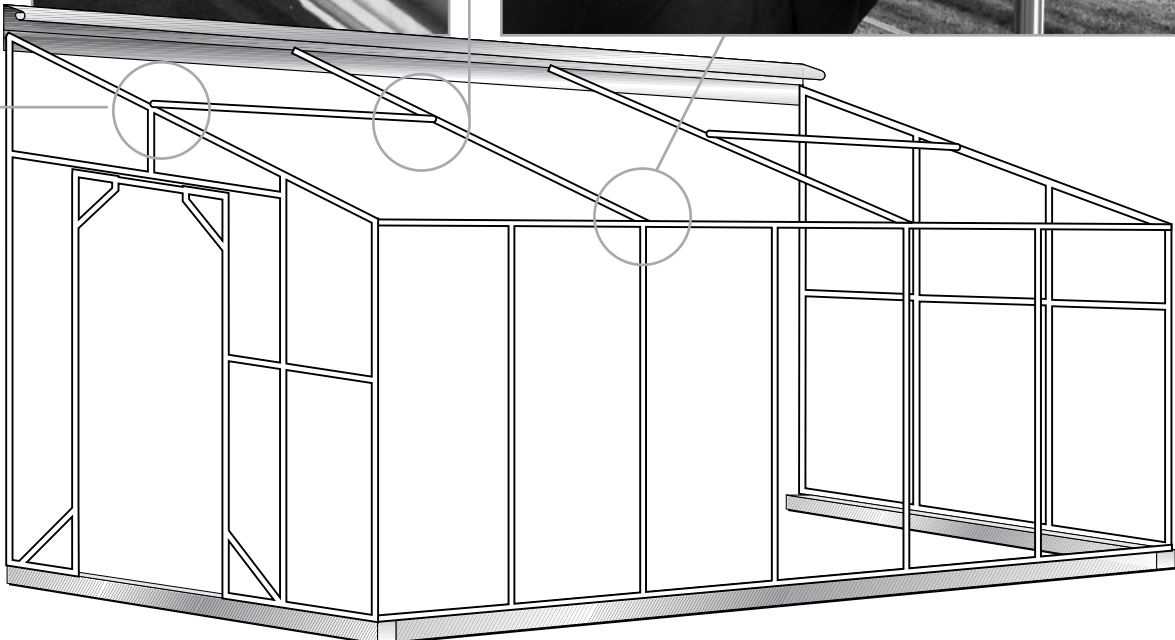



*Step 7: Install All Remaining Glass Bars*

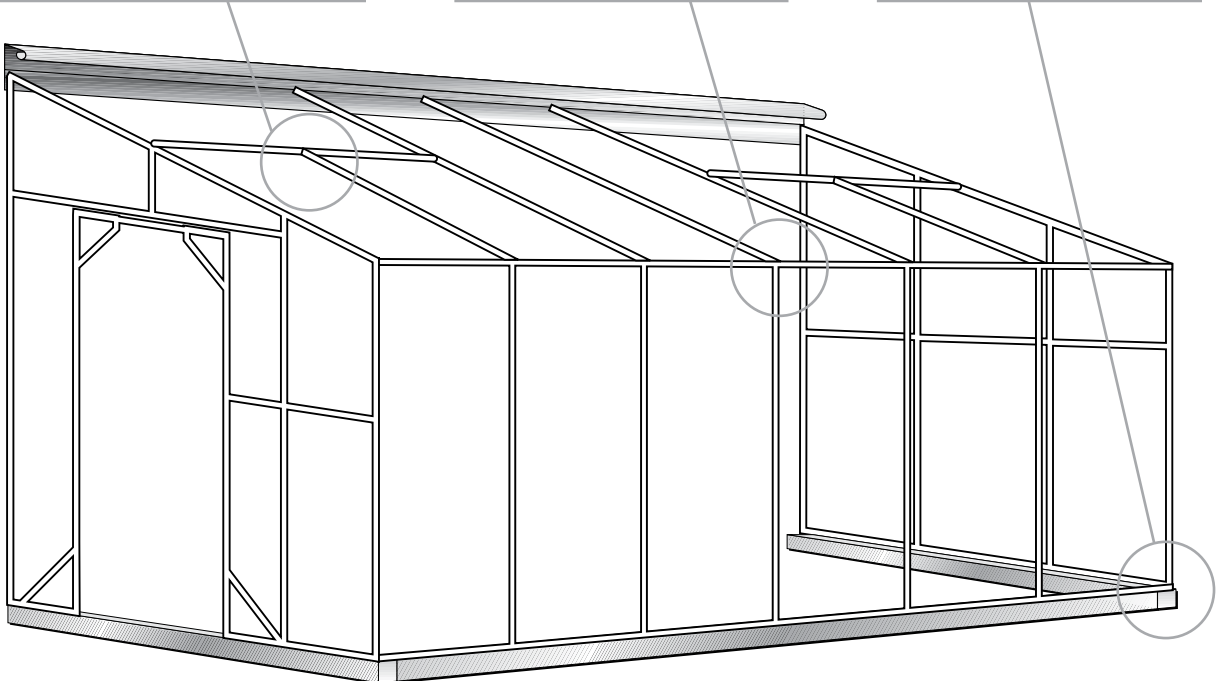

*Step 8: Roof Purlin*

*1 1/2 x 3" x 3/16" Purlin  
on Larger Greenhouses*

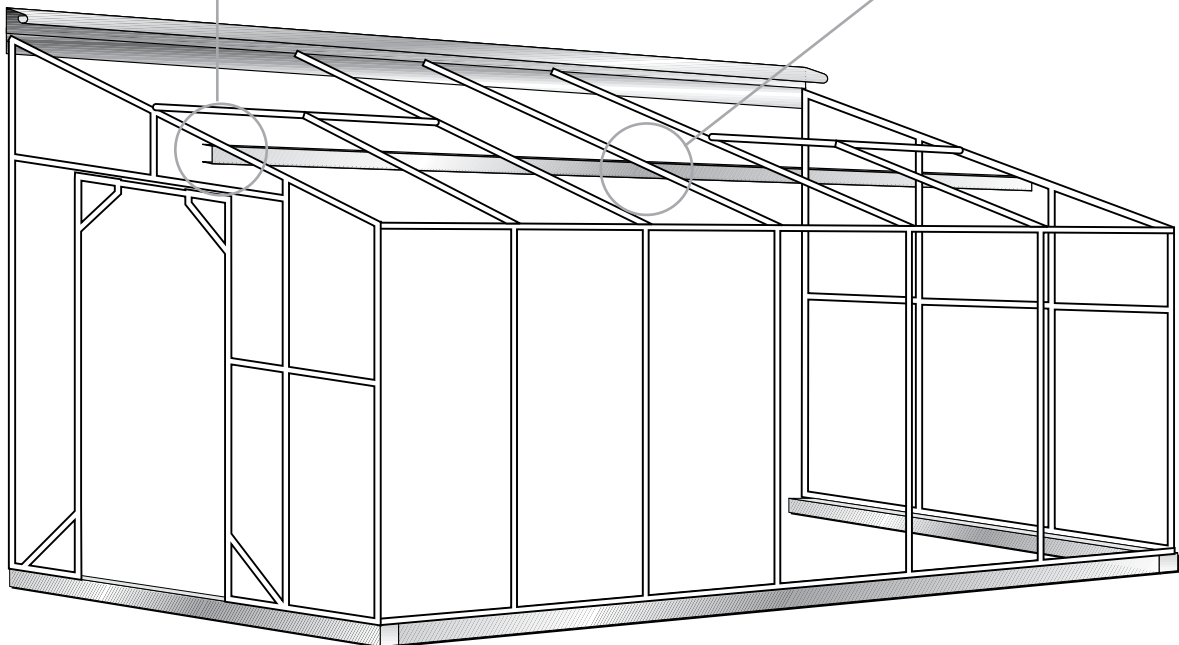
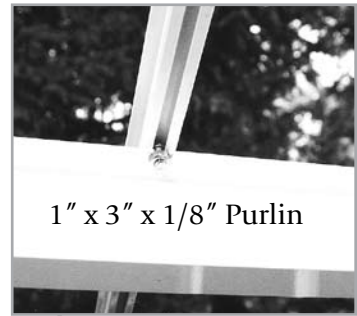

## TAPING GLASS BARS WITH FOAM

Tape all the aluminum Glass Bars with 1/8" foam tape both sides. Take a roll of tape and start at one end and press on the bar. *Make sure that the aluminum is dry.* Slowly roll down the tape toward the outer edge and press it down at the same time (See Pictures). Be careful because sometimes the edge of the paper is quite sharp. Do not remove the paper until later.

### NOTE:

*Taping the greenhouse can be done before you put the frame together.*

*If the weather is bad or dark outside, you bring everything inside the garage and put the foam strips on the bars.*

*Make sure that the front / glass / side / roof bars don't get mixed up, it would make it much harder to put it together.*

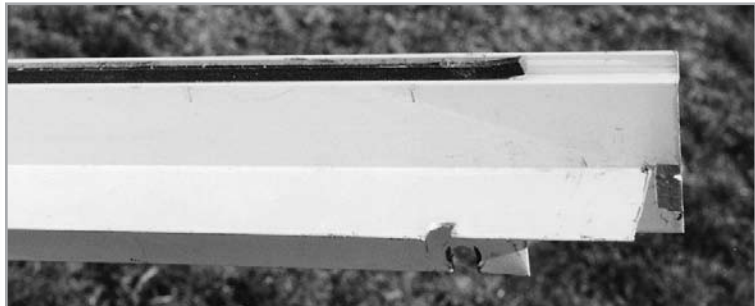
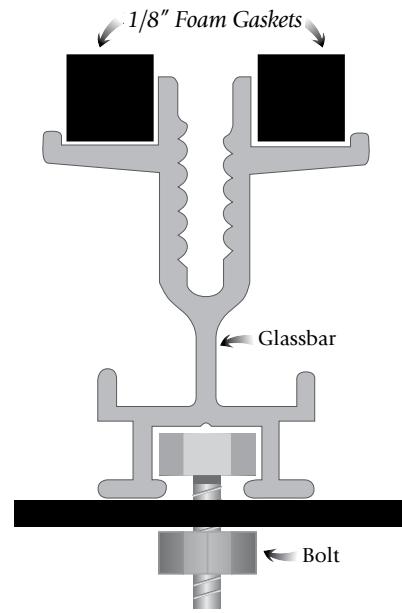
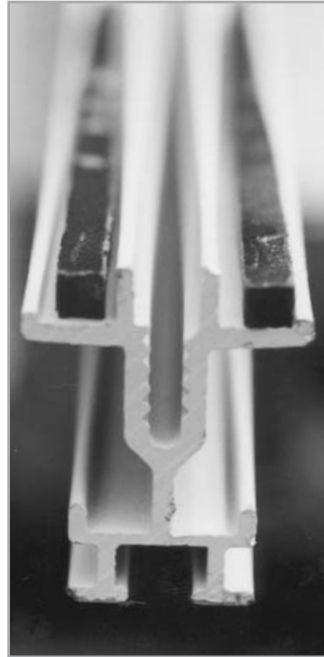

*Foam tape the lip of the gutter as shown*



# Glass & Cap Installation

## GENERAL INFORMATION

*Important points to consider:*

- Square up (or adjust) the frame to fit the glass. If the foundation is square and level, the greenhouse will automatically be square when all the glass is in. Don't try to square up the whole greenhouse before you do the glass. Just do one side at a time.
- Always work one row across at a time.
- Don't over tighten screws (*"finger tight" plus a quarter turn is sufficient*).
- Position glass in between the inside edges of the bars.

Glass comes packaged in cardboard cases. When storing glass, put it upright against a wall or post. All glass is a 3mm / 24 oz. thickness (*unless it is a special order*). When handling glass, put one hand on the bottom and one hand on the side. Do not hold the glass flat on your hands.

**WHEN LAYING OUT THE GLASS FOR YOUR GREENHOUSE, DO NOT LAY THE GLASS ON YOUR LAWN WHILE THE SUN IS SHINING BECAUSE THE GLASS WILL BURN THE GRASS.**

## GLAZING

Remove all paper from the foam strips. **1**

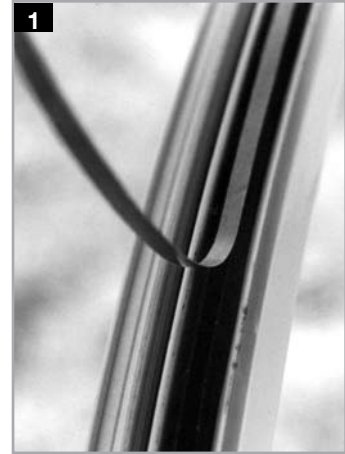

## SIDEWALLS (*see the glass sketch for sizes*)

- A. Take a piece of glass and hold it along the long side. Set the 24" width of the glass on your aluminum base against the Glass Bar and push it gently toward the greenhouse **2**. If the

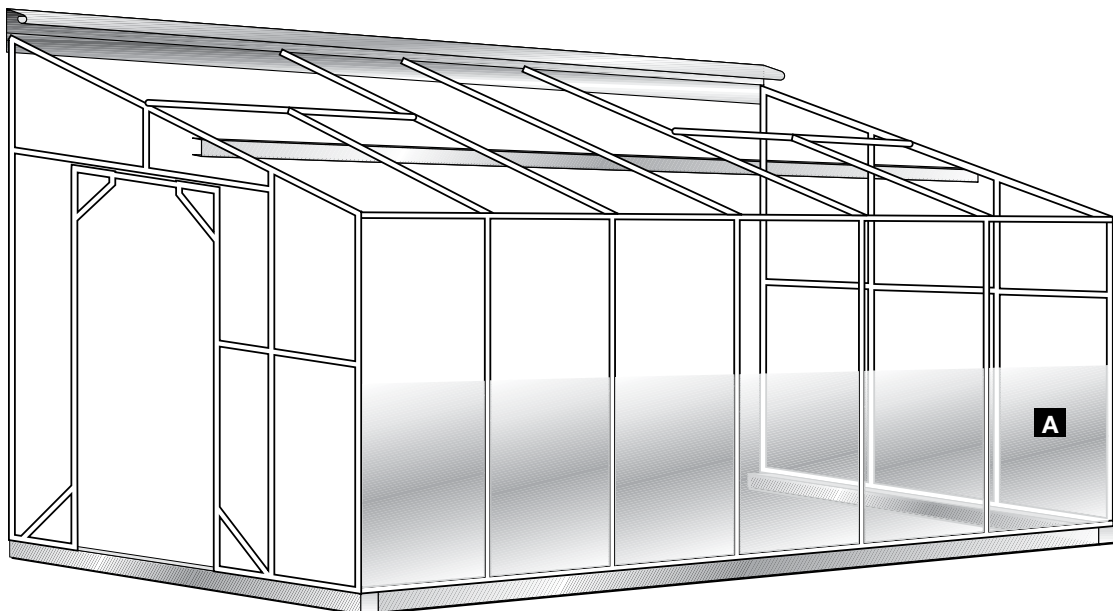

## Glass & Cap Installation (contd.)

greenhouse is not square, push the Side Wall over to square it. If it is a warm day, the foam will stick to the glass and you can walk away and get your aluminum cap. The cap (*see glass sketch for length*) is pushed against the glass **3** (*It is a 1/2" shorter than the glass where there is overlaps 4*). Use #8 x 3/4" screws to fasten the cap to the Glass Bar. Hold the cap against the glass and put in your screws. When the screw hits the cap, make a 1/4" turn. In other words, *do not tighten the screws too tightly*. Also, do not put a screw in the top hole of the cap. When the first piece of glass and cap is installed, go to the next bay. Finish off the bottom row on one side only.

- B. Install the next row of glass, push the glass underneath the gutter and set it on top of the bottom cap **4**. Take the aluminum cap (*for length, see sketch*). The bottom hole of the second row of caps line up with the top hole of the first row of caps. Again, do not tighten the screw too tight. On a standard greenhouse, this row will finish off the sidewall below the gutter.

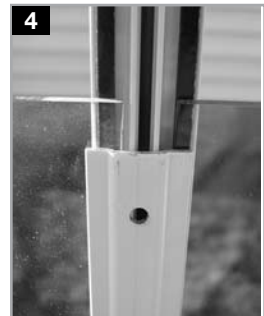

# Installing the Roof Glass

## INSTALLATION

- Install the glass by setting it in the horizontal gutter piece and letting it down slowly to the foam strip. If everything is square, level and plumb (*straight*), the glass should fit. If the glass does not fit - move the Ridge to either the right or left until a fit is obtained.
- Install glass on the bottom row in the roof first.
- Attach and fasten the Caps (*caps are 1/2" shorter than the glass*).
- Put in the second row of Roof Glass overlapping the first 1/2". Settle the glass against the cap. (See Picture **A**).
- The second row of caps are 1" longer than the glass. When you put them on, the first hole in the cap lines up with the last hole in the previous cap.
- Before you lay down the second row of glass, cut a 8" (*plus/minus*) piece of foam and lay it against the first piece of glass and on top of the existing foam (*it fills the space of the overlap*).
- After you have finished the second row - the third row is installed the same way.
- Last row below the Ridge - the glass slips in underneath the Ridge flange.
- When the side of the roof is done, seal the glass below the Ridge and around the vent frame with silicone.

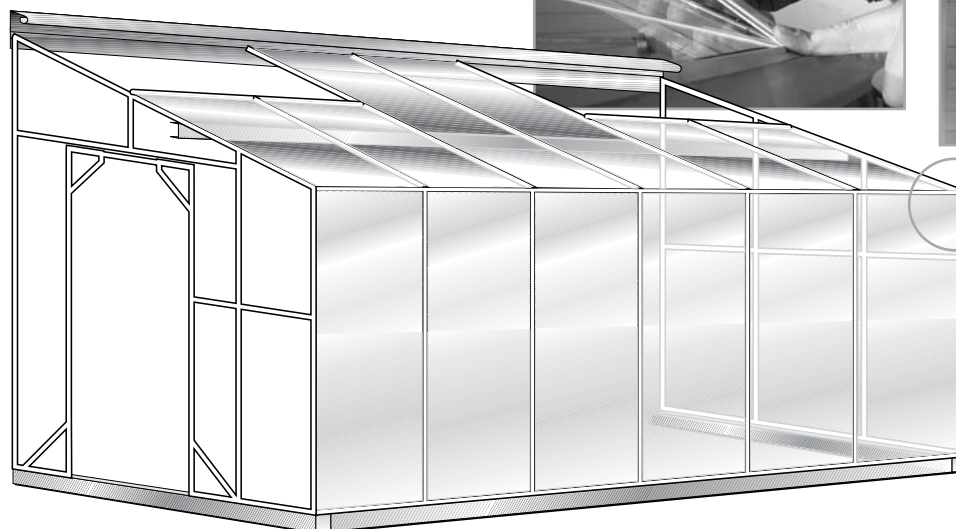
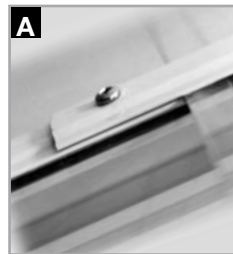

# Installing Glass in the Door End

## INSTALLATION

---

- Install the bottom row first. After setting the glass in place, attach the Glass Caps (*see sketch for length*).
- The second row and each succeeding row has the same size glass (as per sketch) but they overlap the previous row by 1/2" and are held in place by an Aluminum Cap (*see Side Glazing*).
- Do not caulk the bottom where the glass rests on the base. This allows for any condensation to seep out.
- The glass beside the door is pushed into the door frame. The second row of glass sits on a plastic "H" Came.
- Installing the Back Gable End Glass is the same as the front.

**Note:** Do not be afraid to adjust the frame to make it square with the glass.

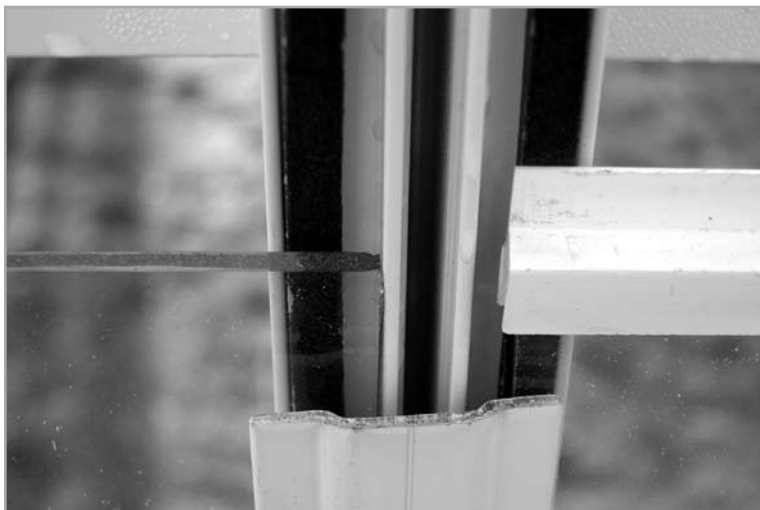

# Sealing the Greenhouse

Caulking is used for sealing aluminum to the wood / concrete base. However, for most people, silicone is easier to use when sealing aluminum to glass.

*The areas that need to be sealed with CAULKING are:*

- Top – behind the Ridge
- Base of the greenhouse to the foundation

*The areas that need to be sealed with SILICON are:*

- Below the ridge **1**
- Around the door frame **2**
- Angle above the door **3** & **4**
- Around the vent frame **5**
- Beside the door frame **6**





# Door Installation

(Refer to the drawing.) Take the door and set it inside the door frame. Lift it up as high as possible on the hinge side and put the screws through the existing holes in the door frame. Now the door will hang by itself.

Remove the black clip from the "Z" bar and put one screw into the door frame to hold the "Z" bar. Open the door, take off the clips and put back the screws. Close the door and check that it is square. If the frame and the door are square, then fasten the "Z" bar to the frame. If not, move the "Z" bar up or down to square it. If this is not enough, loosen the bolts in the top plates and move the frame to make it square. When it is in place, tighten all the bolts.

Next install the door handle (see the instructions inside the box). To install the door catch angle, slide in two bolts into the back of the door frame. Bolt on a small angle (provided with the door handle).

Face the angle towards the door, line it up with the center of the door handle, and then tighten the two bolts (see picture to the right). Take the door catch out of the door handle box and screw it on. Close the door and adjust the door sweep at the bottom of the door to eliminate potential gaps.

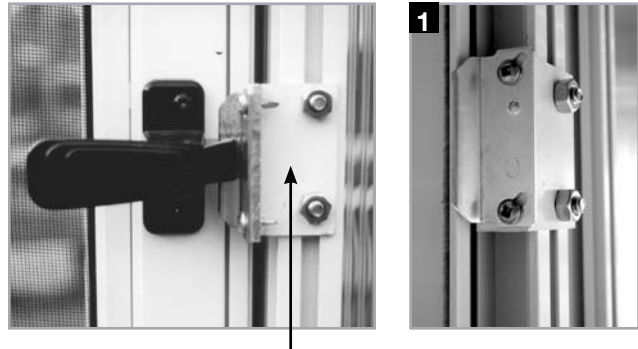

Door Catch Angle

**NOTE:** There are two types of manufactured doors. The door catch angle on the white door may have to be turned the opposite way as shown on picture **1**.

Run a bead of silicone under the angle above the door and against the door frame. Also silicone the glass beside the door to ensure an airtight seal.



# Door Installation

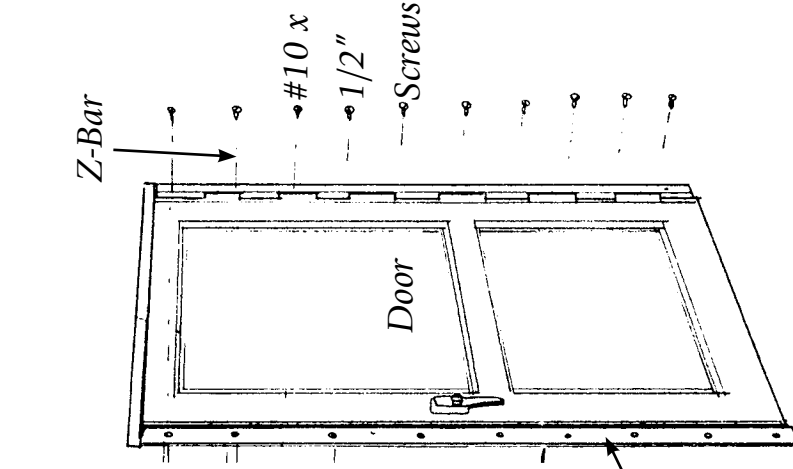
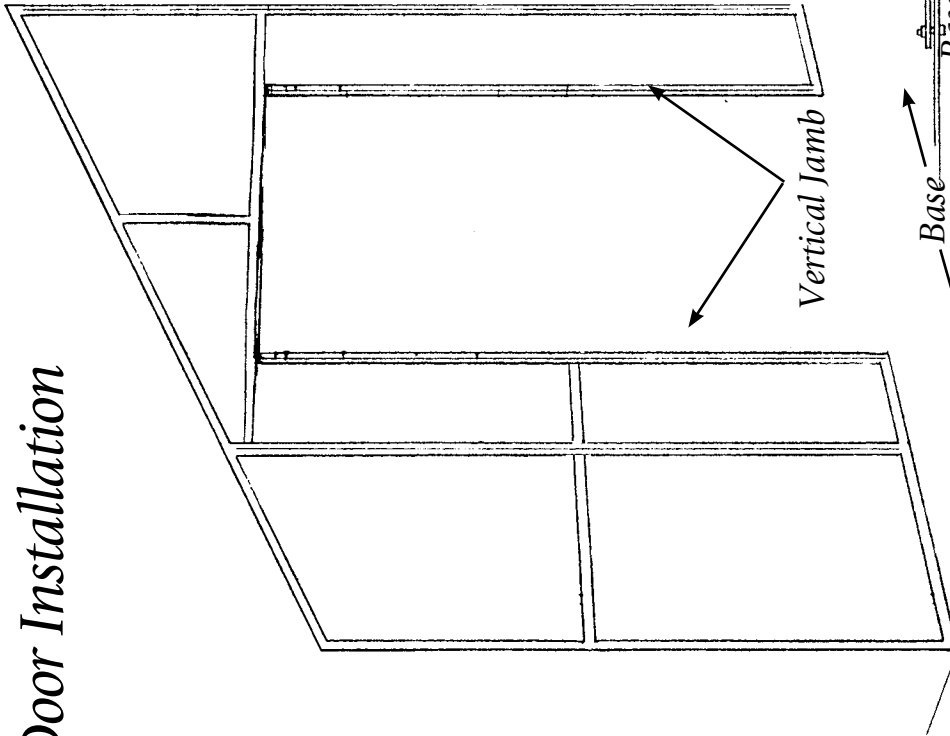

OUTSIDE GREENHOUSE

Plan View

INSIDE GREENHOUSE

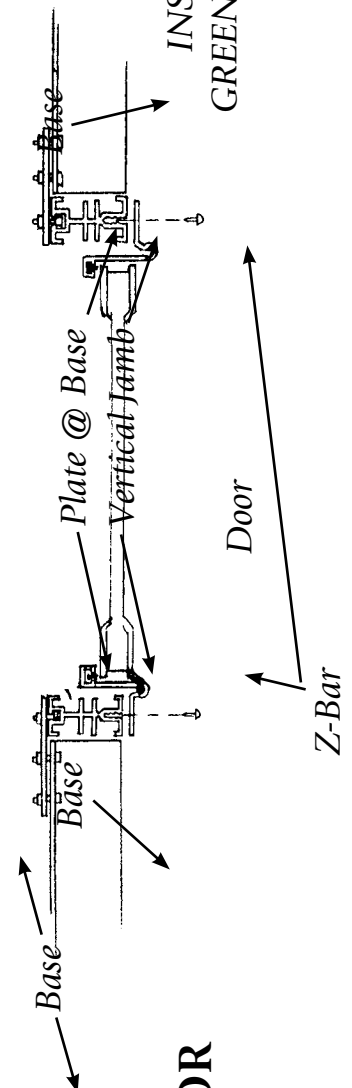

ATTACH DOOR

# Vent Assembly

(See Drawing on Page 33, pictures on Page 34)

1. Lay down the vent gutter with the punches facing up towards you.
2. Glass bars with sliders are for the end. Lay them down with the bolt slot facing up.
3. Lay the vent hinge with the punches facing up towards you.
4. Slide the bolts into both ends of the end bar (1/4" x 3/8"). Take the gutter and line up the bolt with the first punch, slide the bolt down and tighten it. Do the same with the hinge, the other side and center bar. Make sure that the Glass bars fit tightly into the gutter and hinge after the vent is assembled.
5. Turn it over and square it up.
6. Put the 1/8" foam on the Glass bars and Gutter.
7. Take the glass and slide it up into the hinge track. Drop it down on the gutter. Do the same with the next piece of glass.
8. Take the caps and lay them on the bars, center them and screw them on with a 3/4" screw.
9. Take the silicone gun and seal where the glass slides into the hinge.
10. 3/4" screw through hinge and gutter into glass bars.



## VENT INSTALLATION

Take the vent and slide it into the end of the ridge (See Picture **A**).

After you remove the screw in the ridge, push it into place and put the screw back in (See Picture **B**). Now attach the automatic opener.

# Vent Opener

## INSTALLING THE BAYLISS AUTOMATIC VENT OPENERS

Detailed instructions are included in the box with the control (there are a few extra parts).

Use #10 stainless steel screws to fasten the Bayliss and the vent sill ① and the ② vent

All holes are already drilled.

After the Bayliss is fastened in place, install the threaded adjuster into the swivel block. This is made easier by lifting the vent with one hand until the piston rod only projects 1/2" through the swivel block.

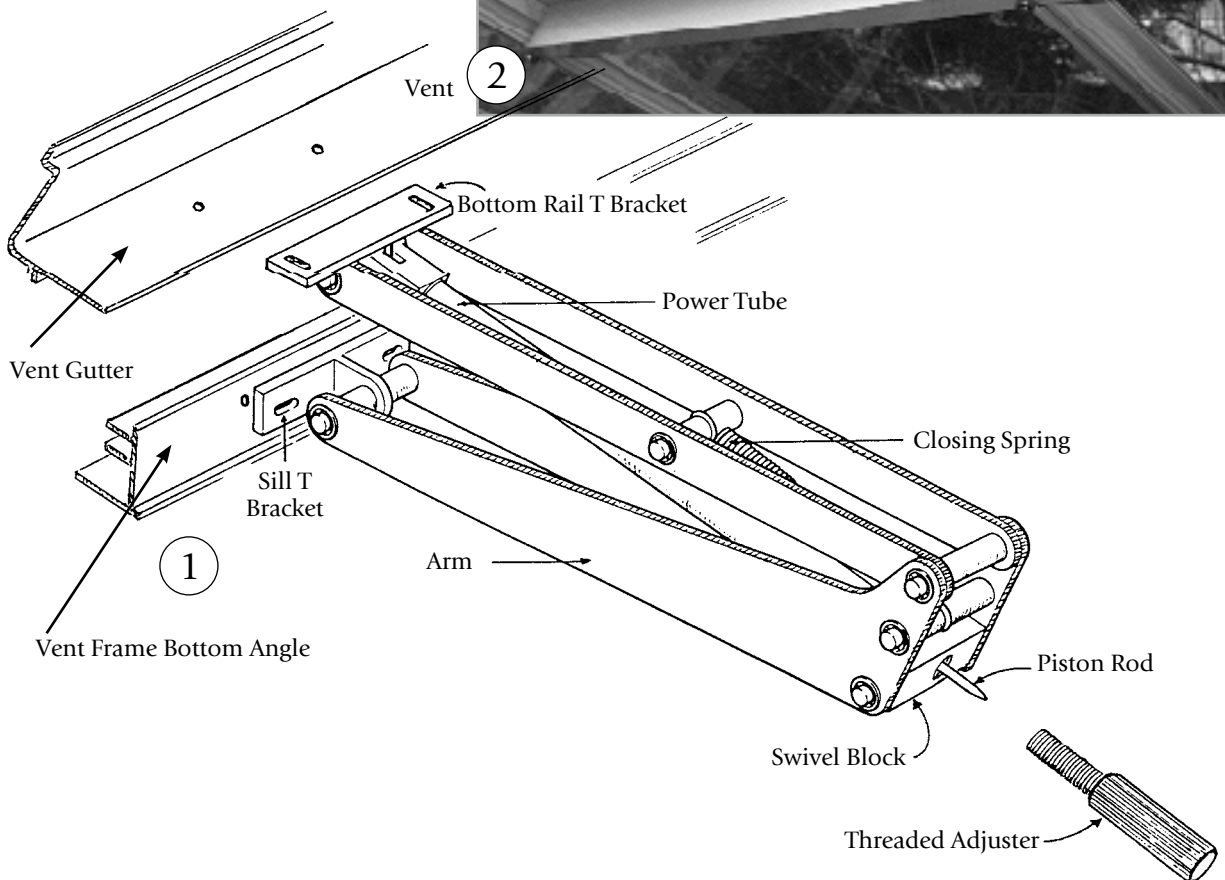
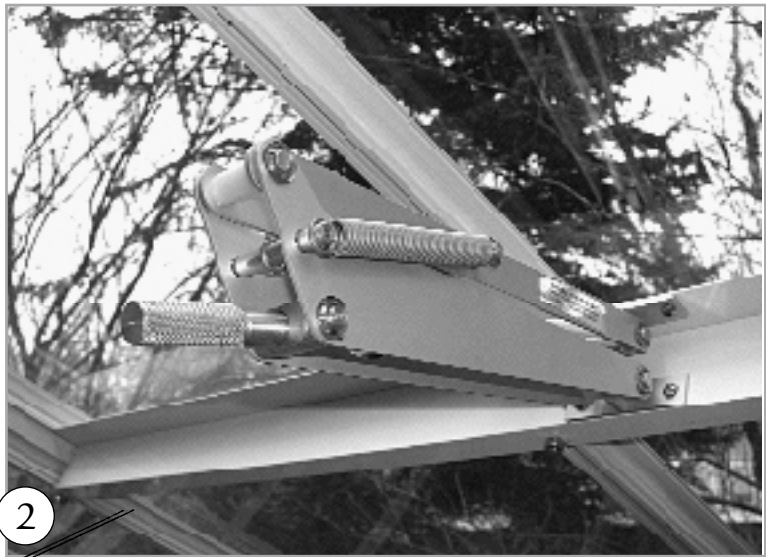

# Vent Assembly - Exploded View

- ALL BOLTS SHOWN ARE  $\frac{3}{8}$ " LONG
- ALL FACE CAP SCREWS ARE  $\frac{1}{4}$ " LONG
- GUTTER END SCREWS ARE  $\frac{3}{8}$ " LONG
- VENT HINGE END SCREWS ARE 1" LONG

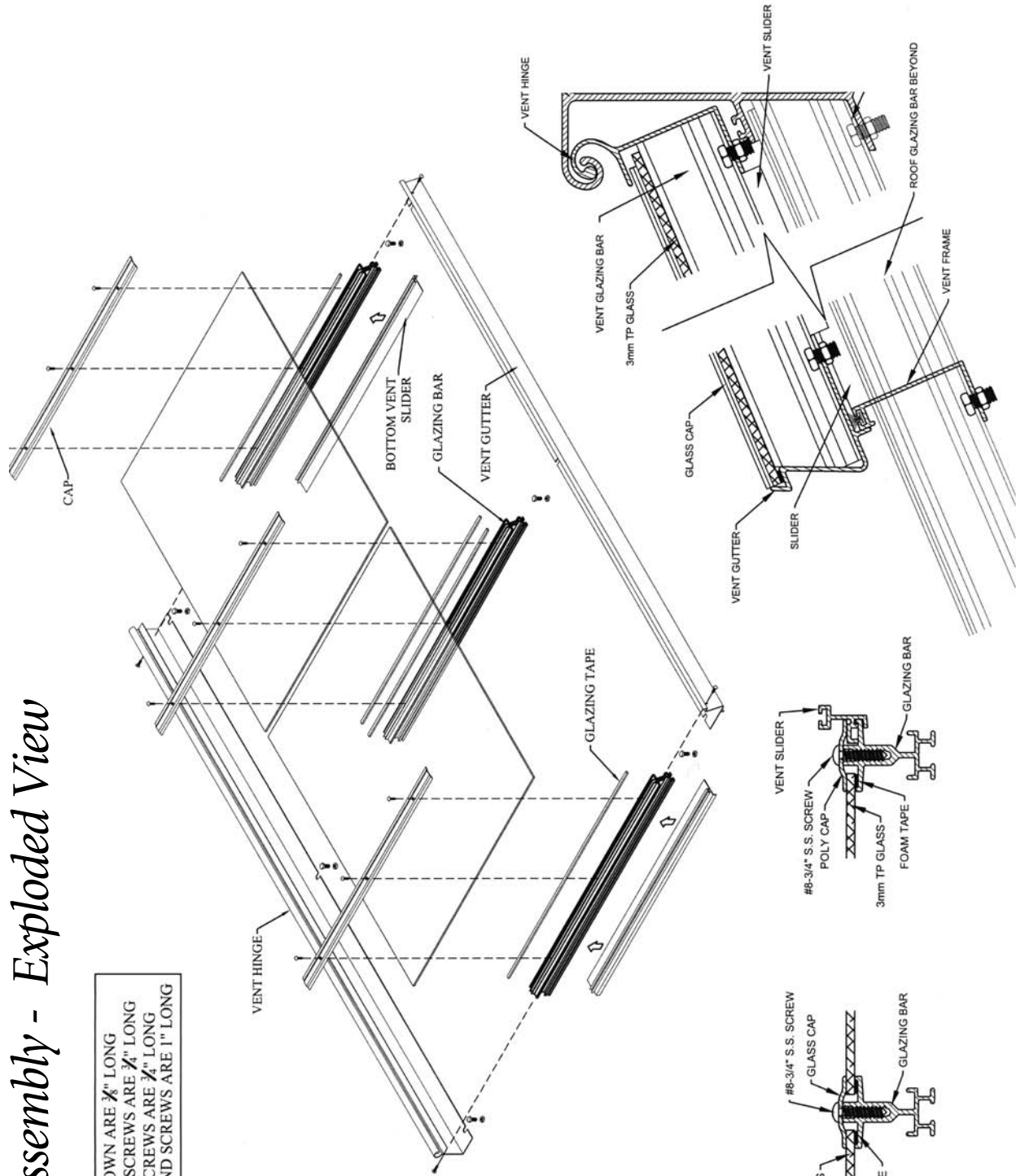

# *Glass Greenhouse Roof Vent Details*

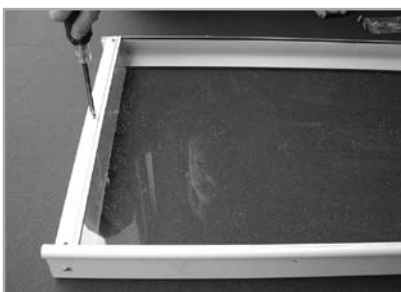
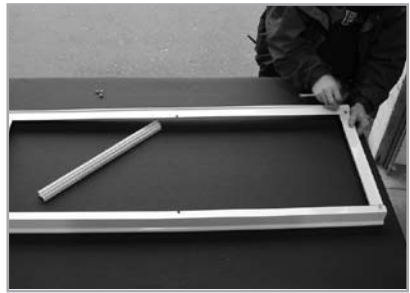
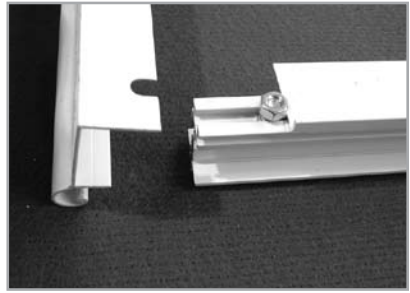
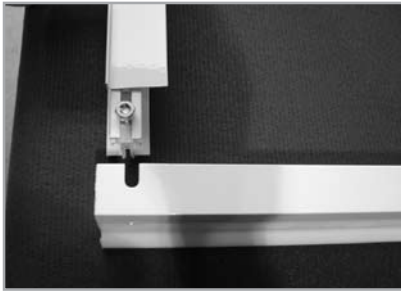
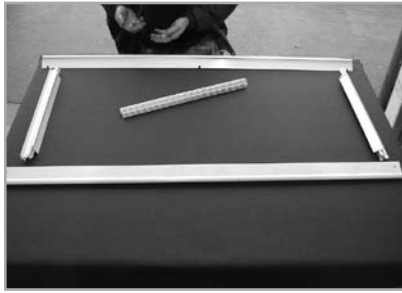

# Sketches

LEAN TO			
STANDARD DIMENSIONS			
Model #	A	B	H
#500 L	4'-4 <sup>3</sup> / <sub>8</sub> "	12'-8 <sup>1</sup> / <sub>2</sub> "	7'-8 <sup>5</sup> / <sub>8</sub> "
#700 L	6'-4 <sup>7</sup> / <sub>8</sub> "	12'-8 <sup>1</sup> / <sub>2</sub> "	8'-7 <sup>1</sup> / <sub>8</sub> "
#1000 L	8'-5 <sup>3</sup> / <sub>8</sub> "	12'-8 <sup>1</sup> / <sub>2</sub> "	9'-5 <sup>5</sup> / <sub>8</sub> "
#1100 L	10'-5 <sup>7</sup> / <sub>8</sub> "	12'-8 <sup>1</sup> / <sub>2</sub> "	10'-4 <sup>1</sup> / <sub>8</sub> "

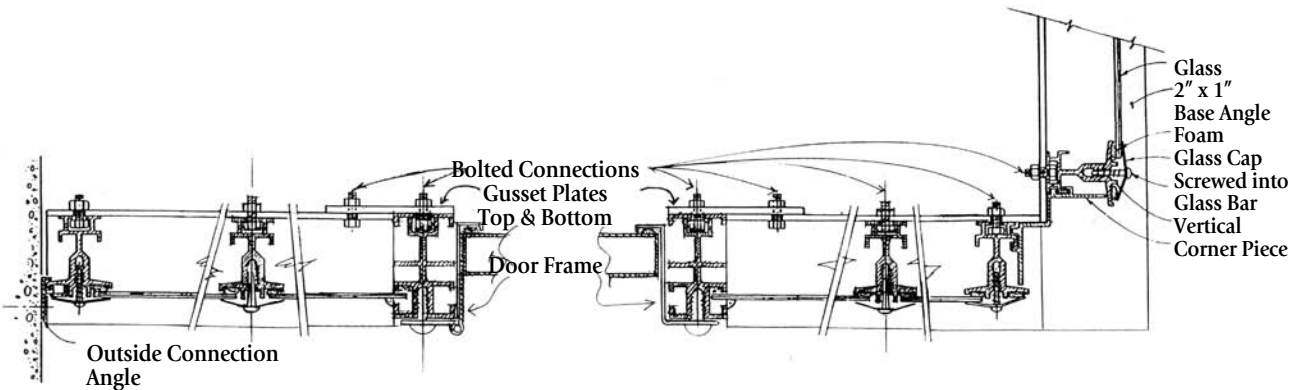
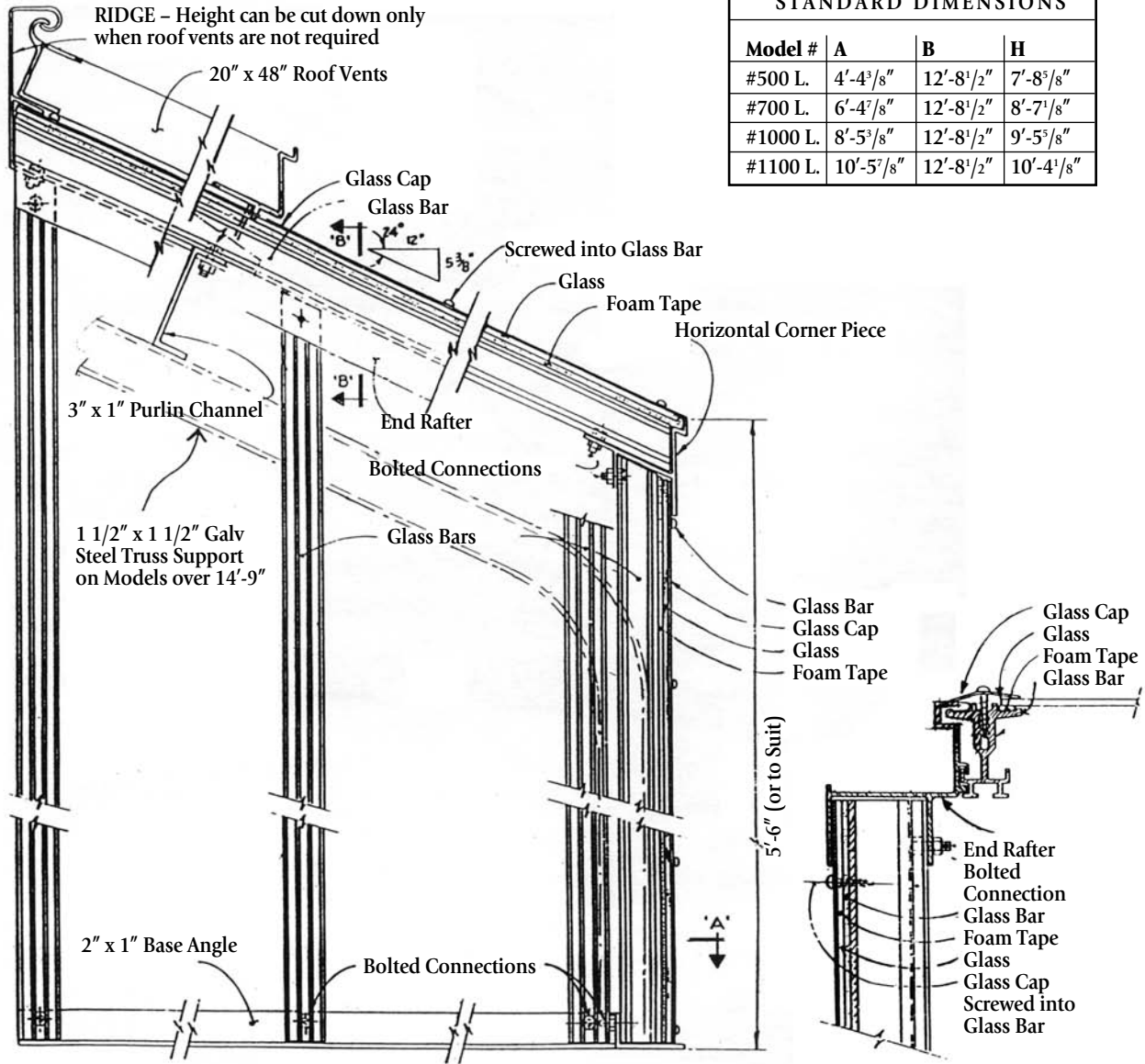

# Appendix A – Straight Truss.

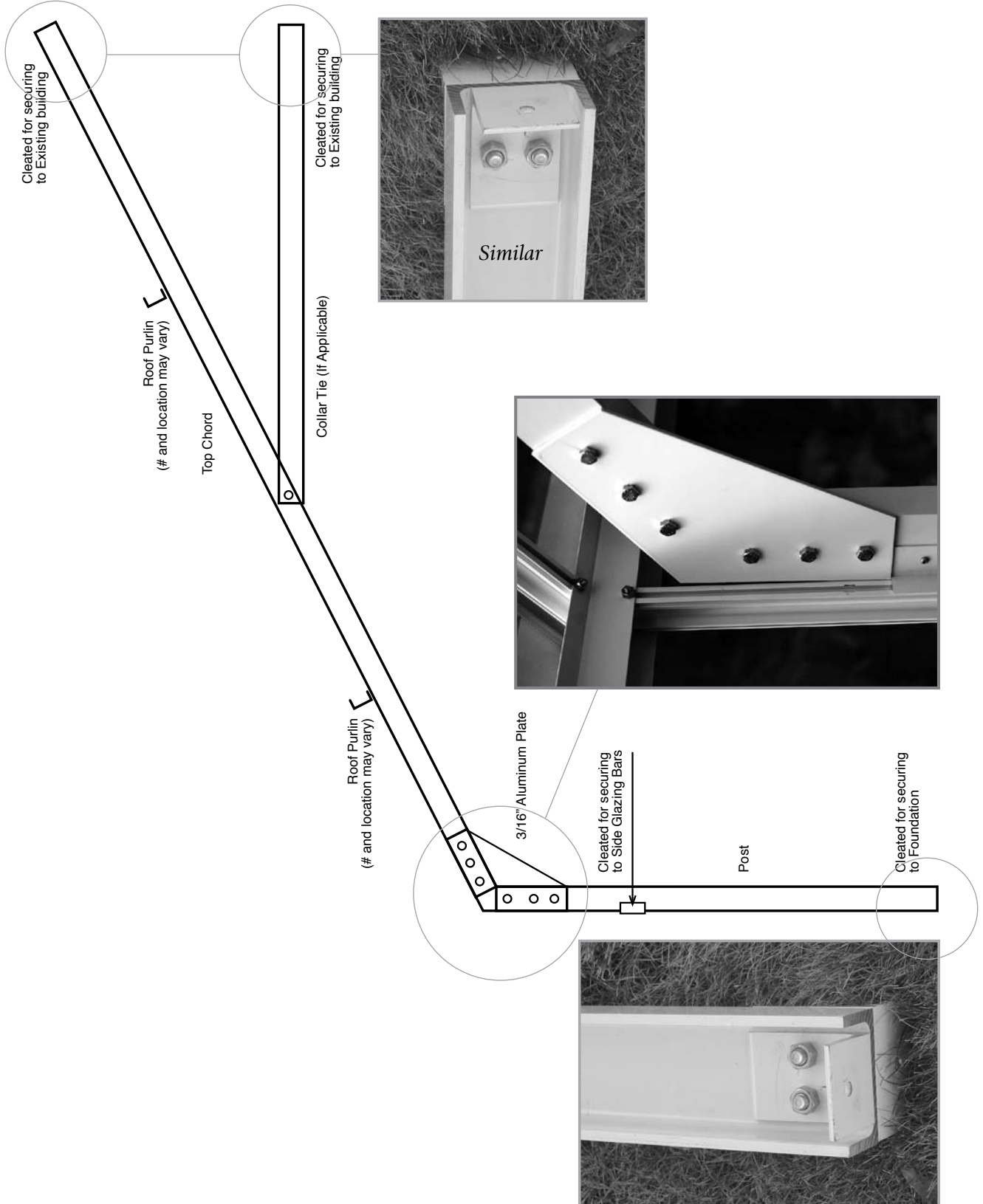



# Appendix B – Motorized Intake Shutter

**NOTE:** Installation of the intake shutter is the same for a glass or polycarbonate greenhouse

- Slide bolts in through notches provided (a small piece of foam stuffed in track under bolt keeps it from sliding down).
- Ensure the blades open with flaps facing down.
- Install glass or polycarbonate on frame of intake shutter.
- Seal around the intake shutter after glass or polycarbonate is installed.

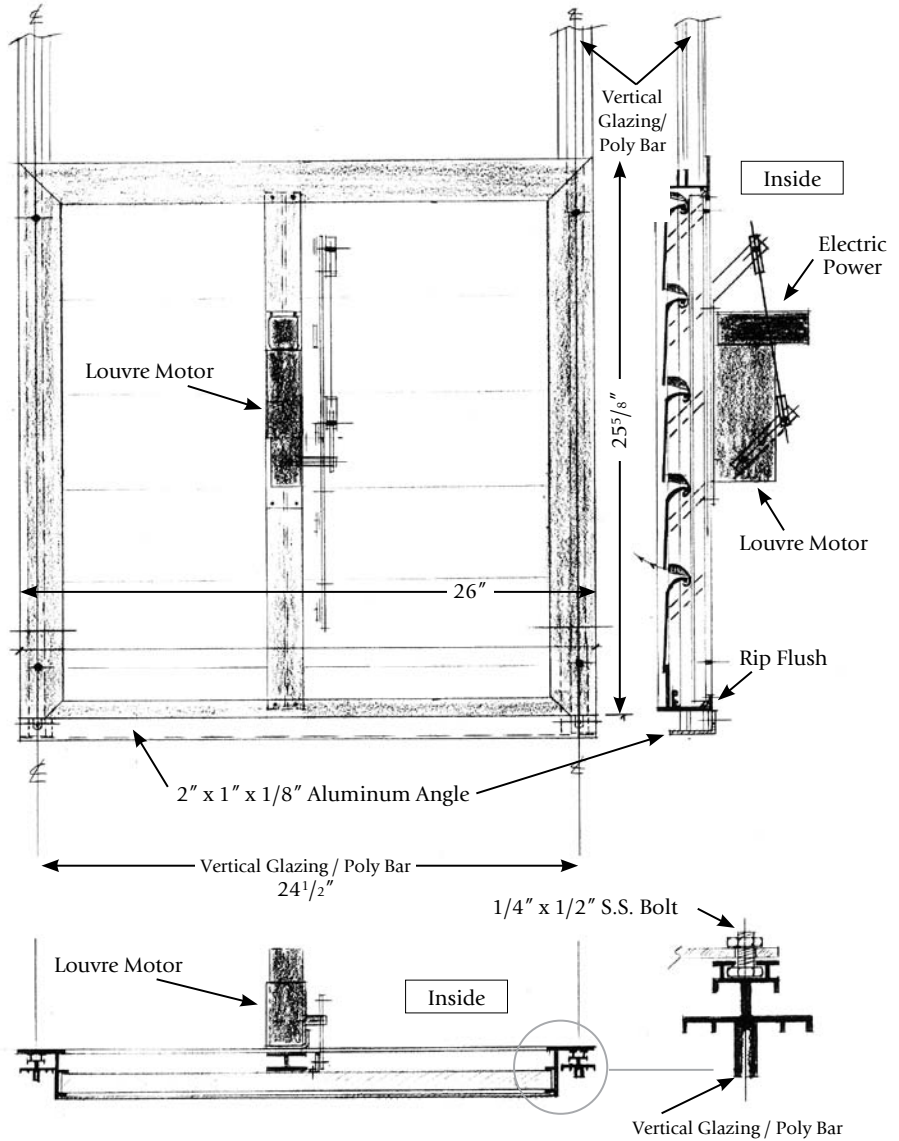

Inside View



# Appendix C – Exhaust Fans

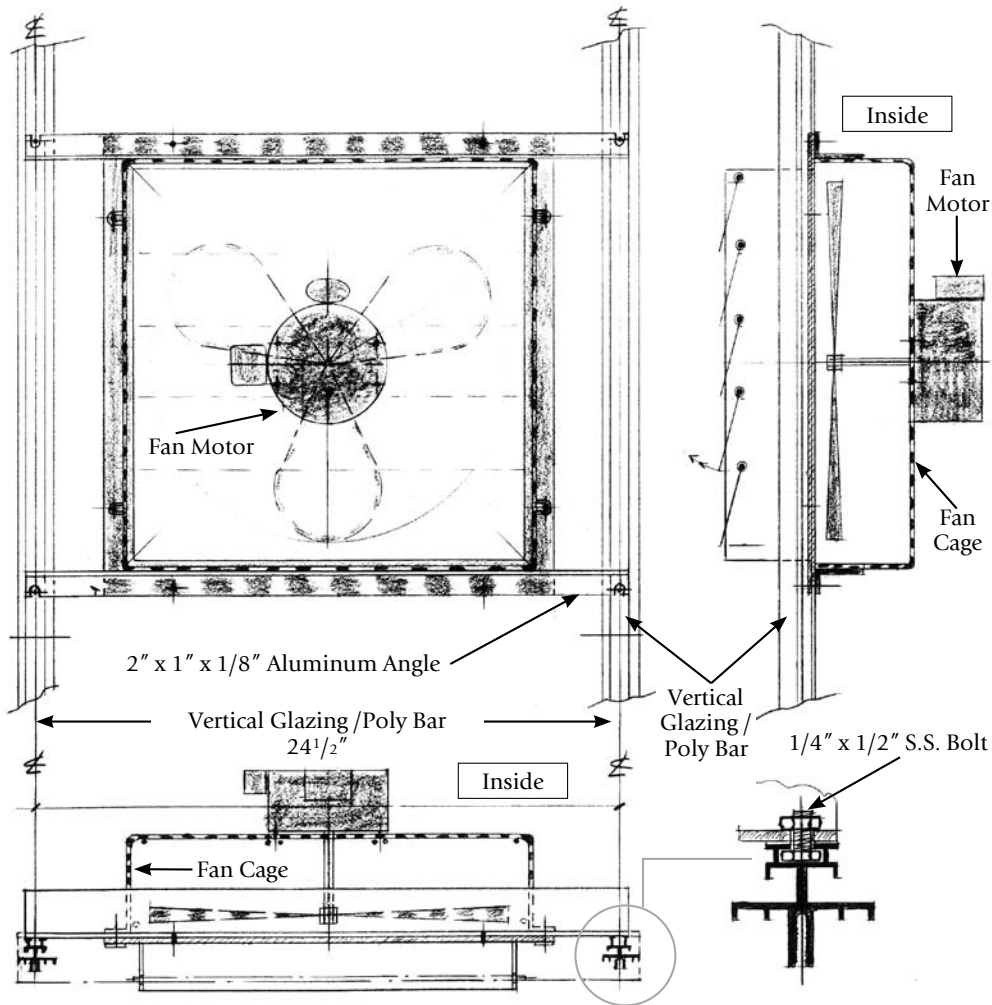

- Slide bolts into vertical bars beside fan bottom.
- Temporarily tighten.
- Insert fan in square cutout of acrylic piece.
- Slide bolts into slots on angle and tighten
- Seal around shutter on outside.



# Appendix D – Side Vent

## GLASS OR POLYCARBONATE SIDE VENT ASSEMBLY

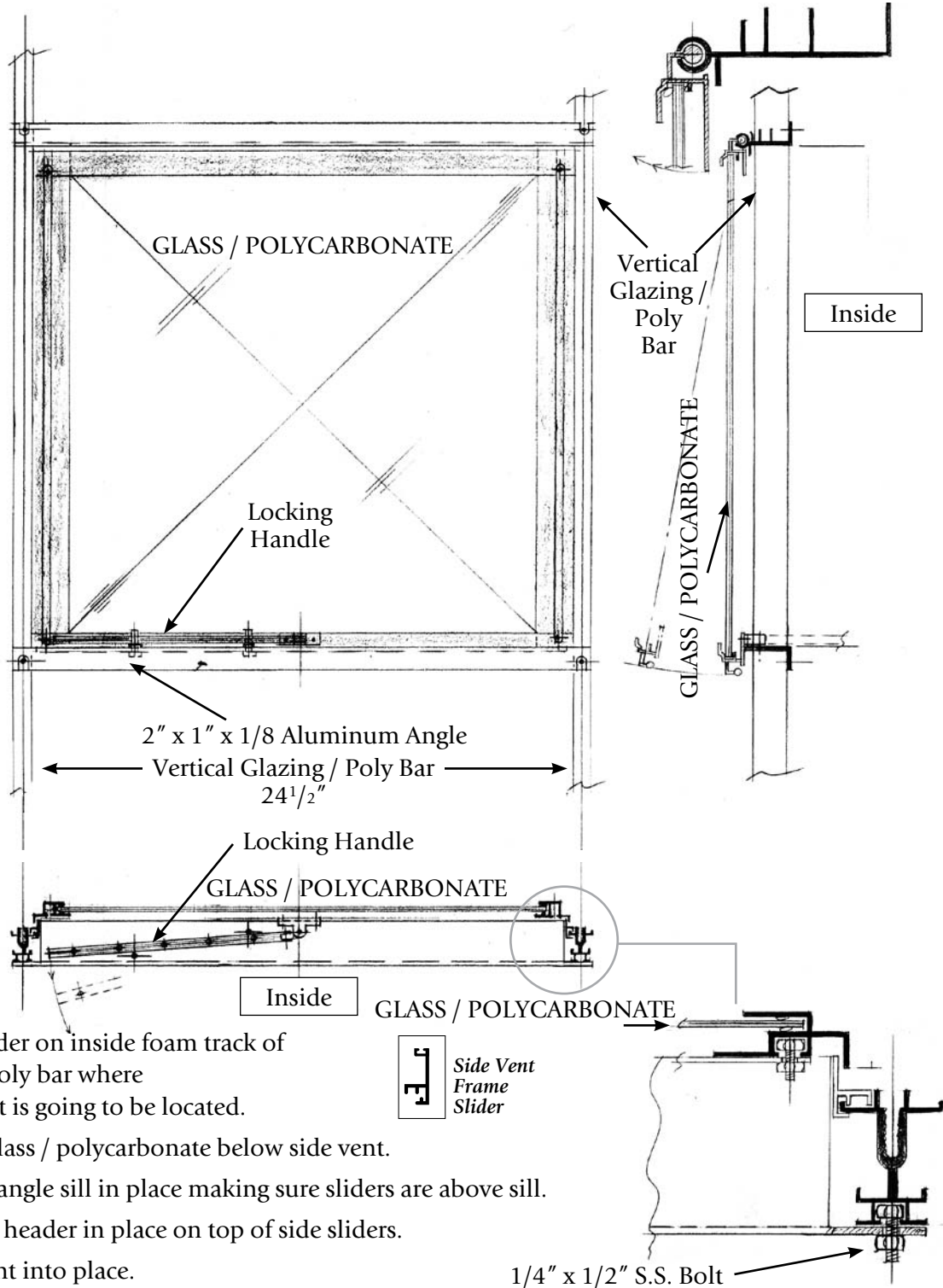

1. Slide slider on inside foam track of glass / poly bar where side vent is going to be located.
2. Install glass / polycarbonate below side vent.
3. Bolt on angle sill in place making sure sliders are above sill.
4. Bolt top header in place on top of side sliders.
5. Slide vent into place.
6. Install automatic or manual opener.

# Appendix D – Side Vent CONTINUED

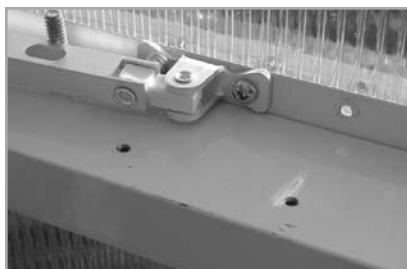
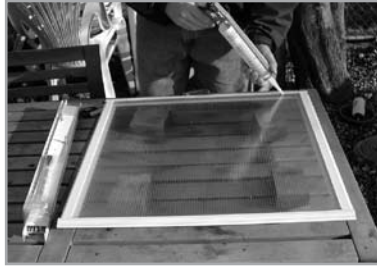
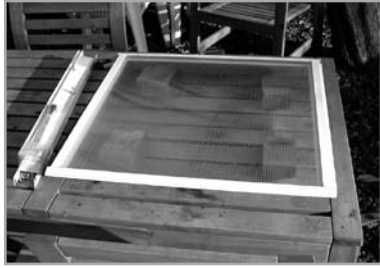

# Appendix E – Glass Louvre

## GLASS OR POLYCARBONATE GLASS LOUVRE ASSEMBLY



# Appendix F – Polycarbonate Panels & Cap Installation

## GENERAL INFORMATION ABOUT HANDLING POLYCARBONATE

All polycarbonate sheets are covered with a thin sheet of plastic on both sides to prevent the sheets from becoming dirty and scratching during handling. One side is a clear plastic while the other side is blue or some other colour, depending on the manufacturer. This latter side should be installed so that it faces out. (**VERY IMPORTANT: The sheet is marked to indicate which side should face out.**)

Before you begin installing, lay out the sheets lengthwise so that it is easier to take the one you want to install. Do the same with the capping.

Remove all the paper on the foam strip on the greenhouse before you begin installing the panels. If the weather is warm and sunny, the foam strips will be sticky. Take a trigger spray bottle and fill it with soap and water. Just before you install the panels, spray the foam lightly so that the panels can be moved around.

***Do not store polycarbonate bundles outside in the sun. Instead, store them in a cool dark place, such as a garage, until you are ready to use them.***

***To clean polycarbonate panels, use soap and water only – do NOT use any chemicals – they will damage the panels.***

## ROOF POLYCARBONATE PANEL INSTALLATION

**NOTE:** When you install the roof panels, start on the far side of the roof vent opening. Work towards the vent opening. When installing the last pieces in the roof you can reach it through the vent opening and do not have to move your ladder outside.

Start with the roof panels. Peel off the plastic. (See Picture 1, page 45) Remember to mark the corner so that you know which side is out (The blue plastic indicates the outside; the clear plastic indicates the inside). Put an aluminum "H" on the bottom of the sheet (Picture 2, page 45).

Then slide the panel into the top track (Picture 3, page 45) and the bottom of the panels with the "H" into the gutter. The long leg of the "H" faces outside (Picture 4). (The gutter should have NO foam on the ledge where the lip of the "H" rests) If the Poly Bars do not line up

with the panel, move the greenhouse ridge toward the front or back until the bars line up. This "squares up" the roof section. Spray the foam with water if it is sticky. The shorter pieces should be placed under the vents. Finish the one side of the roof.

Take the cap, hold it against the panel and position it in the center of the Poly Bar (Pictures 5, 6 & 7, page 47). Use #8 x 1/2" screws and screw it on the Poly Bars (You could use a portable drill with screwbit to do this job, just don't make it too tight). Continue to the next panel and follow the same procedure.

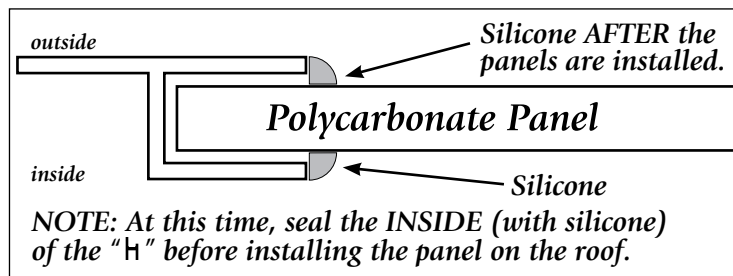

# Appendix F – Polycarbonate Panels & Cap Installation CONTINUED

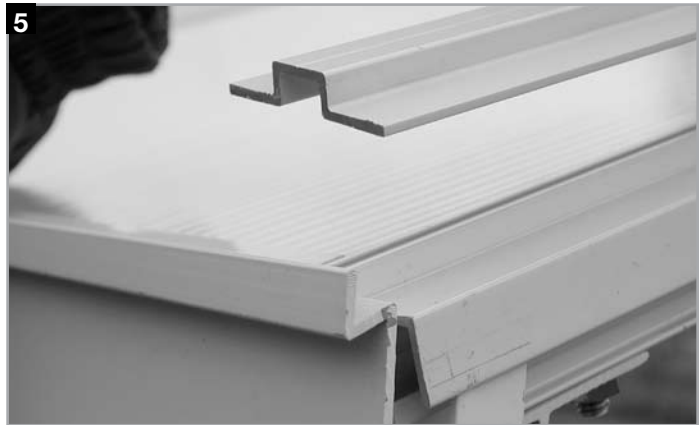

# Appendix G – Perlin Installation

Larger greenhouses have perlin to increase strenght in roof structures. A perlin can be a heavy or light channel. It usually sits on top of a truss and is bolted to the roofbars in the centre of he roof.

Heavy perlin (*at least 1/4" thick*) requires 1/4" x 3/4" bolts. Smaller greenhouses use a light channel – bolts used are the same as the greenhouse bolts, 1/4" x 1/2."

Installation of a perlin is a simple matter of sliding the bolts into the roof bars and fastening the perlin (*see photos*).

Bolt Perlin with the open side facing up if you wish to use it for hanging baskets.

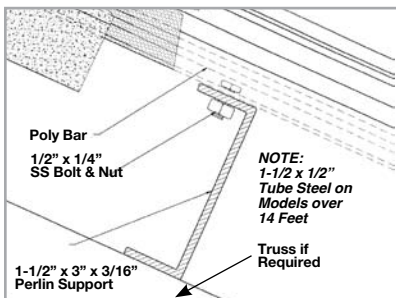
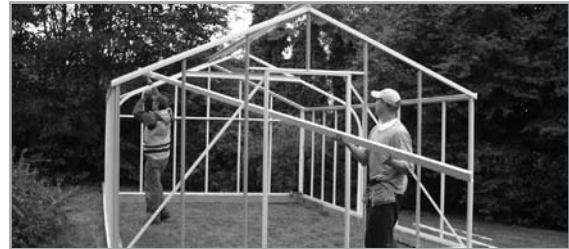
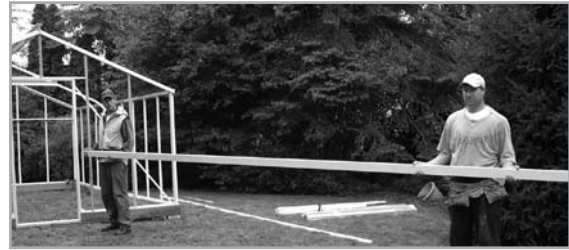



# Appendix H – Greenhouse Bench

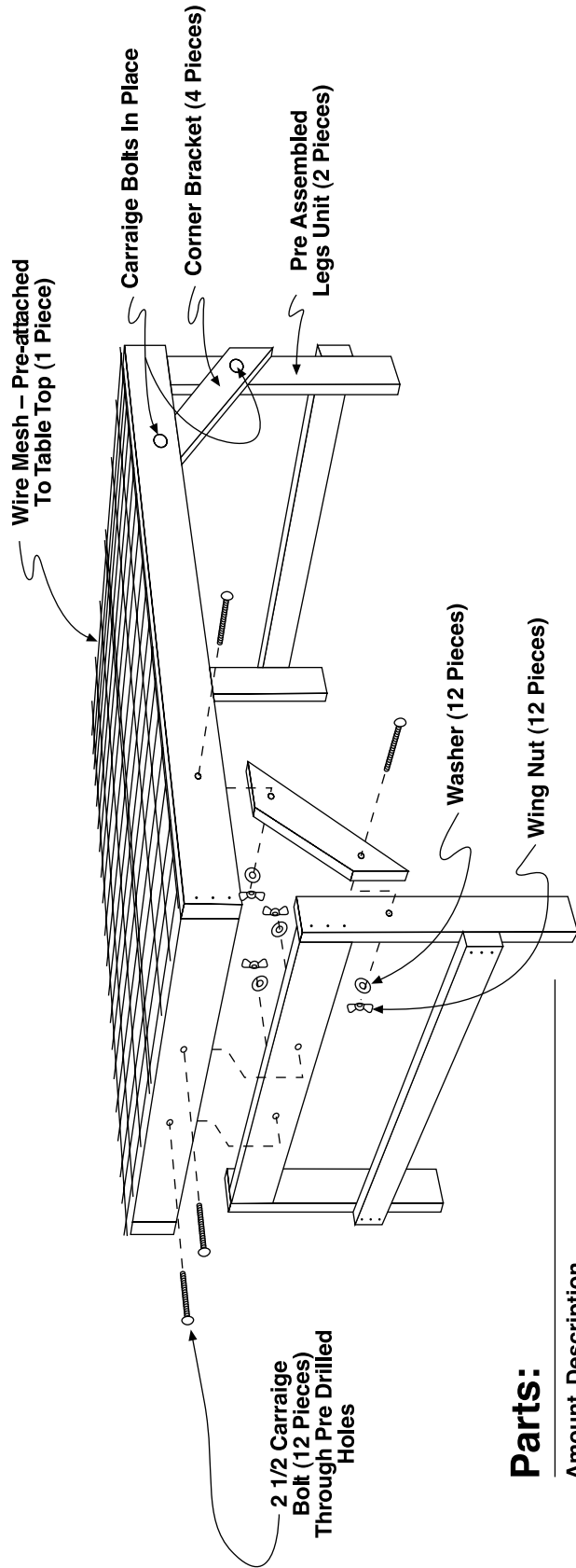

## Parts:

Amount Description

- 1 – Table Top = W/ Pre-attached Wire Mesh  
Plastic Coated W/Guide Holes
- 2 – Leg Units = Pre-assembled W/ Guide Holes
- 4 – Corner Brackets = W/ Guide Holes
- 1 Bag – Contains: 12 – 2 1/2 Carriage Bolts  
12 – Washers  
12 – Wing Nuts

# Appendix I – Roof Vent Screen

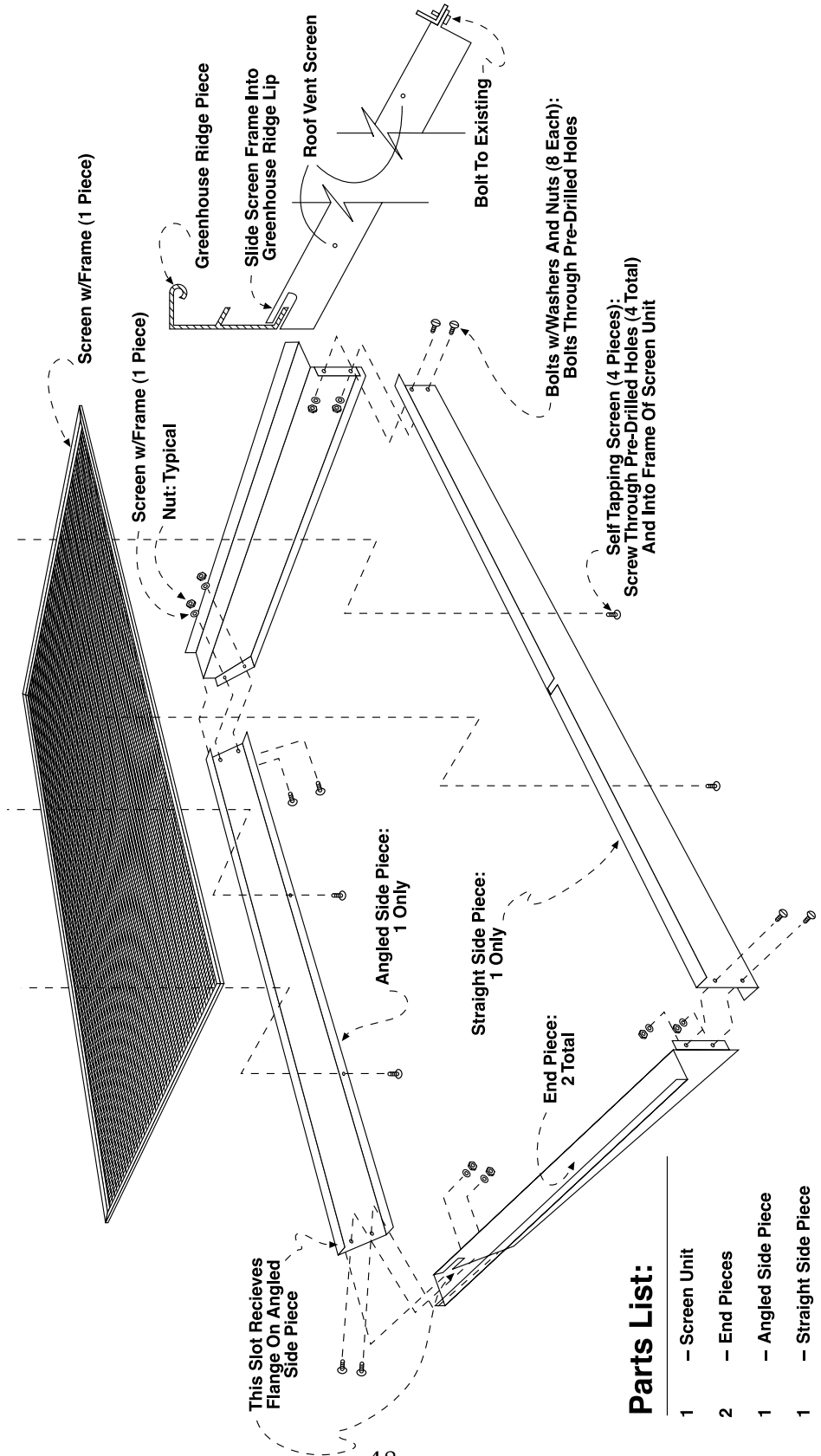

## Parts List:

- 1 – Screen Unit
- 2 – End Pieces
- 1 – Angled Side Piece
- 1 – Straight Side Piece
- 1 Bag With:
  - 8 – Bolts
  - 8 – Washers
  - 8 – Nuts
  - 4 – Self Tapping Screws

# Appendix J – Side Vent Screen

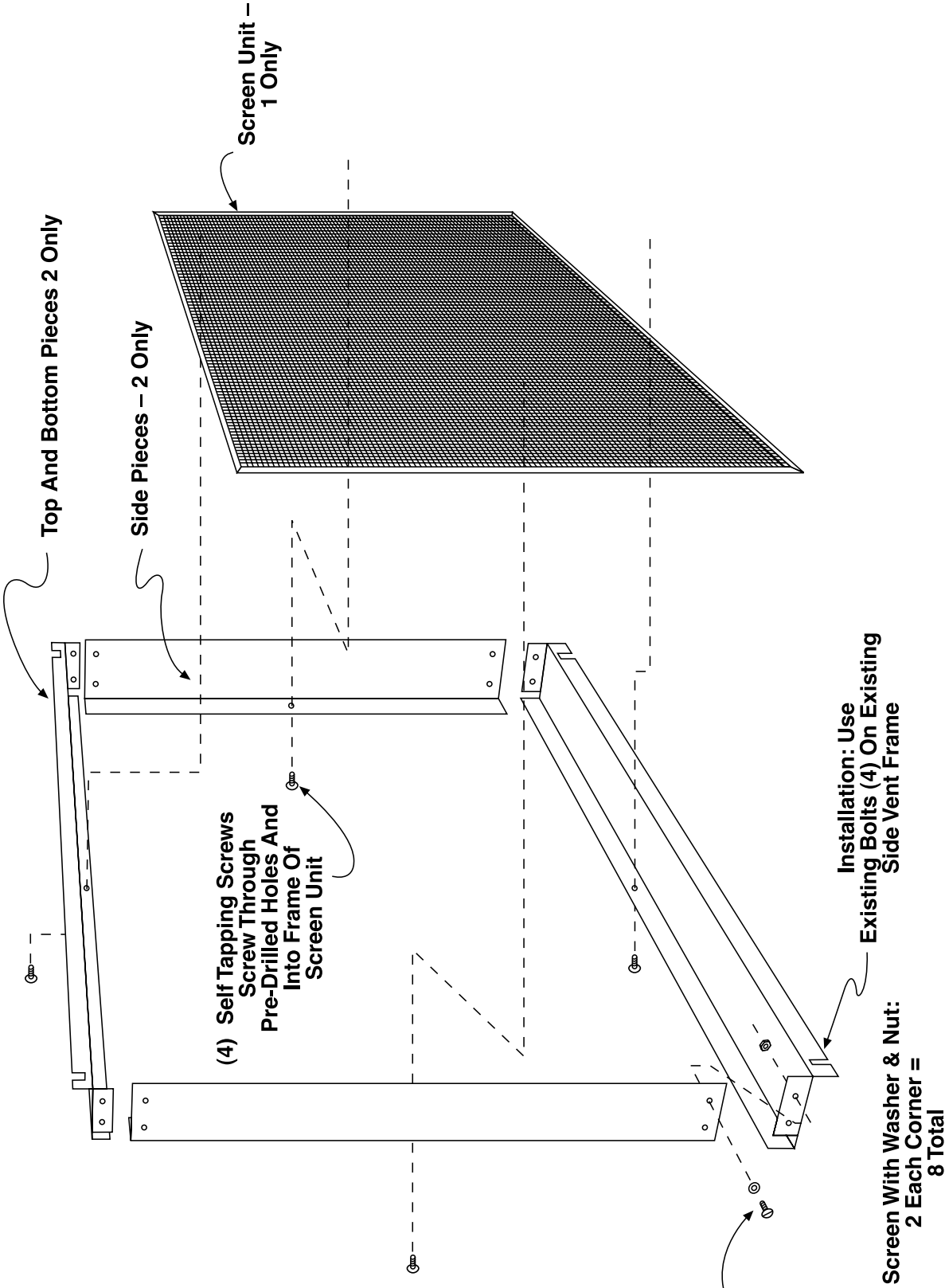

# Appendix K – Wire Shelving

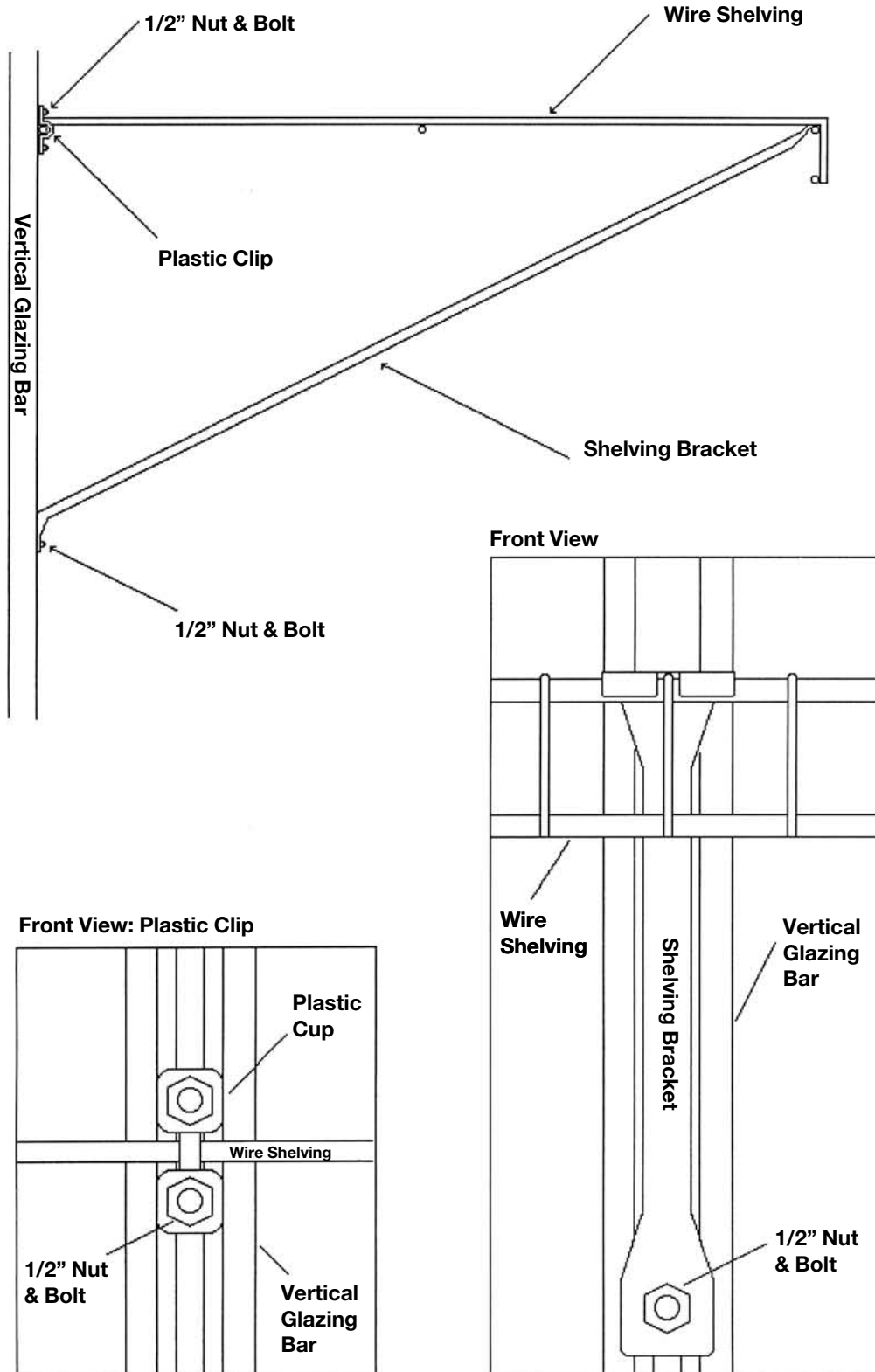

# Miscellaneous Assembly Details – 1

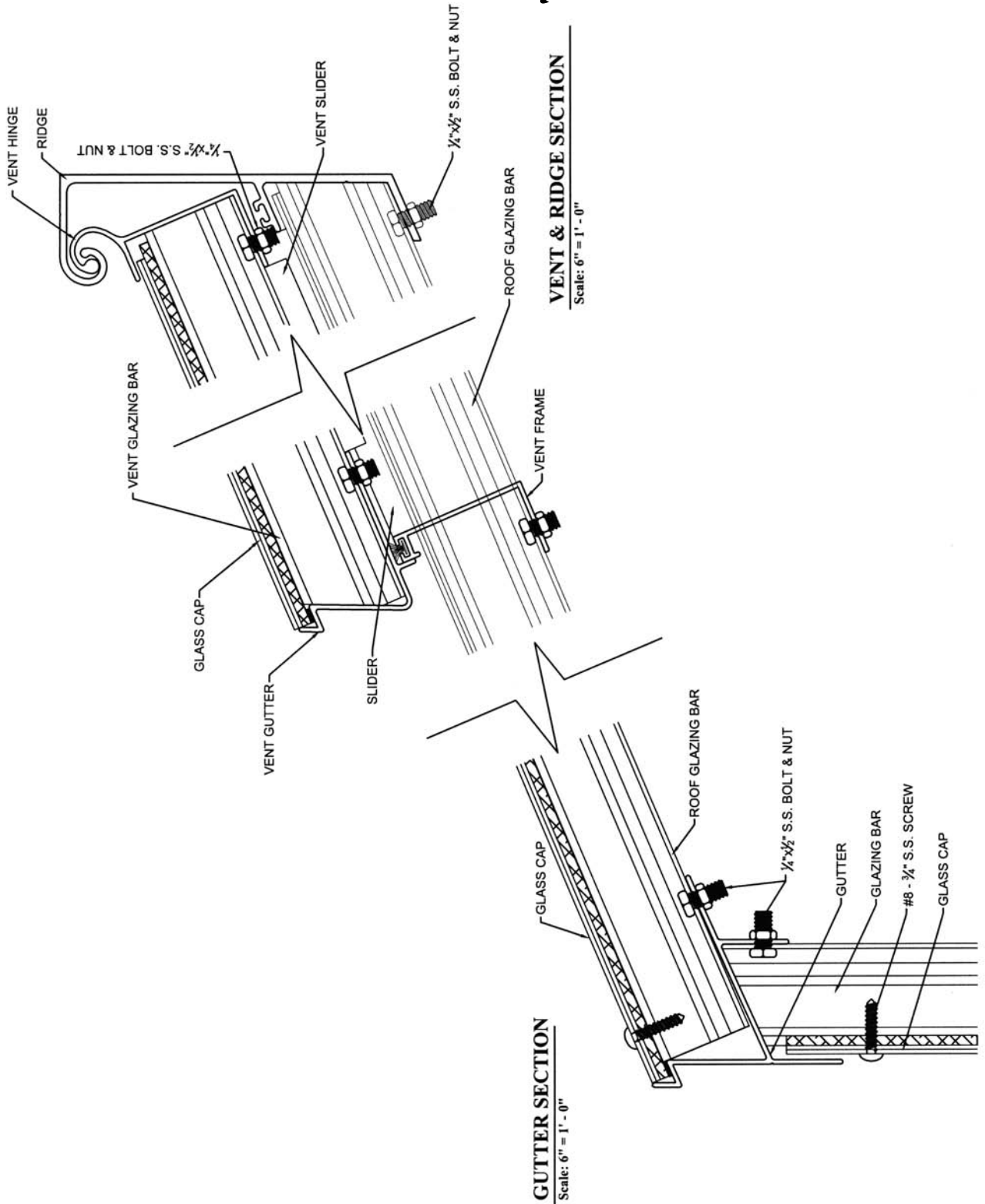

# Miscellaneous Assembly Details – 2

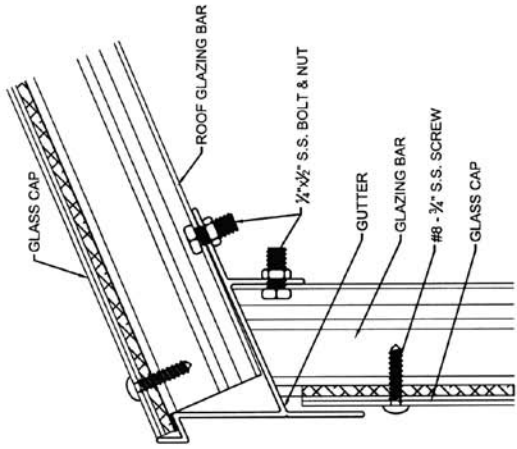

**GUTTER SECTION**  
Scale: 6" = 1' - 0"

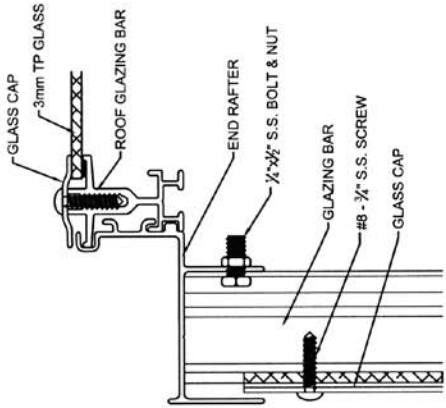

**END RAFTER SECTION**  
Scale: 6" = 1' - 0"

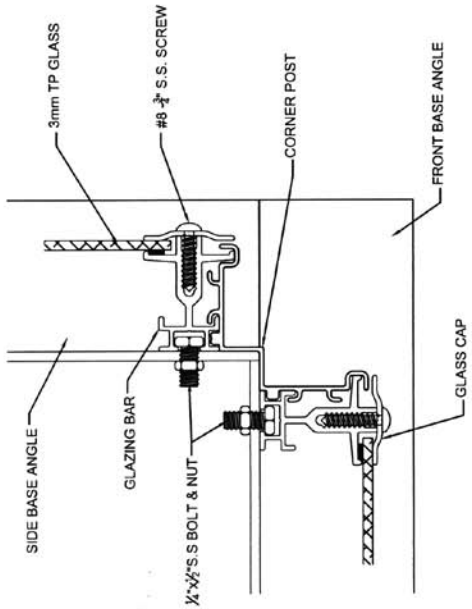

**CORNER POST DETAIL**  
Scale: 6" = 1' - 0"

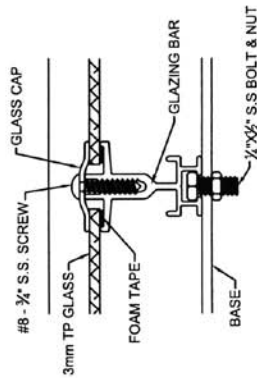

**GLAZING BAR**  
Scale: 6" = 1' - 0"

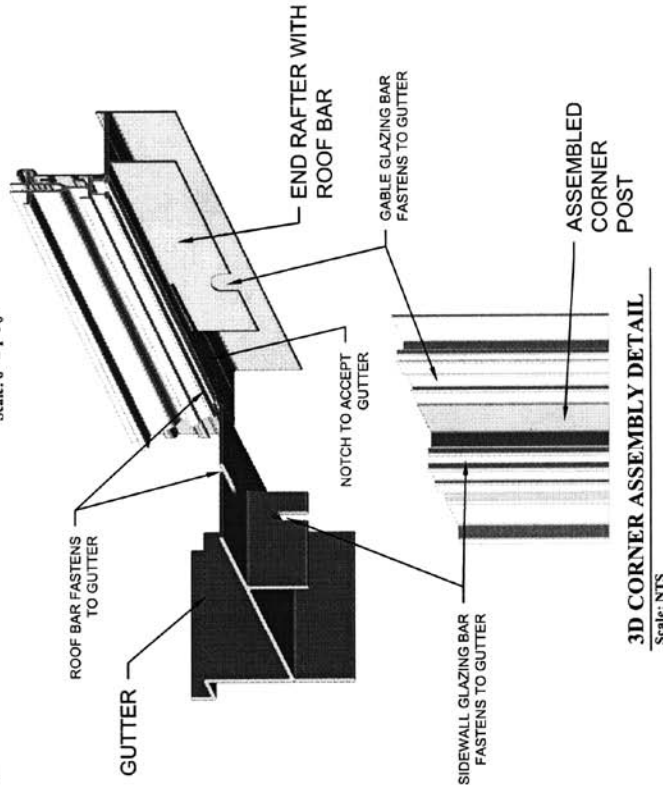

**3D CORNER ASSEMBLY DETAIL**  
Scale: NTS



*At this point, stand back and enjoy your workmanship.*

*Your Traditional Lean To Greenhouse  
should now be closed in and ready for use.*

*Congratulations!*